



**CX300 ComXpert**  
**Communications Service Monitor**  
**Operation Manual**



---

This page intentionally left blank.

**CX300 ComXpert**  
**Communications Service Monitor**  
Operation Manual  
22130634 **Rev. 003**



VIAVI Solutions  
1-844-GO-VIAVI  
[www.viavisolutions.com](http://www.viavisolutions.com)

---

This page intentionally left blank.

---

## Notice

Every effort was made to ensure that the information in this manual was accurate at the time of release. However, information is subject to change without notice, and VIAVI reserves the right to provide an addendum to this manual with information not available at the time that this manual was created.

## Copyright/Trademarks

© Copyright 2022 VIAVI Solutions, Inc. All rights reserved. No part of this guide may be reproduced or transmitted, electronically or otherwise, without written permission of the publisher. VIAVI Solutions and the VIAVI logo are trademarks of VIAVI Solutions Inc. ("VIAVI").

All other trademarks and registered trademarks are the property of their respective owners.

## Patent Information

Patented as described at [www.viavisolutions.com/patents](http://www.viavisolutions.com/patents)

## Copyright Release

Reproduction and distribution of this guide is authorized for US Government purposes only.

## Terms and conditions

Specifications, terms, and conditions are subject to change without notice. The provision of hardware, services, and/or software are subject to VIAVI's standard terms and conditions, available at [www.viavisolutions.com/en/terms-and-conditions](http://www.viavisolutions.com/en/terms-and-conditions).

## Declaration of Conformity

VIAVI recommends keeping a copy of the Declaration of Conformity that shipped with the unit with the test set at all times.

## Warranty Information

Warranty information for this product is available on the VIAVI website at <https://www.viavisolutions.com/en-us/warranty-information>.

## Low Voltage Directive Compliance

This product was tested and conforms to the Low Voltage Directive, 73/23/EEC as amended by 93/68/EEC.

---

## Federal Communications Commission (FCC) Notice

This device complies with part 15 of the FCC Rules. Operation is subject to the following two conditions: (1) This device may not cause harmful interference, and (2) this device must accept any interference received, including interference that may cause undesired operation.

This equipment was tested and found to comply with the limits for a Class A digital device, pursuant to Part 15 of the FCC Rules. These limits are designed to provide reasonable protection against harmful interference when the equipment is operated in a commercial environment. This equipment generates, uses, and can radiate radio frequency energy and, if not installed and used in accordance with the instruction manual, may cause harmful interference to radio communications. Operation of this equipment in a residential area is likely to cause harmful interference, in which case you will be required to correct the interference at your own expense.

The authority to operate this equipment is conditioned by the requirements that no modifications be made to the equipment unless the changes or modifications are expressly approved by VIAVI.



### ALERT

- To comply with FCC RF Exposure compliance requirements, a separation distance of at least 20 cm must be maintained between the antenna of this device and all persons.
- This transmitter must not be co-located in conjunction with any other antenna or transmitter.

---

## Industry Canada Requirements

This device complies with Industry Canada's license-exempt RSSs. Operation is subject to the following two conditions: 1) This device may not cause interference; and, 2) This device must accept any interference, including interference that may cause undesired operation of the device.

Le présent appareil est conforme aux CNR d'Industrie Canada applicables aux appareils radio exempts de licence. L'exploitation est autorisée aux deux conditions suivantes: 1) l'appareil ne doit pas produire de brouillage; et, 2) l'utilisateur de l'appareil doit accepter tout brouillage radioélectrique subi, même si le brouillage est susceptible d'en compromettre le fonctionnement.

## EU WEEE and Battery Directives

This product, and the batteries used to power the product, should not be disposed of as unsorted municipal waste and should be collected separately and disposed of according to your national regulations.

VIAVI has established a take-back processes in compliance with the EU Waste Electrical and Electronic Equipment (WEEE) Directive, 2012/19/EU, and the EU Battery Directive, 2006/66/EC.

Instructions for returning waste equipment and batteries to VIAVI can be found in the WEEE section of [VIAVI's Standards and Policies web page](#).

If you have questions concerning disposal of your equipment or batteries, contact the VIAVI WEEE Program Management team at [WEEE.EMEA@VIAVISolutions.com](mailto:WEEE.EMEA@VIAVISolutions.com).

## EU REACH

Article 33 of EU REACH regulation (EC) No 1907/2006 requires article suppliers to provide information if a listed Substances of Very High Concern (SVHC) is present in an article above a certain threshold.

For information on the presence of REACH SVHCs in VIAVI products, see the Hazardous Substance Control section of [VIAVI's Standards and Policies web page](#).

## EU CE Marking Directives (LV, EMC, RoHS, RE)

This product conforms with all applicable CE marking directives. Please see EU Declaration of Conformity for details.

## EMC Directive Compliance

This product was tested and conforms to the EMC Directive, 2014/30/EU for electromagnetic compatibility.

## UK Declaration of Conformity

This product conforms with all applicable UKCA marking directives. Please request UK Declaration of Conformity for further details.

---

## China RoHS Materials Declaration

The China RoHS Materials Declaration is shipped with the product when required.

## California Proposition 65

California Proposition 65, officially known as the Safe Drinking Water and Toxic Enforcement Act of 1986, was enacted in November 1986 with the aim of protecting individuals in the state of California and the state's drinking water and environment from excessive exposure to chemicals known to the state to cause cancer, birth defects or other reproductive harm.

For the VIAVI position statement on the use of Proposition 65 chemicals in VIAVI products, see the Hazardous Substance Control section of [VIAVI's Standards and Policies web page](#).

## Korea Certification

<p>A급 기기 (업무용 방송통신기자재)</p> <p>Class A Equipment (Industrial Broadcasting &amp; Communications Equipment).</p>	<p>이 기기는 업무용(A급) 전자파적합기기로서 판매자 또는 사용자는 이 점을 주의하시기 바라며, 가정외의 지역에서 사용하는 것을 목적으로 합니다.</p> <p>This equipment is <b>Industrial (Class A) electromagnetic wave suitability equipment</b> and seller or user should take notice of it, and this equipment is to be used in the places except for home.</p>
---	---

## Ordering information

This manual is a product of the VIAVI Technical Publications Department, issued for use with the CX300 ComXpert Communications Service Monitor. The PDF format of this manual is available on the VIAVI product website.

Go to: <https://www.viavisolutions.com/en-us/resources/literature-library>

- Type CX300 to find the manuals associated with the CX300 ComXpert Communications Service Monitor.

## Contact Information

Contact the Technical Assistance Center (TAC) for technical support or with any questions regarding this or other VIAVI products.

- Phone: 1-844-GO-VIAVI
- Email: [Techsupport.Avcomm@viavisolutions.com](mailto:Techsupport.Avcomm@viavisolutions.com)

For the latest TAC information, go to:

<https://www.viavisolutions.com/support/technical-product-support>



## Software Notifications

### DFARS Statement

If software is for use in the performance of a U.S. Government prime contract or subcontract, software is delivered and licensed as “Commercial Computer Software” as defined in DFAR 252.227-7014 (Feb 2014), or as a “Commercial Item” as defined in FAR 2.101(a) or as “Restricted Computer Software” as defined in FAR 52.227-19 (Dec 2007) or any equivalent agency regulation or contract clause. Use, duplication or disclosure of Software is subject to VIAVI Solutions' standard commercial license terms, and non-DOD Departments and Agencies of the U.S. Government will receive no greater than Restricted Rights as defined in FAR 52.227-19(c)(1-2) (Dec 2007). U.S. Government users will receive no greater than Limited Rights as defined in FAR 52.227-14 (June 1987) or DFAR 252.227-7015 (b)(2) (November 1995), as applicable in any technical data.

### Open Source Disclaimer - IMPORTANT READ CAREFULLY

The CX300 ComXpert Communications Service Monitor includes third party software licensed under the terms of separate open source software licenses. By using this software you agree to comply with the terms and conditions of the applicable open source software licenses. Software originated by VIAVI is not subject to third party licenses. Terms of the VIAVI Software License different from applicable third party licenses are offered by VIAVI alone.

This page intentionally left blank.

---

# Safety and Compliance Information









Read and follow all warning notices and instructions marked on the product and included in user documentation.

## Symbols and Markings

The following symbols and markings are found on the instrument and in product documentation:

**Table 1 Symbols and Markings**

---

	This symbol indicates a note that includes important supplemental information or tips related to the main text.
	<b>Attention Symbol</b> This symbol represents a general hazard. It may be associated with either a DANGER, WARNING, CAUTION, or ALERT message. <a href="#">See Table 2</a> for more information.
	<b>ESD Sensitive</b> Indicates item is static sensitive. Item should only be handled by Qualified Service Personnel.
	<b>Explosive Hazard</b> This symbol represents a risk of explosion. It may be associated with either a DANGER, WARNING, CAUTION or ALERT message.
	<b>Voltage Symbol</b> This symbol represents hazardous voltages. It may be associated with either a DANGER, WARNING, CAUTION, or ALERT message. <a href="#">See Table 2</a> for more information.
	<b>Toxic Symbol</b> Indicates a toxic hazard. Item should only be handled by Qualified Service Personnel. Dispose of item in accordance with local regulations.
	<b>WEEE Symbol</b> This symbol, located on the equipment or the packaging indicates that the equipment must not be disposed of in a land-fill site or as municipal waste, and should be disposed of according to your national regulations.
	<b>CE Compliant</b> CE Label indicates item meets the requirements of the applicable European Directives.
	<b>Fuse Symbol</b> Indicates a fuse location (AC or DC).

---

## Safety Definitions

This manual uses the following terms to indicate conditions or activities which are potential safety hazards:

**Table 2 Safety Definitions**

Term	Definition
<b>WARNING</b>	Identifies conditions or activities that, if ignored, can result in personal injury or death.
<b>Avertissement</b>	Identifiez les conditions ou les activités qui, si ignorées, peuvent entraîner des blessures personnelles voire mortelles.
<b>CAUTION</b>	Identifies conditions or activities that, if ignored, can result in equipment or property damage, e.g., Fire.
<b>Mise en Garde</b>	Identifiez les conditions ou les activités qui, si ignorées, peuvent entraîner des dommages à l'équipement ou aux biens, p. ex. un incendie.

## Safety Hazards

### Toxic Hazards



#### **WARNING**

Some of the components used in this device may include resins and other materials which give off toxic fumes if incinerated. Dispose of such items appropriately.

#### **Avertissement**

Certains des composants utilisés dans cet appareil peuvent comprendre des résines et d'autres matériaux qui produisent des émanations toxiques lorsqu'ils sont incinérés. Éliminez adéquatement de tels éléments.



#### **WARNING**

A Lithium-Ion battery is used in this equipment. Lithium is a toxic substance.

- Do not crush, incinerate or dispose of in normal waste.
- Do not short circuit or force discharge since this might cause the battery to vent, overheat or explode.

---

## WEEE and Battery Statement

This product and the batteries used to power the product, should not be disposed of as unsorted municipal waste and should be collected separately and disposed of according to local regulations.

VIAVI has established a take-back processes in compliance with the EU Waste Electrical and Electronic Equipment (WEEE) Directive, 2012/19/EU, and the EU Battery Directive, 2006/66/EC.

Information and instructions for returning waste equipment and batteries to VIAVI can be found on the VIAV website in the WEEE section of VIAVI's Standards and Policies web page at: [VIAVI's Standards and Policies](#) web page.

## Beryllia



### WARNING

Beryllia (beryllium oxide) is used in the construction of some of the components in this equipment.

This material, when in the form of fine dust or vapor and inhaled into the lungs, can cause a respiratory disease. In its solid form, as used here, it can be handled safely, however, avoid handling conditions which promote dust formation by surface abrasion.

Use care when removing and disposing of these components. Do not put them in the general industrial or domestic waste or dispatch them by post. They should be separately and securely packed and clearly identified to show the nature of the hazard and then disposed of in a safe manner by an authorized toxic waste contractor.

---

## Beryllium Copper



### WARNING

Some mechanical components within this instrument are manufactured from beryllium copper. Beryllium copper represents no risk in normal use. The material should not be machined, welded or subjected to any process where heat is involved.

Beryllium copper must NOT be disposed of by incineration. Beryllium copper must be disposed of as “special waste” per local regulations.

## Lithium-Ion



### WARNING

A Lithium-Ion battery is used in this device. Lithium-Ion is a toxic substance, so the battery should in no circumstances be crushed, incinerated or disposed of in normal waste.

- Do not attempt to recharge this type of battery.
- Do not short circuit or force discharge since this might cause the battery to vent, overheat or explode.



### CAUTION

This device contains a Lithium-Ion battery and may require special packaging and external labeling when shipping. Contact VIAVI for packaging and labeling instructions.

### Mise en Garde

Cet appareil contient une batterie au lithium-ion et peut nécessiter un emballage spécial et un étiquetage externe lors de l'expédition. Contactez VIAVI pour l'emballage et les instructions étiquetantes.

---

# Electrical Hazards

## Grounding the Instrument

The instrument is provided with a protective grounding lead that conforms with IEC Safety Class I. The supply lead must always be connected to the power supply via a grounded contact in order to maintain the grounding protection. The instrument must be properly grounded to prevent damage to the device from electrostatic discharge (ESD).



### **WARNING**

Improper grounding of equipment can result in electrical shock. To ensure proper grounding, this device should only be connected to a grounded AC Power Supply.

### **Avertissement**

La mise à la terre inadéquate de l'équipement peut entraîner un choc électrique. Pour s'assurer d'une mise à la terre adéquate, cet appareil doit seulement être branché à une alimentation électrique CA mise à la terre.

## Input Overload

Refer to product labeling and product specifications for maximum input ratings.



### **CAUTION**

Do not overload input connectors. Refer to product specifications or the product data sheet for maximum input ratings.

### **Mise en Garde**

Ne surchargez pas les connecteurs d'entrée. Reportez-vous aux spécifications du produit ou à la fiche technique du produit pour connaître les valeurs d'entrée maximales.

## AC Power Adapter/Cord

Approved Part: 22142972, AC Power Adapter/Cord.

The base unit with all applications installed can operate supplied by the 19 V DC, 160 W AC power adapter/cord that is shipped with the unit.

The mains supply cord used with the power adapter must be grounded with a connection to protective earth.



### CAUTION

- Only use the AC Power Adapter/Cord supplied with the instrument.
- Do not use the AC Power Adapter/Cord outdoors or in a wet or damp location.
- Only connect the AC Power Adapter/Cord to the correct mains voltage indicated on the ratings label.
- Do not use the AC Power Adapter/Cord if it appears damaged or modified.

### Mise en Garde

- Utilisez uniquement l'adaptateur secteur / le cordon d'alimentation fourni avec l'instrument.
- N'utilisez pas l'adaptateur secteur / le cordon d'alimentation à l'extérieur ou dans un endroit mouillé ou humide.
- Connectez uniquement l'adaptateur secteur / cordon d'alimentation à la tension secteur appropriée indiquée sur l'étiquette des caractéristiques nominales.
- N'utilisez pas l'adaptateur / cordon d'alimentation secteur s'il semble endommagé ou s'il a été modifié.



Figure 1 AC Power Adapter Label





### **CAUTION**

- Do not use the power cord if it is damaged or frayed. Replace damaged power cords with cable of the same ratings.
- Do not position the power cord in a manner that makes it difficult to disconnect from the main voltage.
- Do not allow anything to rest on the power cord.
- Do not locate the product where persons can walk on or trip over the power cord.

### **Mise en Garde**

- N'utilisez pas le cordon d'alimentation s'il est endommagé ou effiloché. Remplacez les cordons d'alimentation endommagés par des câbles de même puissance.
- Ne placez pas le cordon d'alimentation de manière à rendre difficile la déconnexion de la tension secteur.
- Ne laissez rien reposer sur le cordon d'alimentation.
- Ne placez pas le produit à un endroit où des personnes pourraient marcher ou trébucher sur le cordon d'alimentation.

## **Residual Current**



### **WARNING**

The supply filter contains capacitors that may remain charged after the instrument is disconnected from the power supply. The residual energy is within the approved safety requirements, however, a slight shock may be felt if the plug pins are touched immediately after removal.

### **Avertissement**

Le filtre d'alimentation contient des condensateurs qui peuvent rester chargés une fois l'appareil débranché de l'alimentation électrique. L'énergie résiduelle est dans les limites des exigences de sécurité approuvées. Par contre, un léger choc électrique peut être ressenti si l'on touche les broches de la prise immédiatement après son débranchement.

---

## Battery Safety Information

There are two batteries included with the product, and are only to be used with VIAVI CX300 ComXpert.

### Battery Storage, Handling and Disposal



#### CAUTION

- To avoid risk of fire and burns, do not tamper with the batteries.
- Do not open, crush, or incinerate the batteries.
- Do not use or store the batteries in temperatures that exceed product specifications.
- Avoid shorting the batteries.
- Never use a battery that appears damaged or abused.
- Only charge the batteries with the charger that shipped with the test set.

#### Mise en Garde

- Ne pas ouvrir, écraser ni incinérer la batteries.
- N'utilisez pas et ne stockez pas la batteries à des températures dépassant les spécifications du produit.
- Évitez de court-circuiter la batteries.
- N'utilisez jamais une batterie qui semble endommagée ou qui a subi des abus.
- Accusez seulement la batteries du chargeur qui a expédié avec le jeu d'essai.

### Battery Replacement

Approved Part Number: 22116266, Rechargeable Lithium Ion Battery



#### CAUTION

The two batteries supplied with the device should only be replaced with a replacement part that has been approved by VIAVI.

#### Mise en Garde

La deux batteries fournie avec l'appareil ne doit être remplacée que par une pièce de rechange approuvée par VIAVI.

---

## Equipment Usage

This device is designed and tested to comply with the requirements of 'IEC/EN 61010-1, 3rd Edition Safety Requirements for Electrical Equipment for Measurement, Control and Laboratory Use' for Class I portable equipment and is for use in a pollution degree 2 environment.



### **WARNING**

Operating this device in a manner not specified in accompanying documentation may impair the safety protection built into the device.

### **Avertissement**

Utiliser cet appareil de manière non spécifiée dans la documentation d'accompagnement peut nuire au dispositif de protection de sécurité intégré dans l'appareil.

## Electrostatic Discharge (ESD)



### **CAUTION**

Internal components are ESD sensitive and should only be installed, removed and/or serviced by Qualified Service Personnel.

### **Mise en Garde**

Les composants internes sont sensibles au DES et ne doivent être installés, retirés ou entretenus que par du personnel de maintenance qualifié.

## Case/Cover Removal

Do not operate this device with the case or covers removed. Opening or removing covers may expose you to dangerous high voltage points and other hazards.



### **CAUTION**

This device does not contain user serviceable parts. Servicing should only be performed by Qualified Service Personnel.

### **Mise en Garde**

Cet appareil ne contient pas de pièces pouvant être entretenues par l'utilisateur. L'entretien doit seulement être effectué par du personnel de service qualifié.

---

## Ventilation Requirements

The instrument is cooled by internal fans. Failure to provide proper ventilation may result in damage to the instrument. Observe the following precautions when operating the instrument:



### CAUTION

- Do not obstruct air flow to the air vents.
- Do not place the instrument on or close to other heat-generating equipment.
- Do not operate device in an enclosure such as the soft-shell travel case.

### Mise en Garde

- N'obstruez pas l'écoulement d'air vers les événements.
- Ne placez pas l'instrument sur ou près de tout autre équipement générant de la chaleur.
- N'utilisez pas l'appareil dans un boîtier tel que l'étui de voyage à coque souple.

## Electromagnetic Interference (EMI)

This product complies with Part 15 of the FCC Rules for a Class A device. Operation is subject to the following two conditions: (1) this product may not cause harmful interferences, and (2) this product must accept any interferences received, including interference that may cause undesired operation.

These limits are designed to provide reasonable protection against harmful interference in a residential installation. This product generates, uses, and can radiate radio frequency energy and, if not installed and used in accordance with the instructions, may cause harmful interference to radio communications. However, there is no guarantee that interference will not occur in a particular installation.

If this product does cause harmful interference to radio or television reception, which can be determined by turning the equipment off and on, the user is encouraged to try to correct the interference by one or more of the following measures:

- Reorient or relocate the receiving antenna.
- Increase the separation between the equipment and receiver.
- Connect the equipment into an outlet on a circuit different from that to which the receiver is connected.
- Use properly shielded and grounded cables and connectors in order to meet FCC emission limits.



## **CAUTION**

Signal generators can be a source of Electromagnetic Interference (EMI) to communication receivers. Some transmitted signals can cause disruption and interference to communication services out to a distance of several miles. Users of this equipment should scrutinize any operation that results in radiation of a signal (directly or indirectly) and should take necessary precautions to avoid potential communication interference problems.

### **Mise en Garde**

Les générateurs de signaux peuvent constituer une source d'interférences électromagnétiques (IME) pour les récepteurs radio. Certains signaux émis peuvent provoquer des interférences et des interruptions des communications sur une distance de plusieurs kilomètres. Les utilisateurs de cet équipement doivent examiner soigneusement tout fonctionnement provoquant le rayonnement d'un signal (direct ou indirect) et ils doivent prendre les dispositions nécessaires afin d'éviter des problèmes potentiels d'interférences sur les communications.

---

This page intentionally left blank.



# Table of Contents

	• Software Notifications . . . . .	1-5
<b>Chapter 1</b>	<b>CX300 ComXpert Overview . . . . .</b>	<b>1-1</b>
	1.1 CX300 ComXpert Overview . . . . .	1-2
	1.2 Principles of Operation . . . . .	1-2
	1.3 Features and Capabilities . . . . .	1-3
	1.4 Controls and Connectors . . . . .	1-5
<b>Chapter 2</b>	<b>Getting Started: Setup and Operation . . . . .</b>	<b>2-1</b>
	2.1 Upon Receipt . . . . .	2-2
	2.2 Powering the Test Set . . . . .	2-4
	2.3 Verify Test Set Operation . . . . .	2-7
	2.4 CX300 Control and Operation . . . . .	2-7
	2.5 CX300 ComXpert Screens . . . . .	2-8
	2.6 UI Navigation, Control and Layout . . . . .	2-10
	2.7 Screen Layout . . . . .	2-11
	2.8 Operating and Navigating the User Interface . . . . .	2-15
<b>Chapter 3</b>	<b>System Settings Screens . . . . .</b>	<b>3-1</b>
	3.1 System Settings Screens . . . . .	3-2
<b>Chapter 4</b>	<b>Configuring System Settings . . . . .</b>	<b>4-1</b>
	4.1 Configure Battery Saving Mode . . . . .	4-2
	4.2 Test Set Display Settings . . . . .	4-2
	4.3 Setting Date and Time . . . . .	4-4
	4.4 Establishing a Network Connection . . . . .	4-5
	4.5 Setting up GNSS . . . . .	4-12
	4.6 Configuring Timing Reference (Clock Source) . . . . .	4-14
	4.7 Remotely Operating the Test Set . . . . .	4-15

---

	4.8	Setting up a Bluetooth® Connection	4-15
	4.9	Using Smart Access Anywhere	4-16
	4.10	Managing System Information	4-22
	4.11	Managing Options	4-23
	4.12	Updating the System Software	4-24
	4.13	Synchronizing to the StrataSync™ Server	4-28
	4.14	Re-imaging the System	4-29
	4.15	Capturing a Screen Shot	4-30
<b>Chapter 5</b>		<b>Test and Measurement Functions</b>	<b>5-1</b>
	5.1	Test Modes and Measurements	5-2
	5.2	Overview of Test and Measurement Screens	5-3
	5.3	Accessing Test Controls and Settings	5-14
	5.4	CX300 Generators	5-15
	5.5	CX300 Receive Functions	5-21
	5.6	CX300 Meters	5-27
	5.7	Audio Controls and Signal Routing	5-42
	5.8	DVM (Digital Voltmeter)	5-43
	5.9	Tone Decoding	5-44
	5.10	Tone Encoding	5-45
	5.11	Normalize	5-51
	5.12	Frequency List	5-52
	5.13	Channel Analyzer	5-53
	5.14	Oscilloscope	5-58
	5.15	Spectrum Analyzer	5-60
	5.16	AutoTest Mode	5-71
	5.17	Navigation Diagrams	5-75
<b>Chapter 6</b>		<b>Performing Tests and Measurements</b>	<b>6-1</b>
	6.1	RF Connection Configurations	6-2
	6.2	CX300 Self Test Procedure	6-4
	6.3	FM Transmitter Testing	6-6
	6.4	AM Transmitter Testing	6-11
	6.5	FM Receiver Performance Tests	6-15
	6.6	Channel Power Measurements	6-19
<b>Chapter 7</b>		<b>Managing Files and Reports</b>	<b>7-1</b>
	7.1	Managing Files	7-2
	7.2	File Manager Controls	7-5
<b>Chapter 8</b>		<b>Care, Maintenance, and Troubleshooting</b>	<b>8-1</b>
	8.1	Storing the Device	8-2
	8.2	Shipping Instructions	8-2



---

- 8.3 Operator Level Maintenance ..... 8-4
- 8.4 Charging the Battery ..... 8-5
- 8.5 Battery Replacement ..... 8-6
- 8.6 Resetting the ComXpert Base ..... 8-9
- 8.7 Updating Software ..... 8-9
- 8.8 CX300 ComXpert Self Test Procedure ..... 8-10
- 8.9 Troubleshooting Information ..... 8-10
  
- Appendix A CX300 ComXpert Specifications ..... A-1**
  - A.1 Power Specifications ..... A-2
  - A.2 Environmental Specifications ..... A-4
  - A.3 Weights, Dimensions, and Fans ..... A-5
  - A.4 Compliance and Safety Standards ..... A-5
  
- Appendix B Glossary ..... B-1**

This page intentionally left blank.



# List of Tables

Table	Title	Page
Table 1-1	CX300 Top Panel Controls and Connectors	1-6
Table 1-2	Power Button/LED - Status	1-9
Table 1-3	CX300 Side Panel Controls and Connectors	1-10
Table 2-1	CX300 ComXpert Standard Accessories	2-3
Table 2-2	Recommended Optional Accessories	2-4
Table 2-3	Device Toolbar Controls and Indicators	2-12
Table 2-4	Status Bar Indicators	2-15
Table 2-5	Numeric Keypad Controls and Settings	2-17
Table 2-6	Numeric Slider Controls	2-19
Table 2-7	UI Keyboard Controls	2-20
Table 3-1	File Manager Controls	3-2
Table 3-2	File Browser Functions	3-3
Table 3-3	Bluetooth Controls and Settings	3-4
Table 3-4	LAN IPv4 Controls and Settings	3-6
Table 3-5	LAN IPv6 Controls and Settings	3-7
Table 3-6	WiFi Controls and Settings	3-8
Table 3-7	Power Management Controls, Settings, and Indicators	3-10
Table 3-8	Power Indicator Status	3-11
Table 3-9	Date and Time Controls and Settings	3-13
Table 3-10	Display Controls and Settings	3-14
Table 3-11	Remote Controls and Settings	3-16
Table 3-12	Upgrade Screen Controls and Settings	3-18
Table 3-13	Clock Source Selections	3-20
Table 3-14	GNSS Lock Status	3-21
Table 3-15	GNSS Controls and Settings	3-22

---

Table 3-16 . . . .	System Information . . . . .	3-24
Table 3-17 . . . .	System Info Screen Controls and Settings . . . . .	3-24
Table 3-18 . . . .	Option Status Indicators . . . . .	3-25
Table 3-19 . . . .	Web Browser Controls. . . . .	3-26
Table 5-1 . . . . .	Test Home Screen Layout Description . . . . .	5-4
Table 5-2 . . . . .	Test Screen Layout Descriptions. . . . .	5-6
Table 5-3 . . . . .	CX300 Test Function Controls. . . . .	5-7
Table 5-4 . . . . .	Marker Toolbar Controls and Settings. . . . .	5-10
Table 5-5 . . . . .	Marker Reading Pane Data Fields . . . . .	5-12
Table 5-6 . . . . .	Test Controls and Settings. . . . .	5-14
Table 5-7 . . . . .	RF Generator Controls and Settings. . . . .	5-15
Table 5-8 . . . . .	Analog Modulation Controls and Settings. . . . .	5-17
Table 5-9 . . . . .	AF Generator Controls and Settings. . . . .	5-19
Table 5-10 . . . . .	RF Receiver Controls and Settings. . . . .	5-22
Table 5-11 . . . . .	Audio In Controls and Settings . . . . .	5-25
Table 5-12 . . . . .	UI Limit Indicators . . . . .	5-28
Table 5-13 . . . . .	Analog Demodulation Controls and Settings. . . . .	5-33
Table 5-14 . . . . .	RF Power Meter Controls and Settings. . . . .	5-35
Table 5-15 . . . . .	Demod SINAD Meter Controls and Settings . . . . .	5-36
Table 5-16 . . . . .	Demod Distortion Meter Controls and Settings . . . . .	5-37
Table 5-17 . . . . .	Demod SNR Meter Controls and Settings. . . . .	5-37
Table 5-18 . . . . .	Audio SINAD Meter Controls and Settings . . . . .	5-39
Table 5-19 . . . . .	Audio Distortion Meter Controls and Settings . . . . .	5-39
Table 5-20 . . . . .	Demod SNR Meter Controls and Settings. . . . .	5-40
Table 5-21 . . . . .	Audio Controls and Settings . . . . .	5-42
Table 5-22 . . . . .	Audio Signal Routing Controls and Settings . . . . .	5-42
Table 5-23 . . . . .	DVM Controls and Settings . . . . .	5-43
Table 5-24 . . . . .	Tone Decoding Controls and Settings. . . . .	5-44
Table 5-25 . . . . .	Tone Encoding Menus. . . . .	5-45
Table 5-26 . . . . .	Tone Encoding DTMF Controls and Settings . . . . .	5-46
Table 5-27 . . . . .	Tone Encoding DCS Controls and Settings. . . . .	5-47
Table 5-28 . . . . .	Tone Encoding CTCSS Controls and Settings . . . . .	5-48
Table 5-29 . . . . .	Tone Encoding Remote Controls and Settings . . . . .	5-48
Table 5-30 . . . . .	Tone Encoding Tone Sequential Controls and Settings. . . . .	5-49
Table 5-31 . . . . .	Tone Encoding Two Tone Sequential Controls and Settings. . . . .	5-49
Table 5-32 . . . . .	Normalize Controls and Settings. . . . .	5-51
Table 5-33 . . . . .	Frequency List Content . . . . .	5-52
Table 5-34 . . . . .	Channel Analyzer Controls and Settings. . . . .	5-53
Table 5-35 . . . . .	Oscilloscope Settings and Controls. . . . .	5-58

---

Table 5-36 . . . .	Spectrum Analyzer Frequency and Span Controls and Settings. . . . .	5-60
Table 5-37 . . . .	Spectrum Analyzer Amplitude/Scale Controls and Settings . . . . .	5-61
Table 5-38 . . . .	Spectrum Analyzer Bandwidth Controls and Settings . . . . .	5-63
Table 5-39 . . . .	Spectrum Analyzer Trace Controls and Settings. . . . .	5-65
Table 5-40 . . . .	Spectrum Analyzer Band Sweep and Trigger Controls and Settings . . . . .	5-68
Table 5-41 . . . .	Spectrum Analyzer Measurement Controls and Settings . . . . .	5-69
Table 5-42 . . . .	Spectrum Analyzer I/O Controls and Settings . . . . .	5-70
Table 5-43 . . . .	AutoTest - Save Profiles Controls and Settings. . . . .	5-71
Table 5-44 . . . .	AutoTest - Test Menu Controls and Settings . . . . .	5-72
Table 5-45 . . . .	AutoTest - Reports Tab Controls and Settings. . . . .	5-73
Table 6-1 . . . . .	FM Transmitter Tests - UUT Settings . . . . .	6-6
Table 6-2 . . . . .	AM Transmitter Tests - UUT Settings . . . . .	6-11
Table 6-3 . . . . .	FM Receiver Test - UUT Parameters. . . . .	6-15
Table 6-4 . . . . .	Spectrum Analyzer Channel Power - UUT Parameters. . . . .	6-19
Table 7-1 . . . . .	File Management Controls . . . . .	7-5
Table 8-1 . . . . .	Battery Replacement Part Number . . . . .	8-6
Table 8-2 . . . . .	Troubleshooting Guide . . . . .	8-11
Table A-1 . . . . .	Electrical Specifications. . . . .	A-2
Table A-2 . . . . .	Battery Specifications . . . . .	A-2
Table A-3 . . . . .	AC/DC Power Adapter. . . . .	A-3
Table A-4 . . . . .	Environmental Specifications . . . . .	A-4
Table A-5 . . . . .	CX300 ComXpert Weight and Dimensions . . . . .	A-5
Table A-6 . . . . .	Cooling Fans . . . . .	A-5
Table A-7 . . . . .	EMC Compliance Standards . . . . .	A-5
Table A-8 . . . . .	Safety Standards. . . . .	A-5





# List of Figures

Figure	Title	Page
Figure 1-1 . . . .	CX300 ComXpert Communications Service Monitor . . . . .	1-2
Figure 1-2 . . . .	CX300 Top Panel Controls and Connectors . . . . .	1-5
Figure 1-3 . . . .	CX300 Side Panel Controls and Connectors . . . . .	1-10
Figure 2-1 . . . .	System Home Screen . . . . .	2-8
Figure 2-2 . . . .	CX300 ComXpert Screen . . . . .	2-9
Figure 2-3 . . . .	CX300 Screen Layout . . . . .	2-10
Figure 2-4 . . . .	<b>CX300 ComXpert</b> Screen Layout . . . . .	2-12
Figure 2-5 . . . .	Numeric Keypad . . . . .	2-17
Figure 2-6 . . . .	Numeric Slider . . . . .	2-19
Figure 2-7 . . . .	Virtual “UI” Keyboard . . . . .	2-20
Figure 3-1 . . . .	Files Screen . . . . .	3-2
Figure 3-2 . . . .	Bluetooth Screen . . . . .	3-5
Figure 3-3 . . . .	Power Management Screen . . . . .	3-9
Figure 3-4 . . . .	Date and Time Settings - Manual Settings . . . . .	3-12
Figure 3-5 . . . .	Date and Time Settings - NTP Server . . . . .	3-12
Figure 3-6 . . . .	Display Settings . . . . .	3-14
Figure 3-7 . . . .	Remote Controls and Settings . . . . .	3-15
Figure 3-8 . . . .	Upgrade Screen . . . . .	3-17
Figure 4-1 . . . .	Wired Ethernet Connection Diagram . . . . .	4-17
Figure 4-2 . . . .	WiFi Connection Diagram . . . . .	4-17
Figure 4-3 . . . .	WiFi Smart-phone Connection Diagram . . . . .	4-18
Figure 4-4 . . . .	USB Smart-phone Connection Diagram . . . . .	4-18
Figure 5-1 . . . .	Test Home Screen - Layout Diagram . . . . .	5-3
Figure 5-2 . . . .	Example of Test and Measurement Main Screen . . . . .	5-5
Figure 5-3 . . . .	Marker Controls Toolbar . . . . .	5-9
Figure 5-4 . . . .	Marker Controls Toolbar . . . . .	5-12
Figure 5-5 . . . .	Limit Check Indicators - Example of Invalid State . . . . .	5-28

---

Figure 5-6 . . . .	Limit Check Indicators . . . . .	5-30
Figure 5-7 . . . .	Spectrum Analyzer Screen . . . . .	5-67
Figure 5-8 . . . .	Trace Legend Screen . . . . .	5-67
Figure 5-9 . . . .	Add Meter . . . . .	5-75
Figure 5-10 . . .	Expand button . . . . .	5-75
Figure 5-11 . . .	Full Test Settings button . . . . .	5-76
Figure 5-12 . . .	Marker Readings button . . . . .	5-76
Figure 5-13 . . .	Marker Controls button . . . . .	5-77
Figure 5-14 . . .	Marker View button and Marker Selection menu. . . . .	5-77
Figure 5-15 . . .	Meter pane . . . . .	5-78
Figure 5-16 . . .	Parameter Editor & Quick Access toolbar . . . . .	5-78
Figure 5-17 . . .	Select Meter-Graph type . . . . .	5-79
Figure 5-18 . . .	Test Function pane & Test Function Settings . . . . .	5-79
Figure 5-19 . . .	Test Home button . . . . .	5-80
Figure 5-20 . . .	Test Settings button. . . . .	5-80
Figure 6-1 . . . .	One Port Duplex Test Setup . . . . .	6-2
Figure 6-2 . . . .	RF Output/RF Input Two Port Duplex Test Setup . . . . .	6-2
Figure 6-3 . . . .	RF Output/RF Duplex Two Port Duplex Test Setup. . . . .	6-3
Figure 6-4 . . . .	RF Duplex/RF Input Two Port Duplex Test Setup . . . . .	6-3
Figure 6-5 . . . .	Self Test Screen (Example) . . . . .	6-5
Figure 6-6 . . . .	Digital Transmitter Test Setup Diagram . . . . .	6-7
Figure 6-7 . . . .	Digital Receiver Test Setup Diagram . . . . .	6-12
Figure 6-8 . . . .	Receiver Test Setup Diagram . . . . .	6-16
Figure 6-9 . . . .	Channel Power Measurements Setup Diagram . . . . .	6-20
Figure 8-1 . . . .	Battery Door Cover Thumbscrew . . . . .	8-7
Figure 8-2 . . . .	Battery Installation Diagram . . . . .	8-8





# Preface

This section explains how to use this manual. Topics discussed include the following:

- Content Overview ..... ii
- Purpose and Scope ..... iii
- Ordering information ..... iii
- Intended User ..... iii
- Typographical Conventions ..... iv
- Related Information ..... v
- Product Nomenclature ..... v
- Contact Information ..... v

# Content Overview

This manual is composed of the following chapters:

## **Chapter 1: Overview**

Provides an overview of the CX300 ComXpert's features and capabilities.

## **Chapter 2: Getting Started: Setup and Operation**

Provides instructions for installing, controlling and operating the CX300 ComXpert.

## **Chapter 3: System Settings Screens**

Provides an overview of System Functions.

## **Chapter 4: Configuring System Settings**

Describes setup procedures and settings for the CX300 ComXpert.

## **Chapter 5: Test and Measurement Functions**

Provides an overview of the Test and Measurement Functions.

## **Chapter 6: Performing Tests and Measurements**

Provides instructions for performing Test and Measurement procedures.

## **Chapter 7: Managing Files and Reports**

Provides instructions for managing Files and Reports.

## **Chapter 8: Care, Maintenance, and Troubleshooting**

Provides an overview of the Maintenance and Troubleshooting procedures.

## **Appendix A: Specifications**

CX300 ComXpert Specifications.

## **Appendix B: Glossary/Abbreviations**

Glossary and Abbreviations.

---

## Purpose and Scope

The purpose of this manual is to help users successfully use the CX300 ComXpert features and capabilities. This manual includes task-based instructions that describe how to install, configure, and operate the CX300 ComXpert.

This manual provides instructions for unpacking, setting up, and operating the CX300.

This manual also contains instrument specifications, and contact information for VIAVI's Technical Assistance Center (TAC).

Optional software functions such as P25 are documented in option-specific manuals. Refer to the CX300 website for available publications.

## Ordering information

This manual is a product of the VIAVI Technical Publications Department, issued for use with the CX300 ComXpert Communications Service Monitor. The PDF format of this manual is available on the VIAVI product website.

- The part number associated with this publication is 22130634.
- Type CX300 to find the manuals associated with the CX300 ComXpert.

Go to: <https://www.viavisolutions.com/en-us/resources/literature-library>

## Intended User

This manual is intended for personnel who are familiar with radio test systems and associated equipment and terminology. This manual is intended for users who want to use the CX300 effectively and efficiently.

Read this manual carefully before setting up or operating the instrument.

## Typographical Conventions

This manual uses the following typographical conventions:

**Table 1 Typographical Conventions**

Item(s)	Example(s)
References to terms used to identify key areas of the UI such as screens, panes, menus, or toolbars.	Navigate to the <b>Date and Time</b> screen. Open the <b>RF Receiver Settings Menu</b> . Some controls are also accessed from the <b>Quick Access Toolbar</b> .
Hardware buttons, keys, or switches that you press or flip.	Press the <b>On</b> button. Flip the <b>Power</b> switch to the on position.
Software components such as buttons, menus, tabs, or fields on a PC-based or Web-based user interface	Click <b>Start</b> . Click <b>File &gt; Properties</b> . Type the name of the probe in the <b>Probe Name</b> field.
Directory names, file names, and code and output messages that appear in a command line interface or a UI.	<code>\$NANGT_DATA_DIR/results</code> (directory) – <code>test_product/user/defaultUser.xml</code> (file name) – <code>All results okay.</code> (output message)
Text users must type exactly as shown.	– Restart the applications using the following command: <code>\$BASEDIR/startup/npui_init restart</code> Type: <code>a:\set.exe</code> in the dialog box.
References to other publications	Refer to <i>Newton's Telecom Dictionary</i> .

---

## Related Information

Viavi maintains a webpage where additional product information is available to customers:

- <https://www.viavisolutions.com/CX300>

Use this manual in conjunction with the following publications:

- Product Brochure: provides ordering information for parts and accessories
- Data Sheet: provides technical specifications
- Quick Start Guide, #22130635
- P25 Option Guide, #22146777
- DMR Option Guide, #22163052
- VNA Option Guide, #22163053
- Tetra Option Guide, #22166297
- Remote Programming Manual, #22146776
- Maintenance Manual, #22130636

Refer to the CX300 ComXpert product Web page for this and other product publications:

- <https://www.viavisolutions.com/en-us/product-category/radio-test/communications-service-monitors>

## Product Nomenclature

The terms CX300, CX300 ComXpert and test set are used to refer to the CX300 ComXpert Communications Service Monitor.

## Contact Information

Contact the Technical Assistance Center (TAC) for technical support or with any questions regarding this or other VIAVI products.

- Phone: 1-844-GO-VIAVI
- email: [Techsupport.Avcomm@viavisolutions.com](mailto:Techsupport.Avcomm@viavisolutions.com)

For the latest TAC information, go to:

- <https://www.viavisolutions.com/en-us/support/technical-product-support/technical-assistance>

This page intentionally left blank.

# CX300 ComXpert Overview

This chapter provides a general description of the CX300 ComXpert. Topics discussed in this chapter include the following:

- CX300 ComXpert Overview . . . . . 1-2
- Principles of Operation . . . . . 1-2
  - ComXpert Base Overview . . . . . 1-2
  - RF Application Module . . . . . 1-3
  - Software . . . . . 1-3
- Features and Capabilities . . . . . 1-3
  - ComXpert Platform and System Functions . . . . . 1-3
  - RF Features and Capabilities . . . . . 1-4
- Controls and Connectors . . . . . 1-5
  - Top Panel Controls and Connectors . . . . . 1-5
  - Side Panel Controls and Connectors . . . . . 1-10

## 1.1 CX300 ComXpert Overview

The CX300 ComXpert is a portable communications test set for use in the Land Mobile Radio, Private Mobile Radio, or Two-Way Communications Industry. The CX300 is capable of performing high power measurements as well as fault finding for antennas, power amplifiers, and interconnects.

The CX300 may be used for bench testing in the General Communications environment or in a field test environment. The CX300 is ideal for performing preventative maintenance on two-way radios and their applicable support infrastructure. When used in a bench-top environment, the CX300 can be powered by an external AC Power Supply. The CX300 can also be powered by dual, internal, rechargeable batteries for field test operation.



Figure 1-1 CX300 ComXpert Communications Service Monitor

## 1.2 Principles of Operation

The CX300 consists of the VIAVI ComXpert base which supports system functionality and the RF Application Module which supports CX300 RF test and measurement functions.

### 1.2.1 ComXpert Base Overview

The ComXpert base is a modular communications test and measurement instrument designed for indoor and outdoor test environments. The ComXpert base unit contains a processor, backplane interface, capacitive touchscreen and rechargeable batteries. The base processor is responsible for managing system level functions such as network connectivity, file management, and software upgrade procedures. The base processor is also responsible for managing the test set's power consumption/power saving functions and battery charging processes.



The touchscreen display provides the user interface (UI) for local test set control and operation. The platform's Ethernet and WiFi functions support remote operation using an external viewing application or via remote programming commands. There are two USB connectors for the use of an external USB memory to extend storage capacity or to upgrade the instrument's software. The USB ports can also be used for the "Auto-Test" application control of the radio under test. Reserved tether point for future development of the ComXpert base provides access to the test set's USB and Ethernet connectors, as well as the AC/DC Input connectors. The backplane provides the interface between the ComXpert base unit and CX300 RF Application Module.

## 1.2.2 RF Application Module

The CX300's RF Application Module supports the test set's RF test and measurement functions and instruments. The RF Application Module's mechanical housing contains the test set's RF and audio input/output connectors. The RF Application Module contains PCB assemblies that are responsible for processing and routing signals through the test set.

## 1.2.3 Software

CX300 software is a field-upgradeable software which can be updated using a network connection or a USB device. CX300 software also supports field-installed software options. The CX300 ComXpert ships from the factory with the current version of Software (SW) and Firmware (FW) installed on the test set. The **System Information screen** displays the version of the software and firmware installed on the test set. It is advisable to verify the software is current when it arrives, even when new. See [section 3.1.15](#), for System Information.

Routine maintenance checks should be performed to ensure the test set has been upgraded to the latest production software release. Refer to the CX300 product website, or contact VIAVI to check availability of the most current software version.

Software updates are performed from the **System Upgrade screen**. See "[Upgrade Screen](#)" for software update options. StrataSync™ provides an alternative method of updating the test set's software and firmware.

See "[Synchronizing to the StrataSync™ Server](#)" for the upgrade procedures.

## 1.3 Features and Capabilities

### 1.3.1 ComXpert Platform and System Functions

The ComXpert platform has the following hardware and system features:

- Two rechargeable batteries supports ~2.5 hours based on HW testing
- User-selectable automatic power shutdown and battery saving mode

- Capacitive Touchscreen Display with user adjustable back-light brightness and user configured screen saver
- Field upgradeable software and optional installation
- One Ethernet and two USB 2.0 connectors
- WiFi receiver for network connectivity
- GPS receiver for use as a timing reference

## 1.3.2 RF Features and Capabilities

The CX300 RF Module provides test and measurement capabilities that can be used to evaluate the transmit and receive performance of a radio system (radio, antenna, base station) and locate faults in antennas, power amplifiers, and cables.

The following are standard CX300 ComXpert features and functions. Modes of operation include Communications Test, Spectrum Analyzer, and Auto-Test. Refer to the CX300 ComXpert data sheet for a complete list of available options.

- Radio, Receive, Transmit, and Auto-Test modes of operation
- RF Instrument analyzers and meters
  - RF Spectrum Analyzer, supports up to 6 GHz (optional) with 20 MHz instantaneous bandwidth
  - VSWR, Distance to Fault, and Return Loss measurements
  - Audio Analyzer
  - Analog Modulation meters
  - Frequency Counter and RF Error meters
  - RF Power meter
  - Distortion, SINAD, and Signal-to-Noise (SNR) meters
  - AM/FM/PM modulation and demodulation
  - AM USB and AM LSB as supported modulation types
  - Measurement limit checks, user selectable measurement types (maximum, minimum, live, and average) for all meters
- Three internal AF Function Generators
- Test executive for automated test applications
- Self-Test and diagnostics for internal validation and testing
- Remote access and operation using Virtual Network Computing (VNC) viewing application or remote command interface (RCI)
- Dedicated one high power RF output port used as an output
- Dedicated high sensitivity, low RF input port and low RF output port

## 1.4 Controls and Connectors

This section describes the CX300's controls and connectors. See product specifications for complete performance specifications and input/output ratings.



### CAUTION

Do not overload input connectors. Refer to product specifications or the product data sheet for maximum input ratings.

### 1.4.1 Top Panel Controls and Connectors

The following CX300 test set identifies the top panel controls and connectors. Refer to Table 1-1 for functions and capabilities.

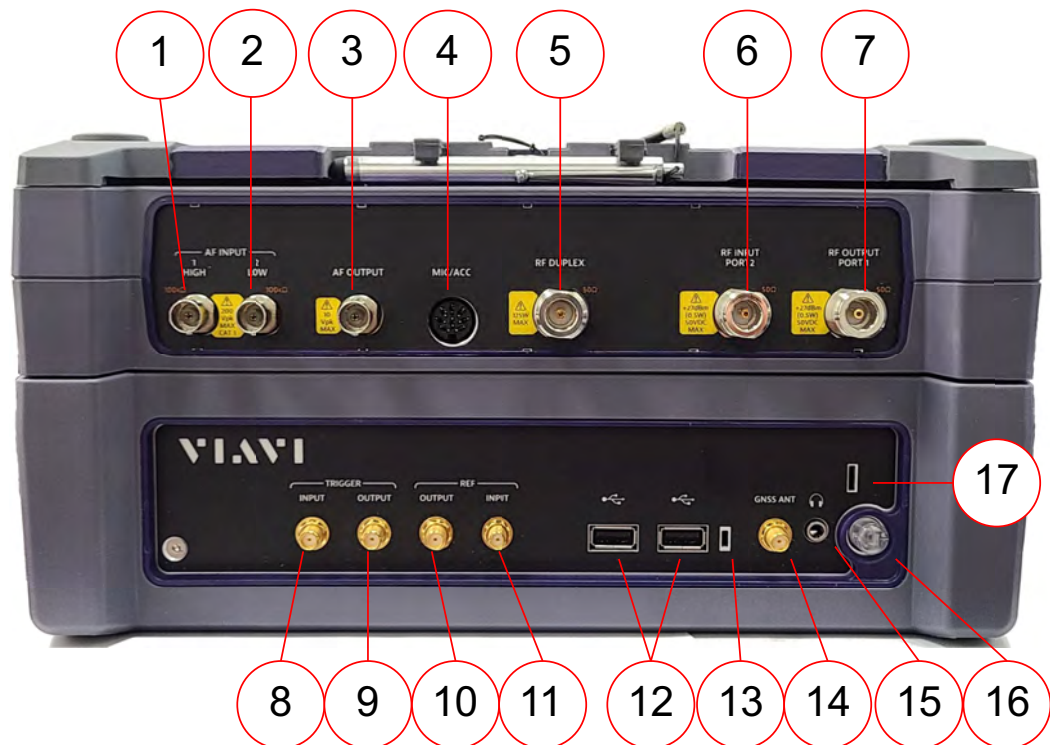

Figure 1-2 CX300 Top Panel Controls and Connectors

**Table 1-1 CX300 Top Panel Controls and Connectors**

<b>Idx #</b>	<b>Connector</b>	<b>Description</b>
1	<b>AF Input 1 High Connector</b>	The <b>AF Input 1 High</b> connector is a high audio input differential power connector used for receiving high power signals.
2	<b>AF Input 2 Low Connector</b>	The <b>AF Input 2 Low</b> connector is a low audio input differential power connector used for receiving low power signals and for performing high sensitivity measurements.
3	<b>AF Output Connector</b>	The <b>AF Output</b> connector is the audio output for the Audio Frequency Generators.
4	<b>MIC/ACC Connector</b>	The <b>MIC/ACC</b> connector is used to connect an external audio device such as a microphone.
5	<b>RF Duplex Connector</b>	The <b>RF Duplex</b> connector provides low level output and high level input detection.
6	<b>RF Input / Port 2</b>	The <b>RF Input</b> connector separates VNA measurements and is a dedicated RF Input connector. The <b>RF Input</b> connector is used for measuring low power RF signals when high sensitivity and/or Over-the-Air (OTA) testing is being performed. <b>Port 2</b> selection is reserved for future development.
7	<b>RF Output / Port 1</b>	The <b>RF Output</b> connector separates VNA measurements and is a dedicated RF output connector. The <b>RF Output</b> connector provides the maximum <b>RF output Level</b> of the RF Generator. <b>Port 1</b> selection is reserved for future development.
8	<b>Trigger Input Connector</b>	SMA-type female connector; receives 1 PPS clock or 10 ms synchronization signals from an external timing reference. Digital CMOS Input DC Coupled.



**NOTE**

Input signal requirements: Minimum logic high 2.4V, Maximum logic high 3.3 V.

Table 1-1 CX300 Top Panel Controls and Connectors (Continued)

Idx #	Connector	Description
9	<b>Trigger Output Connector</b>	The <b>Trigger Output</b> connector is an SMA type-F connector that sends 1 PPS clock or 10 ms synchronization signals from an internal timing reference. Digital Output DC Coupled 5V logic.
	<b>NOTE</b>	
		Do not terminate with 50 Ohm. Minimum termination value is 220 Ohm.
10	<b>REF Output Connector</b>	The <b>REF Output</b> connector provides a 10 MHz sine-wave reference signal at approximately 0 dBm into 50-Ohms.
11	<b>REF Input Connector</b>	The <b>REF Input</b> connector is an SMA type female connector that supports incoming 10 MHz, 13 MHz, or 15 MHz reference clock signals from an external frequency source. Input is AC-coupled 50 Ohm terminated. The test set's timing reference is configured on the <b>Clock Source screen</b> . See <a href="#">“Configuring Timing Reference (Clock Source)”</a> for instructions.
12	<b>USB Connectors</b>	<b>USB Connectors</b> with attached rubber covers supporting most USB memory devices with 32-bit file system. The USB connectors allow for the use of an external USB memory to extend storage capacity or to upgrade the instrument's software.
13	<b>Tether Point</b>	<b>Tether Point</b> with attached rubber cover for supporting the USB ports cover.
14	<b>GNSS Antenna</b>	The Global Navigation Satellite System ( <b>GNSS</b> ) <b>Antenna</b> connector is an SMA-type female connector that is used to connect a GNSS antenna which is used to acquire timing data. GNSS connection is configured on the <b>Clock source Screen</b> . See <a href="#">“GPS Timing Reference”</a> for instructions.

**Table 1-1 CX300 Top Panel Controls and Connectors (Continued)**

<b>Idx #</b>	<b>Connector</b>	<b>Description</b>
15	<b>Audio Connector</b>	The <b>Audio</b> connector is a 3.5 mm size mono jack that supports the use of headphones; connecting a headset that contains an integrated microphone turns off the CX300 internal speaker.
16	<b>Power Button/LED</b>	The <b>Power Button/LED</b> is used to turn the test set on and off. When the CX300 is connected to an AC power supply, the <b>Power Button/LED</b> indicates battery charging status. See <a href="#">Table 1-2 on page 1-9</a> for a description of LED color-coded status.
17	<b>Tether Point</b>	<b>Tether Point</b> with attached rubber cover for supporting the <b>Audio</b> connector cover.

### 1.4.1.1 POWER BUTTON/LED

The **Power Button/LED** use different colors to indicate the test set's operational status, battery, and AC Power usage.

**Table 1-2 Power Button/LED - Status**

LED Color	Indicates
<b>Not Illuminated</b>	<ul style="list-style-type: none"> <li>• Unit is OFF</li> <li>• Battery is not charging</li> </ul>
<b>Green</b>	<ul style="list-style-type: none"> <li>• Connected to AC Power</li> <li>• Unit is ON</li> <li>• Battery is fully charged (not charging)</li> </ul>
<b>Amber</b>	<ul style="list-style-type: none"> <li>• Connected to AC Power</li> <li>• Unit is On or Off</li> <li>• Battery is charging</li> </ul>
<b>Red</b>	<ul style="list-style-type: none"> <li>• NOT connected to AC Power</li> <li>• Battery is low</li> </ul>

## 1.4.2 Side Panel Controls and Connectors

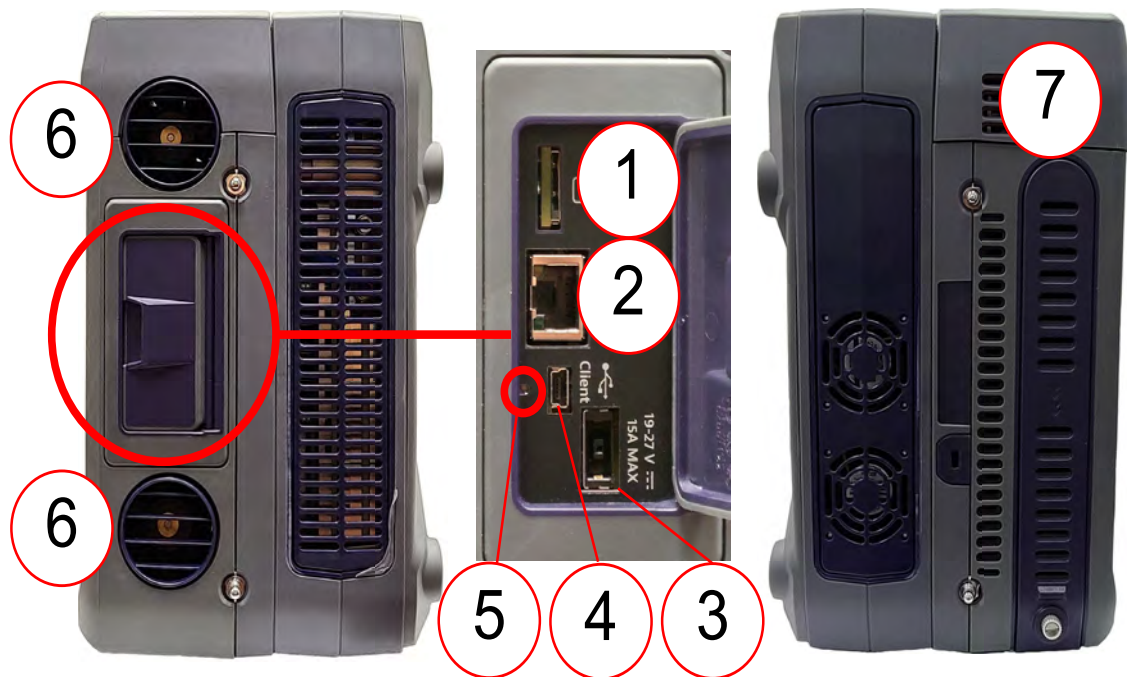



Figure 1-3 CX300 Side Panel Controls and Connectors

Table 1-3 CX300 Side Panel Controls and Connectors

Idx#	Connector /Controls	Description
1	<b>Micro SD Port</b>	The <b>Micro SD Port</b> allows a Micro SD card to be used as storage location for instrument data.
2	<b>LAN Connector</b>	The LAN connector is an RJ-45 Ethernet Connector that is used to connect the CX300 to a network connection for actions such as updating software and remote operation.
3	<b>AC/DC Power Adapter Connector</b>	The <b>AC/DC Power Adapter</b> connector is used to connect the test set to an AC Power Supply. See <a href="#">“AC Power Adapter/Cord” on page 12</a> for important safety information.
4	<b>Mini USB Connector</b>	The <b>Mini USB</b> connector supports USB Test and Measurement Class (TMC) and controls via SCPI communication.



Table 1-3 CX300 Side Panel Controls and Connectors (Continued)

Idx#	Connector /Controls	Description
5	<b>Reset Button</b>	The <b>Reset</b> button is a recessed button that is used to restore the device to known IP settings. See <a href="#">“Resetting the ComXpert Base”</a> for information and instructions.
 <b>CAUTION</b> DO NOT block air flow to these vents (see <a href="#">“Ventilation Requirements”</a> on <a href="#">page 16</a> for important safety information).		
6	<b>Cooling Fan Vent</b>	The fan vents allow air flow to the test set’s internal cooling fans.
7	<b>Battery Door Cover</b>	The Battery Door Cover protects the test set’s rechargeable battery. This cover should be kept closed except when replacing the battery.

This page intentionally left blank.

# Getting Started: Setup and Operation

This chapter describes how to install and operate the CX300 ComXpert. The topics discussed in this chapter are as follows:

- Upon Receipt . . . . . 2-2
  - Unpacking Equipment . . . . . 2-2
  - Inspect the Equipment . . . . . 2-2
  - Battery Inspection . . . . . 2-3
  - Verifying Shipment Contents . . . . . 2-3
  - Preparing for First Use . . . . . 2-4
- Powering the Test Set . . . . . 2-4
  - AC Power Operation . . . . . 2-5
  - Battery Operation . . . . . 2-5
  - Turning the Test Set On . . . . . 2-6
  - Turning Off or Rebooting the Test Set . . . . . 2-6
  - Forced Shutdown . . . . . 2-7
- Verify Test Set Operation . . . . . 2-7
- CX300 Control and Operation . . . . . 2-7
- CX300 ComXpert Screens . . . . . 2-8
- UI Navigation, Control and Layout . . . . . 2-10
  - Screen Layout . . . . . 2-10
- Screen Layout . . . . . 2-11
  - Device Toolbar . . . . . 2-12
  - Main Display Area . . . . . 2-14
  - Device Status Bar . . . . . 2-15
- Operating and Navigating the User Interface . . . . . 2-15
  - Selecting System and Test Screens . . . . . 2-15
  - Selecting and Entering Parameters . . . . . 2-16

## 2.1 Upon Receipt

This section describes tasks that should be completed when a CX300 ComXpert is received from the factory.

### 2.1.1 Unpacking Equipment

VIAVI instruments are shipped using anti-static packing material to stabilize the components inside the shipping container. Use care not to damage the shipping container and packaging materials when unpacking the test set. Materials should be stored for possible future use.

1. Cut and remove sealing tape on top of shipping container.
2. Open shipping container. Remove the top foam insert.
3. Remove the test set and accessories (when applicable) from the shipping container.
4. Remove anti-static packaging material from test set.
5. Unpack the two batteries.
6. Remove packaging material from the two batteries.
7. Store packing material and shipping container for possible future use.



#### NOTE

See [section 8.2, "Shipping Instructions"](#), on page 8-2 for information and instructions for shipping the equipment.

### 2.1.2 Inspect the Equipment

After unpacking the components, inspect the items for any possible damage that may have occurred during shipment. Report any damages to VIAVI.

- No signs of physical damage, including dents or scratches.
- LCD protector – no signs of damage, including scratches or cracks.
- Indicators (for example, LEDs) – no chips or cracks.
- Ports – should firmly hold attached cable plugs in place.
- Cables – no nicks or signs of fraying.
- Cable plugs – should not be loose or damaged.

## 2.1.3 Battery Inspection

Inspect the batteries for the following:

- Batteries show no physical signs of damage.
- Batteries show no signs of leakage.

## 2.1.4 Verifying Shipment Contents

Verify the shipment is complete according to the items listed on the packing list. Accessories may be shipped in a separate box. Report any discrepancies to VIAVI.

### 2.1.4.1 Standard Hardware Accessories

The following items are included with the CX300 ComXpert:

**Table 2-1 CX300 ComXpert Standard Accessories**

Part Number	Description	Qty
22141482	CX300 ComXpert	1
22142972	AC Power Adapter/Cord	1
27478	AC Power Cord - US / Canada	1
91803	AC Power Cord - China	1
27480	AC Power Cord - Continental Europe	1
27477	AC Power Cord - UK	1
22116266	Internal Batteries, 98 Watt-Hour, Lithium-Ion	2
22136776	Front Cover	1
22152084	Desktop Stand	1
22141588	Shoulder Strap, Black	1
22142165	Side Strap, Black	2
22132331	Stylus Pen	1
20327	Adapter;50 Ohm; N Plug to BNC Jack; Straight	3
22130635	CX300 ComXpert Quick Start Guide	1

### 2.1.4.2 Recommended Optional Accessories

The following are optional accessories that VIAVI recommends purchasing for the CX300 ComXpert. Refer to the product data sheet for a complete list of available optional accessories.

**Table 2-2 Recommended Optional Accessories**

Part Number	Description
22137295	Carrying Case, Hard Transit
22124979	Carrying Case, Soft
63351	RF Coaxial Cable
114475	Antenna Kit



**NOTE**

Optional accessories may be included as standard accessories with some system configurations. See the packing list for shipment contents.

### 2.1.5 Preparing for First Use

Perform the following when the test set is received from the factory:

- Remove the protective film from the test set’s front panel display.
- Install the batteries. [See section 8.5, “Battery Replacement”, on page 8-6](#) for the batteries installation procedure.

## 2.2 Powering the Test Set

The CX300 can be powered by two internal batteries, or by a grounded AC power supply.

## 2.2.1 AC Power Operation

The CX300 can be powered externally using an AC power supply. When the CX300 is connected to an AC power supply, and the batteries are installed in the test set, the test set automatically charges the batteries.



### CAUTION

- Only use the AC Power Adapter/Cord supplied with the instrument.
- Do not use the AC Power Adapter/Cord outdoors or in a wet or damp location.
- Only connect the AC Power Adapter/Cord to the correct mains voltage indicated on the ratings label.
- Do not use the AC Power Adapter/Cord if it appears damaged or modified.

### *To Connect to an AC Power Supply*

1. Connect the AC Power Adapter/Cord to the test set's DC Input Connector.
2. Connect the power cord connector to a grounded AC power supply.

## 2.2.2 Battery Operation

The CX300 is designed to be powered by two internal batteries or an external AC power supply. The internal batteries support up to 2.5 hours of continuous operation. After 2.5 hours of continuous operation the batteries will need recharging.

The amount of battery operation time remaining is indicated on the Battery Indicator located in the Device Toolbar and on the **Power Management screen**. The CX300 supports a time-out feature which conserves battery power; this feature is referred to as the battery saving mode. The time-out period is defined on the **Power Management screen**. See [section 3.1.5, "Power Management Screen", on page 3-9](#).



### WARNING

Improper grounding of equipment can result in electrical shock. To ensure proper grounding, this device should only be connected to a grounded AC Power Supply.

### *To Install the Battery*

See [section 8.5, "Battery Replacement", on page 8-6](#) for the battery installation procedure.

### **To Charge the Battery**

1. Connect the test set to an AC power supply. See [“AC Power Operation”](#).
2. Verify the test set Power button LED flashes amber to indicate the batteries are charging.
3. The **Power button** LED turns on and stays green when the batteries are fully charged.

## **2.2.3 Turning the Test Set On**

The CX300 is powered on and off using the **Power button** located on the top panel.

### **To Turn ON the Test Set**

1. Press and hold the **Power button** for approximately 1 second, then release.
2. Verify the **Power button LED** illuminates. The **Power button LED** color indicates battery status. See ["POWER BUTTON/LED" on page 1-9](#) for detailed information).
3. An initializing indicator screen is displayed during the boot-up process.



#### **NOTE**

An initializing indicator screen is displayed during the boot process which can take ~ 5-6 minutes.

4. The last viewed screen is displayed when the test set is ready for use.

## **2.2.4 Turning Off or Rebooting the Test Set**

***The following procedures describe how to turn off or reboot the test set when controlling it remotely:***

5. Navigate to **Home**.
6. Press CTRL + Q.
7. Select either **Power off** or **Reboot**, as desired.

***The following procedures describe how to Turn OFF the Test Set:***

1. Press and hold the **Power** button for approximately 1 second, then release.
2. When prompted, select **Power off** from the **Power Options screen** to power down the test set.
3. Wait while the test set performs a series of reboot processes. Do not interrupt the power-down process or unsaved information may be lost.



**The following procedure describes how to REBOOT the Test Set:**

1. Press and hold the **Power button** for approximately 1 second, then release.
2. When prompted, select **Reboot** from the **Power Options screen** to reboot the test set.
3. Wait while the test set performs a series of automated processes. Do not interrupt the **Reboot** process or unsaved information may be lost.

## 2.2.5 Forced Shutdown

To initiate a forced shutdown, press and hold the **Power button** for approximately 7 seconds to reboot process the unit.



### NOTE

This method should not be used when routinely powering down the test set. When a forced shutdown is performed, unsaved information will be lost.

## 2.3 Verify Test Set Operation

The CX300 ComXpert has an automated Built-in-Test (BIT) procedure. The BIT is referred to as a Self Test. The CX300's Self Test evaluates the general functionality of the test set's generate and receive function, instruments and switches to ensure the device is operating properly.

See [section 6.2, "CX300 Self Test Procedure"](#), on page 6-4 for instructions to run the CX300 self test.

## 2.4 CX300 Control and Operation



### NOTE

The following procedure is used to verify that the CX300 is operating properly. This procedure is not intended to verify that the CX300 is operating to specified performance parameters.

The CX300 can be controlled locally or remotely.

- Local Control and Operation
  - When controlled locally, the CX300 is controlled and operated using the touchscreen display or an external mouse and keyboard.
- Remote Control and Operation
  - When the CX300 is connected to a network, the test set can be controlled remotely using a viewing application or remote programming commands.
  - [See section 4.7, "Remotely Operating the Test Set"](#), on page 4-15 for instructions for configure the test set for remote operation.

## 2.5 CX300 ComXpert Screens

The **Home button** and **CX300 ComXpert button** are used to switch between system screens and test and measurement screens.

System screens contain controls and settings for system functions like network connectivity, system upgrades, timing reference, and power management, etc.

### Accessing System Screens

System screens are accessed using the following method:

1. Press the **Home button** on the **Device Toolbar**.
2. Press the **System button** on the left sidebar.
3. Select a system setting button from the **System Home screen**. Selecting a button from the **System Home screen** displays a screen that contains controls and settings for the selected function.



#### NOTE

Some system functions display a button in the **Device Toolbar** when the function is active. The button can be used to access function's screen.

When a system settings screen is active, selecting the **Home button** displays the **System Home screen**.

When a test and measurement screen is active, selecting the **Home button** displays the last viewed System screen.

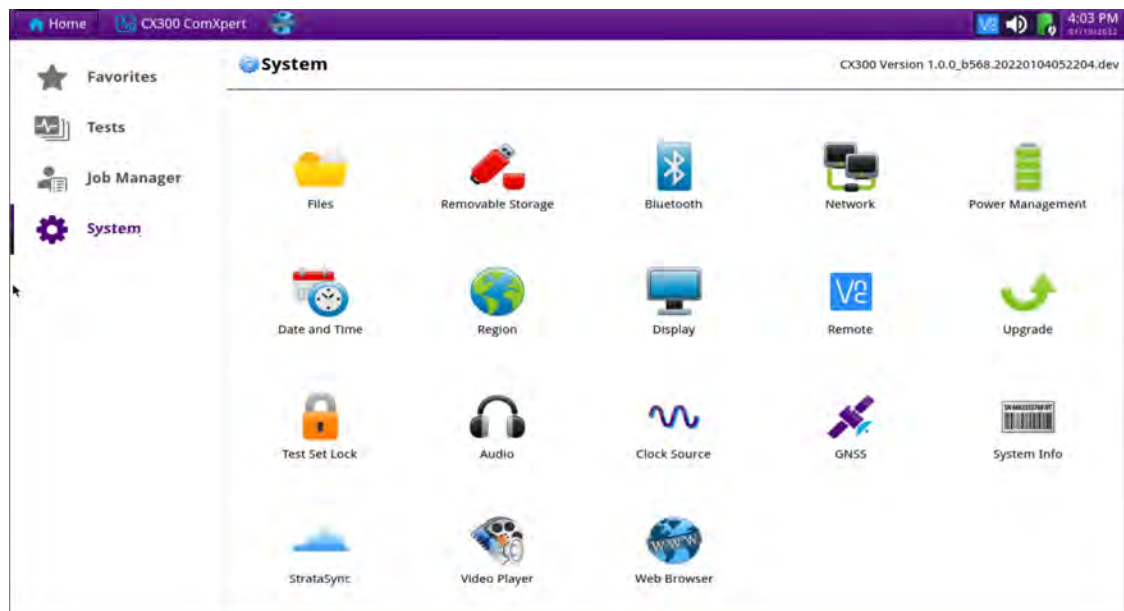

Figure 2-1 System Home Screen

Selecting the **CX300 ComXpert** button displays the last viewed test and measurement screen, or mode measure screen.

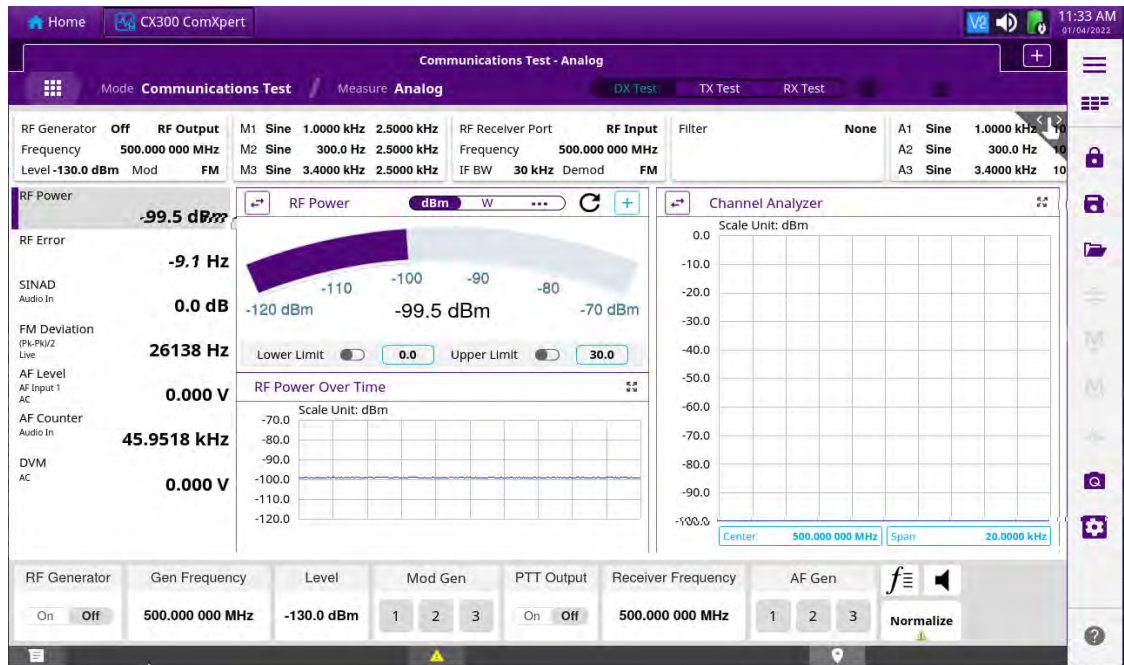

Figure 2-2 CX300 ComXpert Screen

The **CX300 ComXpert** screen contains controls and settings for system functions like Radio Test, Spectrum Analyzer, Measurements and AutoTest.

### Accessing CX300 ComXpert Screen

The **CX300 ComXpert** screen is accessible using the following method:

- Press the **CX300 ComXpert** button on the **Device Toolbar**.



Select a control from the **CX300 ComXpert** screen for desired Test and Measurement Screens, or Mode Measurement Screens. The **CX300 ComXpert** screen contains the controls and settings for the desired Test and Measurement Screens, for performing Test and Measurements. See [Figure 2-2](#) and [Figure 2-4](#).

## 2.6 UI Navigation, Control and Layout

This section describes the CX300 User Interface (UI) layout and how to navigate between system and test applications and functions. The CX300 UI is designed to be intuitive and easy to use. The Liquid Crystal Display (LCD) is a capacitive touchscreen that operates similarly to a mobile device. The touchscreen supports gestures such as press to open/select/activate, etc.

### 2.6.1 Screen Layout

CX300 screen layout and content changes based on factors such as the selected function, user settings and modes of operation. All screens consist of several main areas: a header bar with soft keys, a main display area, a Device Status Bar, a test settings toolbar, a quick access toolbar with controls, and a Test Controls Toolbar on the right side of the screen.

For detailed test screen layout and descriptions, see “[Test Screen Layout](#)”.

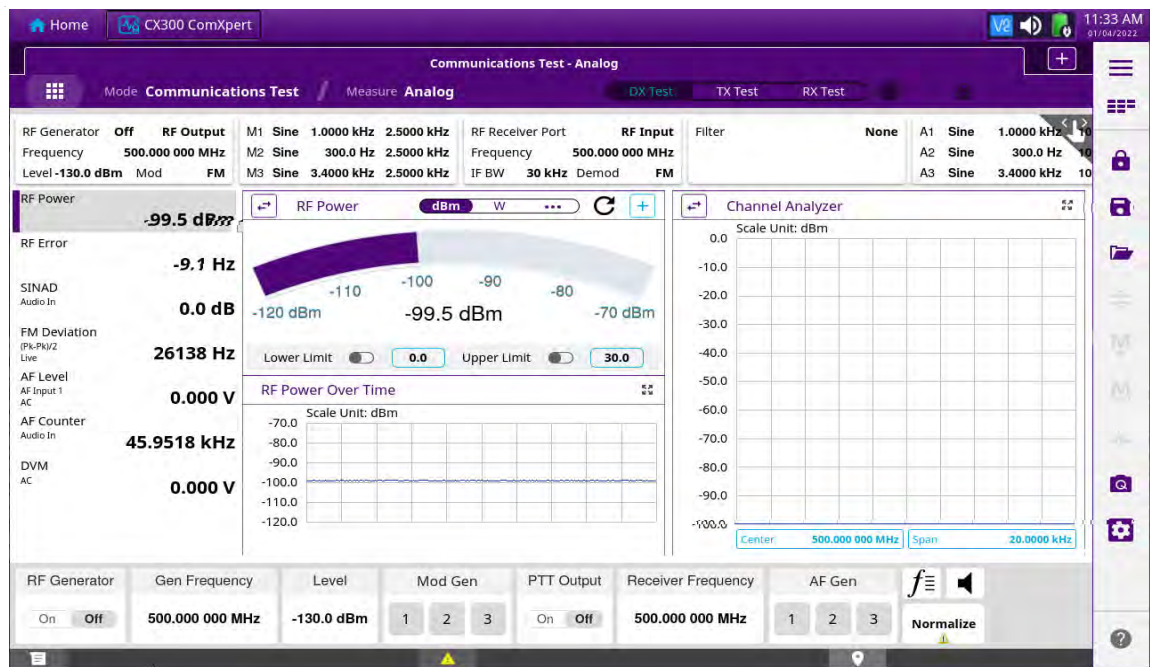

Figure 2-3 CX300 Screen Layout

#### 2.6.1.1 Home Screen

When the CX300 is powered on the **Home screen** is displayed. See [Figure 2-3](#). The **Home screen** contains collapsible menus that expand to provide access to the system and test functions that are available on the device.

When the device is received from the factory, the **Home screen** lists the standard and optional functions that are available on the device. The content displayed on the Home Screen can be changed from the **Home Screen Settings panel**.

The **Home screen** footer area can be used to create short cuts to commonly used functions and applications.

### 2.6.1.2 Test and System Settings Screens

CX300 test screens contain controls, settings and other UI components applicable to the selected test function. The content of the test screens depends on the selected mode of operation as well as the active test and measurement function. See [Figure 2-3](#) for an example.

See [Chapter 4 “Configuring System Settings”](#) for information about Configuring System Settings.

See [Chapter 5 “Test and Measurement Functions”](#) for information about Test and Measurement Screens.

## 2.7 Screen Layout

This section provides a general overview of CX300 screen layout. See [Chapter 5 “Test and Measurement Functions”](#) for a detailed description of test and measurement screens and [Chapter 3 “System Settings Screens”](#) for a description of system screens.

The user will encounter a variety of different screen layouts when using the CX300. The layout and contents of the main display area change according to factors such as the selected mode of operation and how the user configures the User Interface (UI). The general framework of the UI consists of the following areas:

- Device Toolbar ([page 2-12](#))
- Main Display Area ([page 2-14](#))
- Status Bar ([page 2-15](#))

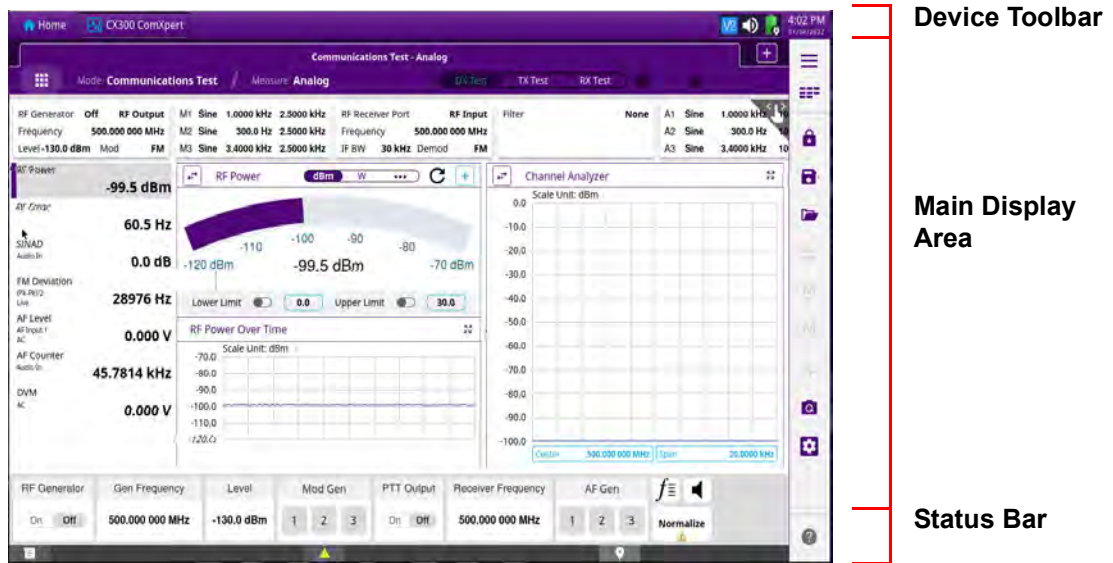

Figure 2-4 CX300 ComXpert Screen Layout

### 2.7.1 Device Toolbar

The Device Toolbar contains controls that are used to access CX300 system, test, and measurement screens. Some of the controls are also used to indicate test set status and active functions.

The Device Toolbar is located at the top of the UI. This toolbar is visible on all screens. The following controls are located in the toolbar.

Table 2-3 Device Toolbar Controls and Indicators











Button	Name	Description
	<b>Home (System) Button</b>	The <b>Home (System) button</b> accesses system configuration functions. When this button is pressed, the UI updates to the last viewed system screen. When a system screen is open, pressing the <b>Home (System) button</b> displays the <b>System Home screen</b> . See <a href="#">section 3.1 System Screens</a> for detailed descriptions of system functions.

Table 2-3 Device Toolbar Controls and Indicators (Continued)

Button	Name	Description
	<b>CX300 ComXpert Button</b>	The <b>CX300 ComXpert button</b> accesses CX300 test and measurement functions. When this button is pressed, the UI updates to the last viewed test and measurement screen, or mode measurement screen.
	<b>Web Browser Button</b>	The <b>Web Browser button</b> is displayed on the <b>Device Toolbar</b> when a web browser is open. Pressing the <b>Web Browser button</b> displays the web browser screen. <a href="#">See section 3.1.18, “Web Browser Screen”, on page 3-26</a> for detailed information about this function.
	<b>File Button</b>	The <b>File button</b> is displayed on the device toolbar when a file has been opened on the test set. If screen focus has changed, pressing this button opens the file on the display. <a href="#">See section 3.1.1, “Files “File Browser” Screen”, on page 3-2</a> for detailed information about this function.
	<b>Remote Button</b>	The <b>Remote button</b> is displayed when the test set is being accessed remotely and accesses controls and settings that are used to configure the CX300 for remote access. <a href="#">See section 3.1.9, “Remote Screen”, on page 3-15</a> for detailed information about this function. <a href="#">See section 4.7, “Remotely Operating the Test Set”, on page 4-15</a> for instructions to configure the test set for remote operation.
	<b>Clock Source Button</b>	The <b>Clock Source button</b> is displayed on the <b>Device Toolbar</b> when the test set’s timing source is set to something other than <b>Internal</b> . Press the <b>Clock Source button</b> to access controls for selecting the test set’s timing source. <a href="#">See section 3.1.13, “Clock Source Screen”, on page 3-19</a> for detailed information about this function. <a href="#">See section 4.6, “Configuring Timing Reference (Clock Source)”, on page 4-14</a> for instructions to configure the test set’s clock source.

**Table 2-3 Device Toolbar Controls and Indicators (Continued)**

Button	Name	Description
	<b>GNSS Button</b>	<p>The <b>GNSS button</b> is displayed on the <b>Device Toolbar</b> when GNSS is enabled on the test set. Pressing the <b>GNSS button</b> accesses GNSS controls and settings.</p> <p>See section 3.1.14, “GNSS Screen”, on page 3-20 for detailed information about this function. See section 4.5, “Setting up GNSS”, on page 4-12 for instructions to configure the test set for GNSS connection.</p>
	<b>WiFi Button</b>	<p>The <b>WiFi button</b> is displayed on the System Toolbar when WiFi functionality has been enabled on the <b>Network screen</b>.</p> <ul style="list-style-type: none"> <li>The indicator is red when WiFi is enabled, but a WiFi connection has not been established.</li> <li>The indicator is green when the CX300 has established a WiFi connection.</li> </ul> <p>See section 3.1.4.2, “WiFi Controls and Settings”, on page 3-8 for detailed information about this function. See section 4.9.3.2, “WiFi Connection”, on page 4-17 for instructions to connect the CX300 to a WiFi network.</p>
	<b>Audio Button</b>	<p>The <b>Audio button</b> accesses CX300 audio controls. See section 3.1.12, “Audio Screen”, on page 3-19 for detailed information about this function.</p>
	<b>Power Indicator</b>	<p>The <b>Power Indicator button</b> accesses and displays information about the test set’s power usage configuration and the battery charge state. See section 3.1.5, “Power Management Screen”, on page 3-9 for more information.</p>

## 2.7.2 Main Display Area



- The contents of the main display area will be updated according to the selected system or test function. The layout and contents of this area are described in detail in the following sections:
- [Chapter 3 “System Settings Screens”](#), provides descriptions of all system functions and system screen controls and settings.
- [Chapter 5 “Test and Measurement Functions”](#), provides descriptions of standard CX300 test and measurement functions.



### 2.7.3 Device Status Bar

The device status bar contains indicators that provide visual status of test set functions. This status bar displays various status indicators as described below.

**Table 2-4 Status Bar Indicators**

Indicator	Name	Description
	<b>GPS Indicator</b>	This indicator is displayed even when the device has no GPS information.
	<b>Alert Indicator</b>	This indicator is visible even when there is no warning condition.
	<b>Message Indicator</b>	<p>When there are messages, this opens a Message Log of the user's actions; the log supports up to 10 messages.</p> <p>When a Message is opened from the Message Log, Messages are displayed in the <b>Message</b> window.</p> <p>If there are no messages, the Message Indicator does not open a message log.</p>

## 2.8 Operating and Navigating the User Interface

This section provides a general overview of the layout and behavior of the CX300 UI including how to:

- Access functions on the test set
- Operate the UI
- Select and edit data fields

The CX300 UI can be operated locally using the touch-based display or a USB mouse and keyboard. The CX300 can also be controlled remotely using a VNC viewing application or Remote Command Interface (RCI). See section 4.7, "Remotely Operating the Test Set", on page 4-15.

### 2.8.1 Selecting System and Test Screens

The **Home button** and **CX300 ComXpert button** are used to switch between system screens and test and measurement screens.



- These buttons are located on the left side of the Device Toolbar, at the top of the screen, see Figure 2-4.
- If not already on the **System Home screen**, press the **Home button** to go to the **System Home screen**, see Figure 3-1.

## 2.8.2 Selecting and Entering Parameters

Screen components such as tabs, menus, and buttons are selected by touching the component on the display, or by selecting the component with a mouse.

### 2.8.2.1 Toggle Buttons

Toggle buttons are used for settings that have two options such as, ON/OFF, or Enable/Disable. The Toggle buttons are color-coded to provide a visual indication of status.



**Selected:** Purple background with white text. In this example, On is selected.

**Non-selected:** White background with purple text. In this example, Off is not selected.

### 2.8.2.2 Menus and Menu Items

Menus are indicated by a menu indicator  , located on the parameter button.

To select a menu item, open the menu and select the item from the list. When a menu item is selected, the selection is activated.

### 2.8.2.3 Numeric Entry Controls

When a numeric field is selected, a numeric entry control window is displayed for defining the parameter. Users have two tools for editing numeric parameters, the

- Numeric Keypad ([Figure 2-5](#))
- or the Numeric Slider ([Figure 2-6](#))

The buttons located in the upper right corner of each keypad switch between the **Numeric Keypad** and the **Numeric Slider**.

- [See section 2.8.2.3.1, “Numeric Keypad”, on page 2-17](#) for a description of the controls and settings on the **Numeric Keypad**.
- [See section 2.8.2.3.2, “Numeric Slider”, on page 2-18](#) for a description of the controls on the **Numeric Slider**.

### 2.8.2.3.1 Numeric Keypad

The **Numeric Keypad** allows the user to enter a value and to use the step buttons to increment or decrement the value in the defined **Step** field.

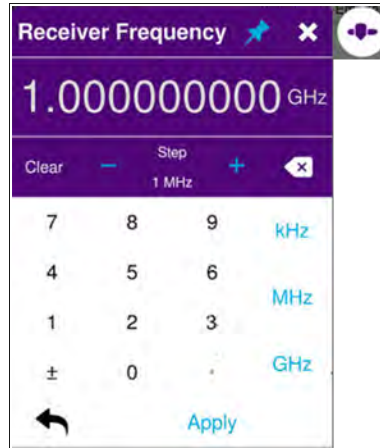













Figure 2-5 Numeric Keypad

The **Numeric Keypad** contains the following controls:

Table 2-5 Numeric Keypad Controls and Settings

Control	Name	Description
	<b>Pin Button</b>	When the <b>Pin button</b> is enabled (blue), the <b>Numeric Keypad</b> remains open after the <b>Apply</b> button is pressed. The <b>Pin button</b> also recalls the last location of the pop-up when closing/opening. De-selecting the <b>Pin button</b> will display the pop-up open in the center like normal.
	<b>Close Button</b>	This button closes the <b>Numeric Keypad</b> . Any changes that have not been applied will be lost when the <b>Close button</b> is pressed.
	<b>Clear Button</b>	This button clears the numerical value that is or has been entered.
	<b>Step Decrease</b>	Pressing this button decreases the parameter by the value in the <b>Step field</b> .
	<b>Step Increase</b>	Pressing this button increases the parameter by the value in the <b>Step field</b> .
	<b>Step Field</b>	The <b>Step field</b> defines the increment value by which a parameter is decreased or increased when the  and  buttons are pressed.

**Table 2-5 Numeric Keypad Controls and Settings (Continued)**

Control	Name	Description
	<b>Step Backspace</b>	The <b>Step Backspace button</b> undoes the last action.
	<b>Undo Button</b>	The <b>Undo button</b> terminates an edit that has not yet been applied.
	<b>Apply Button</b>	The <b>Apply button</b> confirms and enters the defined settings and closes the Numeric Keypad. Enable the <b>Pin button</b> (see " <a href="#">Pin Button</a> " on page 2-17) to keep the Numeric Keypad open after the <b>Apply button</b> is pressed.
	<b>Units Buttons</b>	Pressing a unit-of-measure button applies the parameter in the selected unit. The units of measure that are available on the keypad depends on the parameter. The user can also commit with the external keyboard. Example: pressing 'k' will commit the entered value as kHz, 'm' for MHz, etc.

**To Define Values using Numeric Keypad**

1. Use the number keys on the keypad to enter the desired value.
2. To enter the value using the current unit-of-measurement, press the **Apply button**.
3. To enter the value using a new unit-of-measurement, select the desired unit-of-measurement button. The new value is applied.

**2.8.2.3.2 Numeric Slider**

The **Numeric Slider** bar allows the user to select and change a defined range of values. The values to be changed are indicated by a bounding box (the light blue highlighted area). [Figure 2-6](#) shows the bounding box around the number '500.' The position of the bounding box adjusts the precision setting.

The **Left** and **Right Arrow buttons** are used to adjust the size of the bounding box, defining the last value selected in the bounding box.

Once the digit range is selected, the value is increased or decreased by dragging the **Slider Bar** or pressing the **Increment Up** and **Decrement Down** arrows. Values are active at the time that they are being changed.

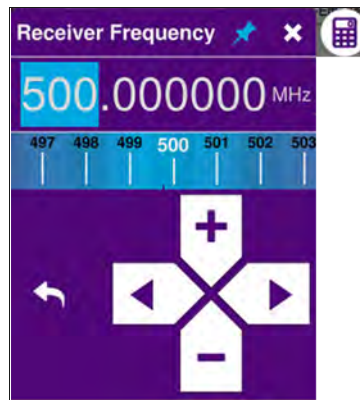









Figure 2-6 Numeric Slider

The **Numeric Slider** contains the following controls:

Table 2-6 Numeric Slider Controls

Control	Name	Description
	<b>Pin Button</b>	When the <b>Pin button</b> is enabled (blue), the <b>Numeric Slider</b> remains open after the <b>Apply</b> button is pressed.
	<b>Close Button</b>	The <b>Close button</b> closes the <b>Numeric Slider</b> . Any changes that have not been applied will be lost when the <b>Close button</b> is pressed.
<b>Slider Bar</b>		
		The <b>Slider Bar</b> is used to adjust the value inside the bounding box. The <b>Slider Bar</b> adjusts the value in large increments; use the <b>Increment Up/Decrement Down Arrow buttons</b> to adjust the value in smaller increments.
	<b>Cancel Button</b>	The <b>Cancel button</b> terminates an edit that has not yet been applied.
	<b>Left / Right Arrow Button</b>	Pressing the <b>Left Arrow</b> decreases the size of the bounding box, moving the right edge one place to the left each time the button is pressed.
		Pressing the <b>Right Arrow</b> increases the size of the bounding box, moving the right edge one place to the right each time the button is pressed.
	<b>Increment Up / Decrement Down Buttons</b>	The <b>Increment Up button</b> increases the last digit selected in the bounding box by one each time the button is pressed.
		The <b>Decrement Down button</b> decreases the last digit selected in the bounding box by one each time the button is pressed.

### To Define Values using Numeric Slider

1. Use the **Left and Right Arrow** buttons to adjust the right edge of the bounding box to define the last digit to be included in the digit range.
2. Once the digit range is defined, use the **Increment Up** or **Decrement Down buttons** or the **Slider Bar** to increase or decrease the value within the bounding box.
3. When the desired setting is reached, use the **Close button**  to close the **Numeric Slider** window.

### 2.8.2.4 Virtual UI Keyboard



The Virtual “UI” keyboard is displayed when a setting requires the user to enter alpha/numeric information such as a file name.



Figure 2-7 Virtual “UI” Keyboard

The **UI Keyboard** contains the following controls:

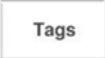
Table 2-7 UI Keyboard Controls

Control	Name	Description
	<b>Recent List Button</b>	The <b>Recent List button</b> displays a list of recent entries committed on the virtual keyboard.
	<b>Tags Button</b>	The <b>Tags button</b> is used to create frequently used keywords that are used in file names.
	<b>Close Keyboard Button</b>	The <b>Close Keyboard button</b> closes the UI keyboard. Any un-entered changes are lost when the keyboard is closed.

# System Settings Screens

This chapter provides a description of the CX300 system functions and the controls and settings located on each screen. This chapter contains the following content:

- System Settings Screens . . . . . 3-2
  - Files “File Browser” Screen . . . . . 3-2
  - Removable Storage Screen . . . . . 3-3
  - Bluetooth® Screen . . . . . 3-4
  - Network Screen . . . . . 3-5
  - Power Management Screen . . . . . 3-9
  - Date and Time Screen . . . . . 3-12
  - Region Screen . . . . . 3-14
  - Display Screen . . . . . 3-14
  - Remote Screen . . . . . 3-15
  - Upgrade Screen . . . . . 3-17
  - Test Set Lock Screen . . . . . 3-18
  - Audio Screen . . . . . 3-19
  - Clock Source Screen . . . . . 3-19
  - GNSS Screen . . . . . 3-20
  - System Info Screen . . . . . 3-23
  - StrataSync™ Screen . . . . . 3-25
  - Video Player Screen . . . . . 3-26
  - Web Browser Screen . . . . . 3-26



## NOTE

See [Chapter 4 “Configuring System Settings”](#) for step-by-step instructions to configure various system settings.

## 3.1 System Settings Screens

### 3.1.1 Files “File Browser” Screen

The **Files screen** is used to access and manage files that are stored in the test set’s hard drive. The File tool supports standard file functions such as copy and paste, delete, and rename.

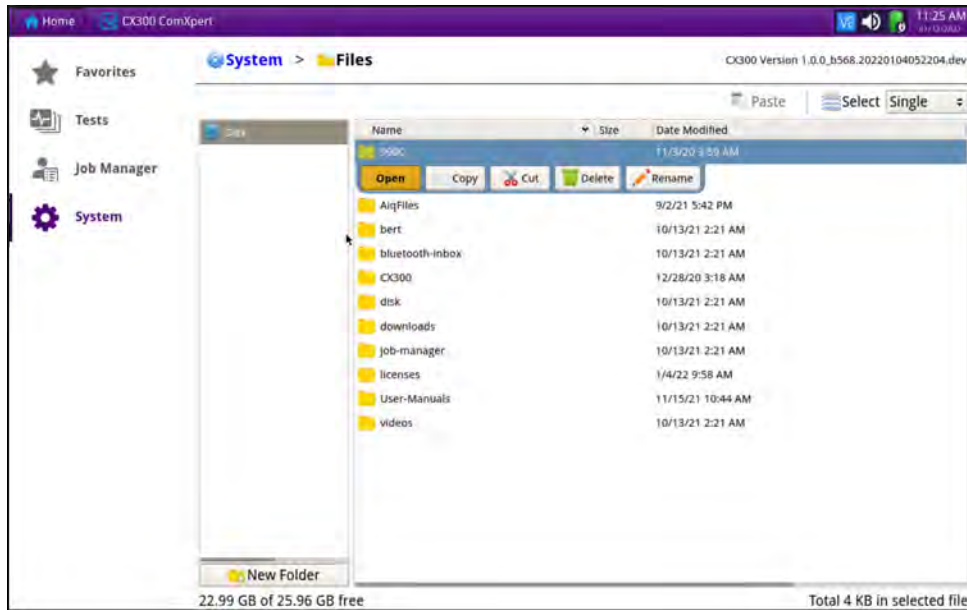
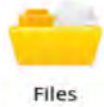

Figure 3-1 Files Screen

The following controls are located on the **Files screen**:

Table 3-1 File Manager Controls

Control	Description
 Files	Files Button
<b>New Folder Button</b>	This button is used to create a new folder. The new folder will be created inside of the currently selected directory. Directories and folders can be moved using the cut and paste, or copy and paste process.
<b>Paste Button</b>	This button is enabled when using the Copy function (see “Copy / Paste Button” description in <a href="#">Table 3-2 on page 3-3</a> ).
<b>Select Menu</b>	This menu is used to select and de-select files and directories.



The following controls are enabled when a file or folder is selected:

**Table 3-2 File Browser Functions**

<b>Open Button</b>	<p>This button displays the selected file. When a file has been opened, the <b>File button</b> is displayed in the <b>Device Toolbar</b> (see <a href="#">“Device Toolbar Controls and Indicators”</a> for a description).</p> <p>Only one file can be opened at any given time. When a file is open, opening another file closes the file that is already opened and displays the newly selected file.</p>
<b>Copy / Paste Button</b>	<p>The copy and paste function is intended to be used to copy and paste a file from one directory to another. Pasting a file in the same directory as the source file does not create a duplicate (copy) file, it overwrites the existing file.</p> <p>The <b>Paste button</b> is activated when Copy has been selected.</p>
<b>Cut</b>	<p>The cut function is used to move a file to a different location. When a file is pasted in a new location the file is deleted from it’s previous location.</p>
<b>Delete</b>	<p>This button deletes the selected file. A deleted file cannot be restored.</p>
<b>Rename</b>	<p>This button opens a dialog window that is used to rename a file.</p>

### 3.1.2 Removable Storage Screen

The **Removable Storage screen** accesses files which are located on external storage devices such as a USB device or SD card.

File storage location is defined as part of the file save procedure. See [section 7.1.1, “Saving Files”](#), on page 7-2 for more information.

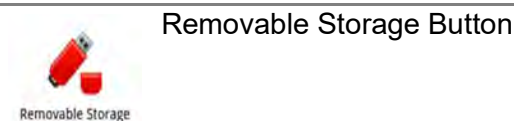

### 3.1.3 Bluetooth® Screen

The **Bluetooth screen** contains controls and settings that are used to configure the CX300 for Bluetooth connectivity. The CX300 can be configured to initiate pairing with other devices and to allow other devices to pair with the test set. See [Figure 3-2](#).

On the remote device, enter a pairing code if prompted, press the Pair button to pair the remote device with the CX300. See [section 3.1.4.3, “Network Certificates”, on page 3-8](#) for instructions for managing the test set’s digital certificates.

The **Bluetooth screen** contains the following controls and settings:

**Table 3-3 Bluetooth Controls and Settings**

Control/Setting	Description
	Bluetooth Button
<b>Enable Bluetooth</b>	Enables and disables the test set’s Bluetooth access. The CX300 is “visible” to other devices when this check box is selected.
<b>Allow other devices to pair with this device</b>	Determines whether or not the CX300 allows a device to pair with the test set.
<b>Device name</b>	Displays the name assigned to the CX300. This name can be changed using the <b>Device Name</b> field located on the <b>Remote screen</b> . See <a href="#">section 3.1.9, “Remote Screen”, on page 3-15</a> for more information.
<b>Start/Stop Scanning Button</b>	This button is enabled when Bluetooth is ON. Pressing the button initiates a search for all available Bluetooth enabled devices within range of the CX300. The <b>Start Scanning button</b> changes to the <b>Stop Scanning button</b> when a scan is in process. Pressing the <b>Stop Scanning button</b> halts the scan; any devices that were located during the search remain listed when the scan is stopped.
<b>Paired Devices</b>	This lists devices that have been paired with the CX300. Selecting a device from the list connects the CX300 to the device.
<b>Discovered Devices</b>	When a scan is performed, this area of the screen is populated with a list of Bluetooth enabled devices that are within range of the CX300.

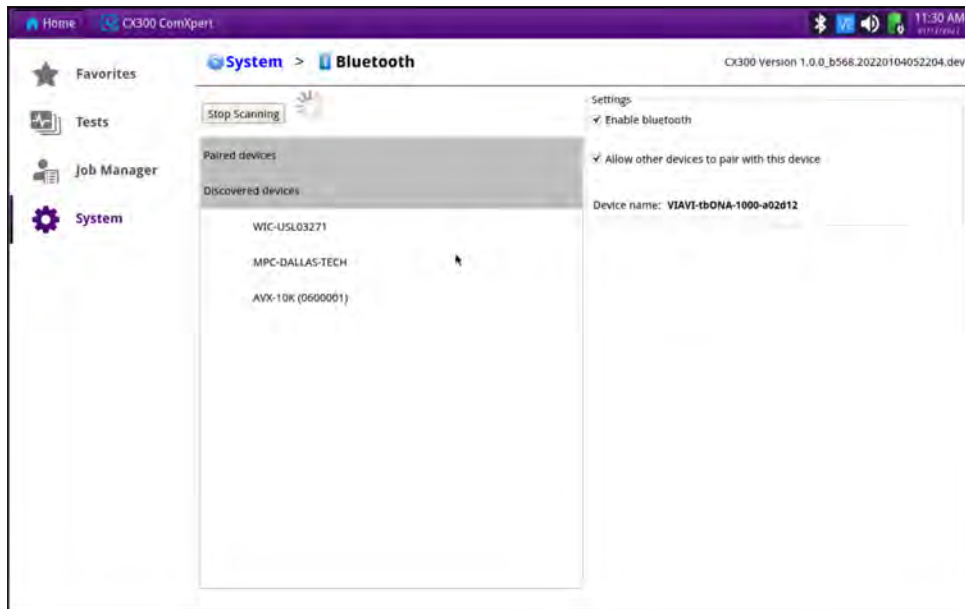

Figure 3-2 Bluetooth Screen

### 3.1.4 Network Screen

The controls and settings located on the **Network screen** are used to configure the test set for access via a wired Local Area Network (LAN) or WiFi network. Controls are also available for managing network certificates. Once network access is configured, the CX300 can be controlled remotely using a viewing application such as VNC viewer or the Smart Access Anywhere utility. See [section 3.1.9](#) for more information. The test set can also be controlled remotely using remote programming commands.



Network Button

Network

#### 3.1.4.1 LAN Controls and Settings

LAN controls and settings are displayed when the **LAN tab** is selected from the left side of the **Network screen**. The test set can be configured to obtain all IPv4 parameters from a DHCP (Dynamic Host Configuration Profile) server, or configured to use a user-defined Static IP Address. IPv6 is also supported.

See [section 4.7](#) for step-by-step instructions to connect the CX300 to a LAN or WiFi network.



**ALERT**

Users who are unfamiliar with the parameters on the **LAN tab** should seek technical assistance from their IT department. A network configuration error may cause problems for local network operation.

The following controls and settings are used to configure a wired network connection:

**Table 3-4 LAN IPv4 Controls and Settings**

<b>Control/Setting</b>	<b>Description</b>
<b>IP Mode</b>	Selects whether the device connects to the network using a DHCP or Static IP Address. <b>Dynamic Host Configuration Protocol (DHCP)</b> <ul style="list-style-type: none"><li>When <b>DHCP</b> is selected, the server of the network to which the device is connecting assigns the network up-link IP address, subnet mask, gateway, and DNS.</li></ul> <b>Static</b> <ul style="list-style-type: none"><li>When <b>Static</b> is used to manually define network IP connections.</li></ul>
<b>Static</b>	<b>IPv4 Address</b> <ul style="list-style-type: none"><li>Enter the device's IP address (which will be used when accessing the provider network).</li></ul> <b>IPv4 Subnet Mask</b> <ul style="list-style-type: none"><li>Enter the subnet mask address to indicate whether the packets are to be routed to other subnetworks.</li></ul> <b>IPv4 Gateway</b> <ul style="list-style-type: none"><li>Enter the address for the gateway that is used to route packets that are not on the same subnet.</li></ul> <b>IPv4 DNS Server</b> <ul style="list-style-type: none"><li>Enter the address of the DNS server.</li></ul>

**Table 3-5 LAN IPv6 Controls and Settings**

Control/Setting	Description
<b>Mode</b>	<p>Selects how the test set connects to the network when using IPv6 mode.</p> <p><b>Disabled</b></p> <ul style="list-style-type: none"> <li>Disables IPv6 connectivity.</li> </ul> <p><b>Auto</b></p> <ul style="list-style-type: none"> <li>When <b>Auto</b> is selected, the server of the network to which the device is connecting assigns the network setting.</li> </ul> <p><b>Manual</b></p> <ul style="list-style-type: none"> <li>When <b>Manual</b> is used, the network connections must be configured manually.</li> </ul>
<b>Manual</b>	<p><b>IPv6 Global Address</b></p> <ul style="list-style-type: none"> <li>Enter the device's IPv6 address to access the global network.</li> </ul> <p><b>(IPv6) Subnet Prefix Length</b></p> <ul style="list-style-type: none"> <li>Enter the subnet prefix length.</li> </ul> <p><b>(IPv6) Gateway</b></p> <ul style="list-style-type: none"> <li>Enter the address for the gateway that is used to route packets that are not on the same subnet.</li> </ul> <p><b>(IPv6) DNS Server</b></p> <ul style="list-style-type: none"> <li>Enter the address of the DNS server.</li> </ul>

***Virtual Local Area Network (VLAN)***

A VLAN is a group of devices on one or more networks that are configured to communicate as if they were connected to the same wire. VLANs are identified by an identifier (VLAN ID) which is a number between 0 and 4095.

When the **VLAN check box** is enabled, the CX300 can be connected to a VLAN. The **VLAN ID field** defines the VLAN ID assigned to the CX300.

### 3.1.4.2 WiFi Controls and Settings

The following controls and settings are used to establish a WiFi connection.

**Table 3-6 WiFi Controls and Settings**

Control/Setting	Description
<b>Enable Wireless Adapter</b>	This check box is used to enable the CX300's WiFi function. When WiFi is enabled, the test set initiates a network search for other devices on the wireless network.
<b>WiFi Address List</b>	This list shows all devices on the network that are within range of the test set. A lock icon next to a device indicates a secure network. When a secure network is selected, a settings window is displayed, to allow entering the information necessary to access the selected WiFi network.
<b>MAC Address</b>	This is the MAC (Media Access Control) Address of the CX300's Network Interface Card (NIC).
<b>Status</b>	This field indicates the CX300's WiFi connectivity status. <ul style="list-style-type: none"><li>• Disabled<ul style="list-style-type: none"><li>• WiFi connectivity is turned off.</li></ul></li><li>• Disconnected<ul style="list-style-type: none"><li>• WiFi connectivity is turned ON, but the test set is not connected to a WiFi network.</li></ul></li><li>• Connected<ul style="list-style-type: none"><li>• The test set is connected to a WiFi network.</li></ul></li></ul>

### 3.1.4.3 Network Certificates

Digital certificates certify the ownership of a public key by the named subject of the certificate. This allows others to rely upon the digital signature, to verify the owner of a server is trustworthy, and that the server is secure. Trusted certificates can be used to create secure connections to a server, without worry that by accessing the server a user will be exposing themselves to a malicious party on the server network.

The CX300's **Certificate tab** is used to manage the test set's digital certificates.

### 3.1.5 Power Management Screen

The **Power Management screen** displays information about the test set's battery (when installed in the test set) and indicates if the test set is connected to an AC Power Supply.

The fill-color of the battery graphic provides a visual indicator of charge status. The battery's charge level is displayed as a percentage below the battery graphic.

#### **Battery Power Saving Mode**

The test set is equipped with a battery power-saving mode that is enabled by selecting the **Enable auto-off while on battery** check box.

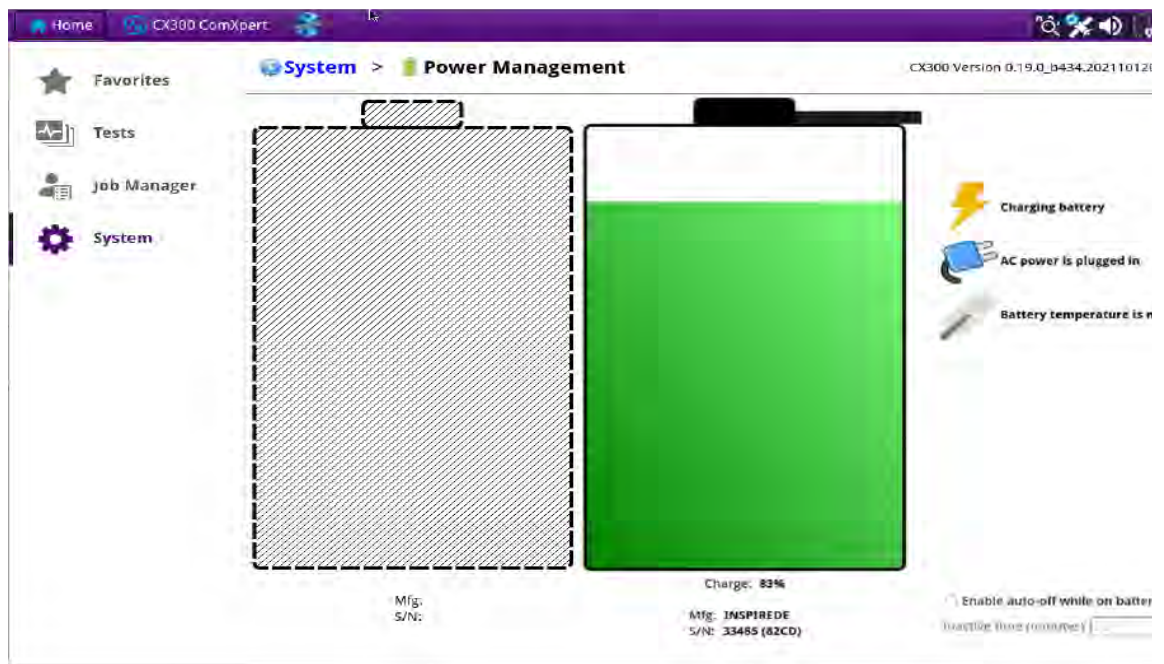
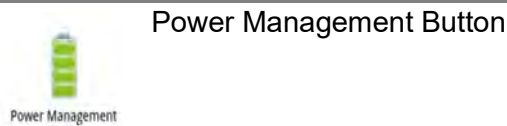









Figure 3-3 Power Management Screen



The following controls, settings, and indicators are located on the **Power Management screen**:

**Table 3-7 Power Management Controls, Settings, and Indicators**

Icon	Name	Description
	<b>Battery Not Detected Indicator</b>	Displays if no battery is installed.
	<b>Battery Reserve Indicator</b>	Displays the amount of time the device can be operated on the remaining battery charge, at current rate of power consumption. This indicator is not displayed when the test set is connected to an AC power supply.
	<b>Charging Indicator</b>	Appears when the battery is charging.
	<b>Not Charging Indicator</b>	Appears when the battery is not charging.
	<b>DC Power Source Indicator</b>	Displays whether the test set is being powered by external DC power.
	<b>AC Power Source Indicator</b>	Displays when the test set is being powered by the battery.
	<b>Battery Temperature</b>	Provides a visual indicator of the battery temperature. The test set is equipped with a safety feature to ensure the battery stops charging if the test set's thermal temperature exceeds 45°C. In the event the test set's temperature reaches 45°C, the battery ceases charging until temperature reaches or drops below 44°C.
Charge: 83%	<b>Battery Info</b>	Provides the user helpful info related to each battery, including Charge Level (%), the Manufacturer, and the Serial Number.
Mfg: INSPIREDE S/N:		



**Table 3-7 Power Management Controls, Settings, and Indicators (Continued)**

Icon	Name	Description
<input type="checkbox"/>	Enable auto-off while on battery	
	Inactive time (minutes) <input type="text" value="30"/>	
	<b>Enable auto-off while on battery</b>	Enables the battery power saving mode. When this check box is selected, the user can define the length of inactivity that can occur before the test set goes into hibernate mode.
	<b>Inactive Time</b>	Specifies the length of inactivity that can pass before the test set goes into power save mode.





**NOTE**

The **Power Indicator** is located on the Device Toolbar.

Table 3-8 identifies and describes the different states of the **Power Indicator** a user may encounter when using the test set:

**Table 3-8 Power Indicator Status**

	Indicates the following: <ul style="list-style-type: none"> <li>• Connected to an AC power supply (plug icon)</li> <li>• Battery is charging</li> </ul>
	Indicates the following: <ul style="list-style-type: none"> <li>• Not connected to an AC Power supply (no plug icon)</li> <li>• Running on battery power</li> <li>• Green fill level indicates battery charge remaining.</li> </ul>
	Indicates the following: <ul style="list-style-type: none"> <li>• No Battery installed (battery grayed out)</li> <li>• Connected to an AC Power supply (plug icon)</li> </ul>

### 3.1.6 Date and Time Screen

The settings on the **Date and Time screen** configure the CX300’s internal calendar and clock. Date and time can be set manually using the time and calendar controls and settings on the screen, or the CX300’s date and time can be synchronized with an FTP Server.

See section 4.3, “Setting Date and Time”, on page 4-4 for more information about setting the date and time.

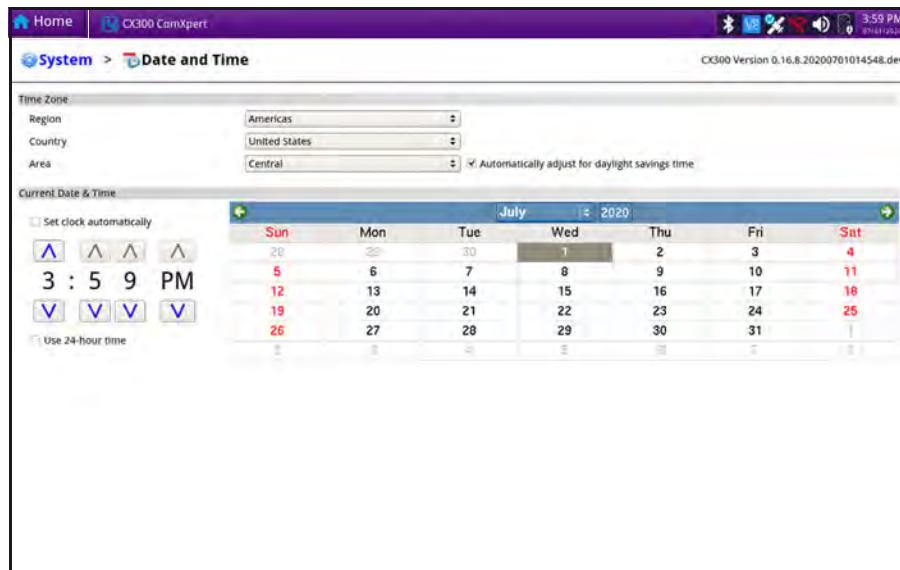

Figure 3-4 Date and Time Settings - Manual Settings

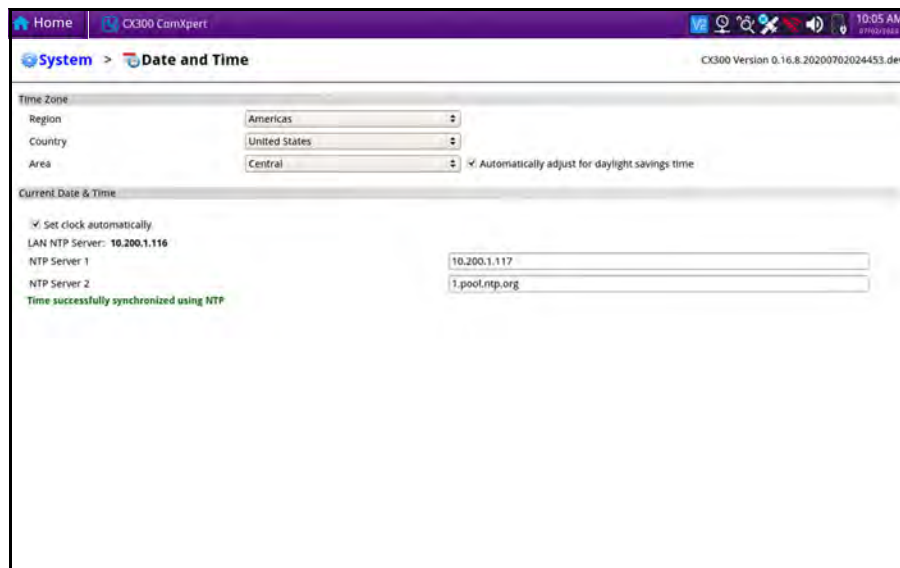



Figure 3-5 Date and Time Settings - NTP Server

The **Date and Time** screen contains the following controls and settings:

**Table 3-9 Date and Time Controls and Settings**

Control/Setting	Description
	Date and Time Button
<b>Time Zone</b>	
<b>Region</b>	Selects the continent in which the country is located.
<b>Country</b>	Selects the country to be used to define date and time settings.
<b>Area</b>	Selects the geographical areas located within the selected country (when applicable).
<b>Date and Time</b>	
<b>Set clock automatically</b>	This check box is used to synchronize the test set's date and time with the clock of an NTP server. When the test set has successfully synchronized with an NTP Server, the screen updates to show status. See <a href="#">section 4.3.6</a> for instructions.
<b>NTP Server "X"</b>	These fields are enabled when the <b>Set clock automatically</b> check box is selected. The fields are used to define the primary and secondary NTP Server that the test set uses to synchronize time and date settings.
<b>Clock Controls</b>	The clock controls are used to manually set the test set's clock. These controls are not active when the Set clock automatically check box is selected.
<b>Use 24-hour time</b>	When this check box is selected, time is displayed in 24 hour format hh:mm:ss. This setting is not available or active when the Set clock automatically check box is selected.
<b>Calendar Controls</b>	The calendar controls are used to manually set the test set's date. These controls are not active when the Set clock automatically check box is selected.

### 3.1.7 Region Screen

The settings on the **Region screen** are used to specify international settings for number and date formats used to display information on the user interface. See section 4.3.1, “To Set International Settings”, on page 4-4 as needed.

### 3.1.8 Display Screen

The controls and settings located on the **Display screen** allows users to customize the appearance of the display. Users can adjust the brightness of the touchscreen, enable the screen saver, and, when required, calibrate the touchscreen display.

See section 4.2, “Test Set Display Settings”, on page 4-2 as needed for procedures.

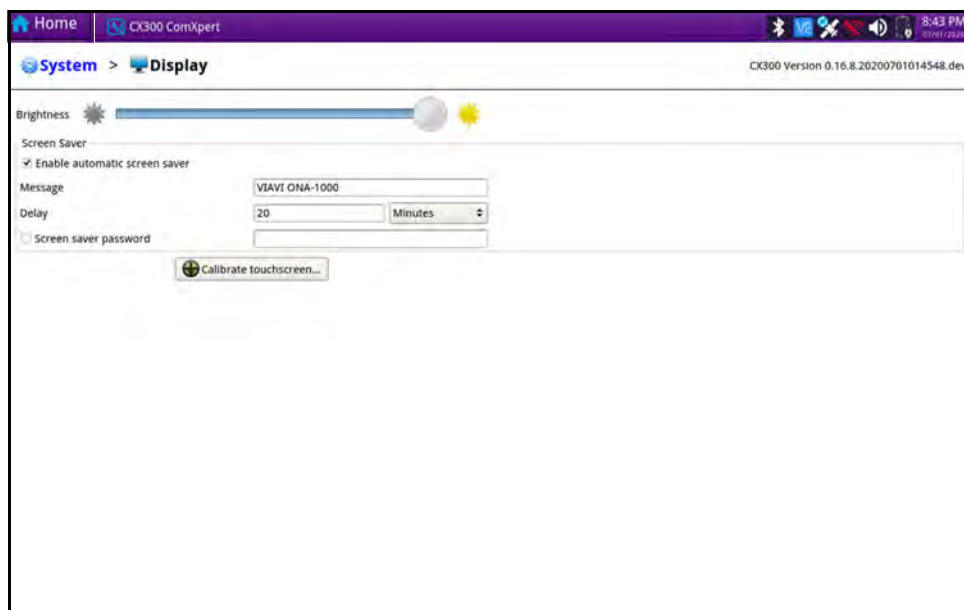

Figure 3-6 Display Settings

The **Display screen** contains the following controls and settings:

Table 3-10 Display Controls and Settings

Control/Setting	Description
	Display Button
<b>Brightness</b>	Adjusts the intensity of the display.

Table 3-10 Display Controls and Settings (Continued)

Control/Setting	Description
<b>Screen Saver</b>	The CX300 can be configured to display a screen saver which appears when the test set has been inactive for the length of time defined in the <b>Delay</b> field. See <a href="#">See section 4.2.4, “Configuring the Screen Saver”, on page 4-3.</a>
<b>Message Field</b>	The message field defines the information that is displayed on the screen saver.

### 3.1.9 Remote Screen

When the CX300 is connected to a network the test set can be controlled remotely using an external viewing application or remote programming commands. The **Remote screen** contains controls and settings that are used to configure the test set for access from a remote location. [See section 4.7, “Remotely Operating the Test Set”, on page 4-15](#) for instructions to connect to the test set to a network.



#### NOTE

The test set’s remote default settings are “OFF”; restoring the test set to factory default settings will terminate all remote connections. Remote connectivity cannot be re-established until the test set is reconfigured locally to enable remote access.

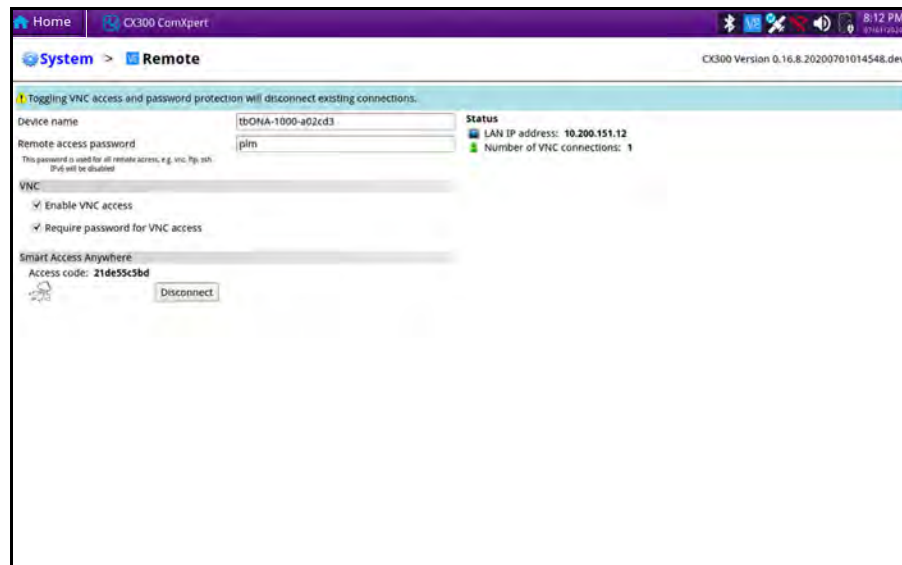



Figure 3-7 Remote Controls and Settings

The **Remote screen** contains the following controls and settings:

**Table 3-11 Remote Controls and Settings**

Control/Setting	Description
	Remote Button
<b>Device Name</b>	This field defines the name associated with the test set. The device name is associated with the name that is seen when using Bluetooth.
<b>Remote access password</b>	This field defines the password that is used when the <b>Require password for VNC access</b> check box is selected.
<b>VNC Settings</b>	
<b>Enable VNC Access</b>	This check box enables or disables remote access to the test set. When remote access is enabled, the <b>Remote button</b>  appears in the Device Toolbar.
<b>Require password for VNC access</b>	This check box selects if a password is required to remotely access the test set. The password is defined in the <b>Remote access password</b> field.
<b>Smart Access Anywhere</b>	Smart Access Anywhere allows users to view and control the CX300 user interface (UI) from a remote workstation. In addition to configuring the instrument and performing tests, you can transfer files to and from the CX300 using the File Manager. <a href="#">See section 4.9.6, “Transferring Files with Smart Access”, on page 4-21</a> for information.  <a href="#">See section 4.9, “Using Smart Access Anywhere”, on page 4-16</a> for detailed instructions for installing and using the Smart Access Anywhere utility.

### 3.1.10 Upgrade Screen



**NOTE**

On the Upgrade Screen, the **Start Over** button is not active until after you press either the **Network** button or **USB** button, and the Server Address file does not appear until you press the **Network** button.

The CX300 can be updated from files which have been placed on a USB device or from files located on a network server. The software upgrade procedure is an intuitive, guided procedure that can easily be performed in a field environment. The **Upgrade screen** contains controls that are used to update the test set’s software and firmware.

This section describes the top-level controls and prompts that users encounter when upgrading the CX300 located on the **Upgrade screen**, and are described as part of the software update. See section 4.12, “Updating the System Software”, on page 4-24 for information.

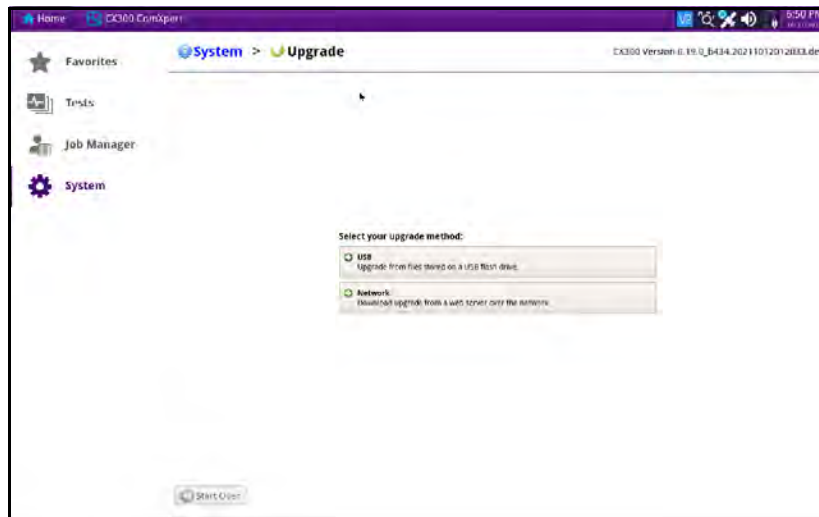



Figure 3-8 Upgrade Screen

The **Upgrade screen** contains the following controls and settings:

**Table 3-12 Upgrade Screen Controls and Settings**

Control	Description
	Upgrade Button
<b>USB Button</b>	<p>Performs a software update using files that were placed on a USB drive.</p> <p>An error message is displayed when this button is selected and a USB device is not connected to one of the CX300's USB connectors.</p>
<b>Network Button</b>	Updates the test set via a network connection to a server.
<b>Server Address</b>	<p>This field is displayed when the <b>Network button</b> is selected. The field defines the URL address of the server from where the software is being downloaded.</p> <p>The server firewall must be configured to allow the CX300 access to the server.</p>
<b>Start Over Button</b>	Returns to the <b>Upgrade Home screen</b> .

### 3.1.11 Test Set Lock Screen

The **Test Set Lock screen** contains controls and settings that allow the test set to be locked to prevent unauthorized access to the unit. When locked, a password is required to access the test set.

This function is useful when using the test set remotely to prevent local users from inadvertently interrupting a test.

	Test Set Lock Button
---	----------------------



### 3.1.12 Audio Screen

The controls and settings located on the **Audio screen** are used to manage speaker and microphone volume settings. When test and measurement screens are active, Audio controls are managed from the **Audio and Signal Routing** window. See section 5.7, “Audio Controls and Signal Routing”, on page 5-42 for more information.



Audio Button

Audio



**NOTE**

Connecting a headset that contains an integrated microphone into the CX300 Audio connector turns the CX300’s internal speaker off.

### 3.1.13 Clock Source Screen

The clock source setting selects the reference frequency and timing source that is used for performing system test and measurement functions. The controls and settings located on the **Clock Source screen** are used to configure the CX300 timing source. When the **Clock Source** is set to **Auto**, or an external reference is selected, the **Clock Source status button** on the **Device Toolbar** updates to display the clock source in use.

See section 4.6, “Configuring Timing Reference (Clock Source)”, on page 4-14 for instructions for configuring the test set’s timing source.



**NOTE**

When selecting an external clock source, ensure that the clock source is connected to the unit and the external clock source is accurate to within +/- 500 ppb.







Clock Source Button

Clock Source

The CX300 supports the following clock source selections.

**Table 3-13 Clock Source Selections**

<b>Internal</b>	
No Display	When <b>Internal</b> is selected, the CX300 uses the test set's 10 MHz internal clock as the timing source.
<b>External - 10 MHz</b>	
	When <b>External - 10 MHz</b> is selected, the CX300 uses an external 10 MHz frequency reference as the test set's timing source.
<b>External - 13 MHz</b>	
	When <b>External - 13 MHz</b> is selected, the CX300 uses an external 13 MHz frequency reference as the test set's timing source.
<b>External - 15 MHz</b>	
	When <b>External - 15 MHz</b> is selected, the CX300 uses an external 15 MHz frequency reference as the test set's timing source.
<b>GPS</b>	
	When <b>GPS</b> is selected, the CX300 uses a GPS signal as the test set's frequency and timing source. GPS connectivity must be configured before this selection can be used as a clock source.
<b>Auto Select</b>	
	When <b>Auto Select</b> is selected, the clock source is selected by the system. <ul style="list-style-type: none"><li>• No external source detected: the system uses the internal reference.</li><li>• External source detected: the system uses the external reference and auto-adjusts based on the frequency detected (i.e., 10, 13, or 15 MHz).</li></ul>

### 3.1.14 GNSS Screen

Global Navigation Satellite System (GNSS) refers to a constellation of satellites that transmit positioning and timing data to GNSS receivers; the GNSS receivers use the data to determine location and time settings. The **GNSS screen** is used to configure the CX300 GNSS settings to use satellites to determine location, or to use GNSS as a frequency and clock source.



GNSS Button

The CX300 can be configured to use the following types of GNSS systems:

- Global Positioning System (GPS)
- Global Navigation Satellite System (GLONASS - Russia)
- Galileo (European Union)
- BeiDou (China)
- Satellite Based Augmentation System (SBAS)

See section 4.5, “Setting up GNSS”, on page 4-12 for instructions to configure the test set’s GPS settings.



**NOTE**

GNSS requires use of a GNSS/GPS antenna connected to the GNSS Antenna connector.

**3.1.14.1 GNSS Lock Status**

The **GNSS Indicator**  is always displayed in the **Device Toolbar**, regardless of GPS position, and regardless of Lock Status. Lock Status is indicated by the **GNSS button**:

**Table 3-14 GNSS Lock Status**

**Locked**



A signal has been established with enough satellites to provide location information as specified by Fix Type.

**Searching**



The selected GNSS system has not achieved lock and is searching for satellites.



When GPS has obtained correct position information, the GPS Indicator is displayed in the Device Status Bar.



**NOTE**



The GPS lock icon indicator for Lock Status is available only while **GNSS** is set to On.

The **GNSS screen** contains the following controls and settings:

**Table 3-15 GNSS Controls and Settings**

<b>Control/Setting</b>	<b>Description</b>
<b>Antenna Power</b>	<p><b>Antenna Power</b> is used to power the antenna that is connected to the test set's GNSS Antenna.</p> <p>If the GNSS Antenna is powered by an external power source, turn <b>Antenna Power OFF</b>.</p> <p>If the GNSS Antenna is not powered by an external power source, turn <b>Antenna Power ON</b>.</p>
<b>Fix Type</b>	<p>Selects how the test set acquires a position fix with satellites to acquire a satellite link.</p> <p><b>2D Mode</b></p> <p>A 2D (two dimensional) position fix that includes only horizontal coordinates. <b>2D Mode</b> requires a minimum of three visible satellites.</p> <p><b>3D Mode</b></p> <p>A 3D (three dimensional) position fix that includes horizontal coordinates plus altitude. <b>3D Mode</b> requires a minimum of four visible satellites.</p> <p><b>Any</b></p> <p>Calculates a 3D position fix if possible, but reverts to 2D position if necessary.</p>
<b>GNSS</b>	<p>This turns GNSS function ON and OFF.</p> <p>When GNSS is turned ON, the GNSS Indicator is displayed in the <b>Device Toolbar</b>.</p>
<b>GNSS System</b>	<p>Selects the type or combination of types of GNSS systems to which the test set is being connected. The type of GNSS system selected should be supported in the region where you intend to conduct testing.</p> <p>To use Satellite Based Augmentation Systems (SBAS), select the option that provides SBAS (i.e., <i>system name</i> + SBAS. For example, GPS + SBAS).</p>
<b>Survey Mode</b>	<p><b>Dynamic</b></p> <p>Continuously calculates positioning for continuous location information.</p> <p><b>Auto</b></p> <p>Calculates positioning until accurate location information is determined. Switches to fixed position using accurate location information and switches to determine timing accuracy.</p>

Table 3-15 GNSS Controls and Settings (Continued)

Control/Setting	Description
<b>Elevation Limit</b>	This value represents the lowest point on the horizon on which the receiver will try to locate and obtain information from GNSS satellites.
 <b>NOTE</b>	Using satellites near the horizon may degrade performance.
<b>Minimum C/No (dB-Hz)</b>	This field specifies the minimum Carrier to Noise Ratio (C/No) for the satellite signals that will be used by the module's GNSS receiver.  The C/No is an indication of signal strength ranging from 0 to 50 dBHz.
 <b>NOTE</b>	Using satellites with a weak C/No may degrade performance.
<b>Antenna Time Bias (ns)</b>	This value represents the bias that is used to compensate for the delay introduced by the antenna, the antenna's cable, and if applicable, an in-line splitter or amplifier where absolute accuracy of PPS is important.
 <b>NOTE</b>	The default <b>Antenna Time Bias</b> value is 28, which is the optimal value for the VIAVI qualified antenna. If you are using a different antenna, determine the optimal bias value by referring to the vendor specifications for the antenna (and if applicable, splitter or amplifier), then specify the bias value in nanoseconds.

### 3.1.15 System Info Screen

The **System Info** (Information) **screen** lists the following information:

- Serial numbers for test set components
- Software version information
- Options that are supported and/or enabled on the test set

The **System Info screen** also contains controls to reset the test set to factory default settings, backup the test set's system files, and also shows installation options.



The following data is key product information which may be required when updating the test set, or when contacting VIAVI for technical support:

**Table 3-16 System Information**

System Information	Description
CX300 Serial Number	ComXpert platform serial number.
CX300 Module Serial Number	CX300 RF Application Module serial number.
<b>Installed Software</b>	
cx300-bundle-version	CX300 RF Application Module software version.
platform-version	ComXpert platform software version.

The **System Info screen** contains the following option controls and settings:



**Table 3-17 System Info Screen Controls and Settings**

Control/Setting	Description
<b>Import Options from USB</b>	Imports software options to the CX300. <a href="#">See section 4.11.1, “Enabling Software Options”, on page 4-23</a> for option installation procedure.
<b>Reset instruments to defaults</b>	Resets CX300 system and test settings to factory default values; process requires rebooting the test set. <a href="#">See section 4.10.2, “Reset Factory Default Settings”, on page 4-23</a> for information.
<b>Export log to USB device</b>	Saves the generated system information log to a USB device; an error message is generated if the system does not detect a USB device connected to one of the CX300’s USB connectors. <a href="#">See section 4.10.1, “Export System Information File”, on page 4-22</a> for information.
<b>Copy system info to file</b>	Generates a log file containing system information. The log file name is system-generated and named with the platform serial number. The log file can be exported to a USB device. <a href="#">See section 4.10.1, “Export System Information File”, on page 4-22</a> for more information.
<b>Secure erase instrument</b>	Initiates a procedure which erases all data stored on the test set.
 <b>NOTE</b>	When <b>Secure erase instrument</b> is performed, the CX300 is not operational until system software is reinstalled in the test set.

### 3.1.15.1 Viewing Available Software Options

Options that are available for the CX300 are listed in the **Base Options pane** of the **System Info screen**. An icon indicates the status of each option.

**Table 3-18 Option Status Indicators**

Icon	Status
	Option is enabled.
	Free-trial period for an option is expiring. When the trial period ends, a warning message appears. If a test is running when the trial period ends, the test will continue, but an expiration warning appears continuously until a license code is entered or a reset is performed.
	Option is not enabled. Contact the VIAVI Solutions Sales Office for information about enabling it.

### 3.1.16 StrataSync™ Screen

StrataSync™ is a hosted, cloud-based solution that provides asset, configuration, and test data management for VIAVI instruments. StrataSync™ simplifies device management by ensuring all instruments are up to date with the latest firmware, licenses, and options.

The following are just a few capabilities and features of StrataSync™:

- Notifies field personnel when firmware upgrades and instrument options are available via proactive, managed, application-aware notifications.
- Performs file storage, printing, and exporting.
- Provides clear dashboards and basic reports, enabling the analysis of network trends for proactive maintenance, improved reliability, and customer satisfaction.
- Intuitive, browser-based interface tracks and upgrades instruments and displays, prints, stores, and exports test results.

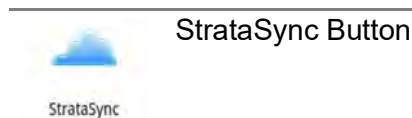

Refer to the VIAVI StrataSync™ website for more detailed information:

- <https://www.viavisolutions.com/en-us/products/stratasync>

To ensure the test set has the latest configuration settings, software options, updates, and ownership registration information, the CX300 should be synchronized with a VIAVI server when it is received from the factory, and on a routine basis thereafter.

When the test set is connected to the Internet, and contact has been made with the StrataSync™ server, a message appears asking the user to initiate the syncing process.

See section 4.13, “Synchronizing to the StrataSync™ Server”, on page 4-28 for information.

### 3.1.17 Video Player Screen

The CX300 contains a built-in video player which allows users to play saved video files such as training videos.



Video Player Button

### 3.1.18 Web Browser Screen

The CX300 contains a built-in Web browser which allows the user to connect to the Internet directly from the test set. When a Web browser window is open, the **Web Browser** (🌐) button is displayed in the **Device Toolbar** to indicate that a Web browser window is active, and to navigate between the **Web browser screen** and the system and test and measurement screens.

The Web browser contains back, forward, refresh, stop, and home buttons. Additional functions are available in the drop down menu located in the upper right corner of the screen. When the URL field is selected, a virtual keyboard is displayed on the screen. An external keyboard can also be used for control and navigation.

The Web browser menu accesses the following functions:

Table 3-19 Web Browser Controls

Control	Description
 Web Browser	Web Browser Button
<b>View Downloads</b>	Accesses recently downloaded files. Downloaded files can also be accessed from the <b>System &gt; Files screen</b> .
<b>Zoom In/Out</b>	The <b>Zoom In</b> and <b>Zoom Out</b> buttons adjust screen image size.



**Table 3-19 Web Browser Controls (Continued)**

<b>Control</b>	<b>Description</b>
<b>Reset Zoom</b>	The <b>Reset Zoom button</b> clears zoom settings and resets the display to default setting.
<b>Close Button</b>	This button is used to close the <b>Web browser screen</b> . When the <b>Web browser screen</b> is closed, the <b>Web Browser button</b> is removed from the <b>Device Toolbar</b> .

This page intentionally left blank.

# Configuring System Settings

This chapter contains step-by-step instructions for configuring various system settings and managing system settings and software. This chapter contains the following sections:

- [Configure Battery Saving Mode](#) . . . . . 4-2
- [Test Set Display Settings](#) . . . . . 4-2
- [Setting Date and Time](#) . . . . . 4-4
- [Establishing a Network Connection](#) . . . . . 4-5
- [Setting up GNSS](#) . . . . . 4-12
- [Configuring Timing Reference \(Clock Source\)](#) . . . . . 4-14
- [Remotely Operating the Test Set](#) . . . . . 4-15
- [Setting up a Bluetooth® Connection](#) . . . . . 4-15
- [Using Smart Access Anywhere](#) . . . . . 4-16
- [Managing System Information](#) . . . . . 4-22
- [Managing Options](#) . . . . . 4-23
- [Updating the System Software](#) . . . . . 4-24
- [Synchronizing to the StrataSync™ Server](#) . . . . . 4-28
- [Re-imaging the System](#) . . . . . 4-29
- [Capturing a Screen Shot](#) . . . . . 4-30



## NOTE

See [Chapter 3 “System Settings Screens”](#), for detailed information about system functions.

## 4.1 Configure Battery Saving Mode

The following procedure describes how to set the battery saving mode:

1. Navigate to the **Power Management screen**.
2. **Enable auto-off while on battery** check box.
3. Define elapsed time in the **Inactive Time** field.
4. Automatic shutdown prompt will display countdown until unit shuts down.

## 4.2 Test Set Display Settings

### 4.2.1 Calibrating the Touchscreen

The touchscreen can be calibrated remotely using a mouse, or locally via the screen. The following procedure applies to both local and remote operation.

1. Navigate to the **Display screen**.
2. Press the **Calibrate Touchscreen button**.
3. Follow on-screen prompts, selecting the target points within the time allowed.



#### NOTE

If targets points are not selected within the time allowed, the touchscreen calibration procedure is closed.

4. The procedure continues through a calibration point in each corner. The procedure is complete when each corner has been calibrated.

### 4.2.2 Adjust Screen Brightness

1. Change the brightness level by moving the slider left or right, as desired. Changes are effective immediately.



#### NOTE

- When the test set is on battery mode, it is normal for the screen to dim.
- Changes do not affect brightness of a remote connection to the device.

### 4.2.3 Change the Test Set Name

The following procedure describes how to change the name used to identify the test set for Bluetooth and remote connections. Change the test set name by using the following steps:

1. Navigate to the **Remote screen**.
2. Select the **Device Name** field.
3. Enter the desired name for the test set.
4. Press the **OK button** to apply the change.

### 4.2.4 Configuring the Screen Saver

The following procedure defines how to configure the screen saver.

1. Navigate to the **Display screen**.
2. To enable the screen saver, select the check box next to **Enable automatic screen saver**.
3. To change the message displayed as a screen saver, select the **Message** field, and type the message to be displayed.
4. Press the **OK button** to confirm.
5. To specify the time to wait until the screen saver begins:
  - a. Select the **Delay field**. Enter the amount of time to wait before the screen saver is activated.
  - b. Press the **OK button** to confirm.

### 4.2.5 Enable a screen saver password

The following procedure identifies how to enable a screen saver password.

1. Select the **Screen saver password** check box.
2. Enter a password in the field.
3. Press the **OK button** to confirm.
4. Record password for future reference.



#### CAUTION

If a screen saver is activated, and the password is lost or forgotten, the test set will have to be re-imaged to restore the test set to operating condition. See [section 4.14, "Re-imaging the System"](#), on page 4-29 for instructions.

## 4.3 Setting Date and Time

The following procedures identify how to set the international settings:

### 4.3.1 To Set International Settings

1. Proceed to the to the **Region screen**.
2. In the **Language** box, select the language for the user interface. The formatting standard changes automatically.
3. In the **Samples for selected formatting** box, the date, time, and number formatting appear.
4. To change the formatting standard, click the **Change formatting standard** box and select a country.
5. In the **Customize** box, click the check box next to **Use 24-hour time**.
6. Reboot the test set to apply the changes. The UI is now using the language specified.

### 4.3.2 To Set the Date

1. Proceed to the **Date and Time screen**.
2. Set the calendar to the desired month, day, and year. Changes are applied when selected.

### 4.3.3 To Set the Time Zone Proceed to the Date and Time screen.

1. Select the **Region, Country, and Area**.
2. Select the **Automatically adjust for daylight savings time** check box to enable DST.

### 4.3.4 To Manually Set the Time

1. Proceed to the **Date and Time screen**.
2. Use the **Up** and **Down arrows** to adjust the hour and minutes on the clock. Changes are applied when selected.
3. Select **AM** or **PM**. Changes are applied when selected.

### 4.3.5 To Set the Time Format

The following procedure describes how to set the date and time.

1. Proceed to the **Date and Time screen**.
2. Select the **Use 24-hour time** check box to display the time in HH:MM:SS format.

## 4.3.6 To Synchronize Time with Server Clock



### NOTE

Requires a valid NTP server address with which to synchronize.

The following procedure describes how to arrange and set up the test set to synchronize time with the server clock.

1. Arrange and set up the test set for network connectivity. [See section 4.7, “Remotely Operating the Test Set”, on page 4-15.](#)
2. Proceed to the **Date and Time screen**.
3. Select the **Set Clock Automatically** check box.
4. Enter the address for NTP Server in the drop down menu (NTP Server 1 or NTP Server 2).
5. Press the **OK button** to confirm.
6. When synchronization is complete, the time and date in the upper right corner of the screen updates to the server time and the message “Time successfully synchronized using NTP” is displayed on the screen.

## 4.4 Establishing a Network Connection

### 4.4.1 Establishing an Ethernet Connection



### NOTE

When the device is configured for DHCP mode, network information is likely to change when the device is connected, then reconnected to a network. If your procedure requires a known IP, configure the device for Static IP network mode of operation. Bluetooth and WiFi interfaces cannot be ON at the same time.

#### 4.4.1.1 Enable Network Connectivity

Network connectivity must be enabled in order to establish a connection to an Ethernet or WiFi network.

#### *To Enable Network Connectivity*

1. Go to the System Screen.
2. Select the **Network button**.

### 4.4.1.2 Establishing an Ethernet Connection

**To Establish an Ethernet Connection to the Device**

1. Connect the ethernet cable to the CX300’s **Ethernet connector**.
2. Connect the other end of the ethernet cable to an active LAN.
3. Navigate to the **Network panel** from the System Home Screen, Select the **Network button**.
4. Press the **LAN button** located on the left side of the screen. The UI updates to show parameters necessary to configure the CX300 to connect to a LAN.
5. Select desired network mode.
6. Additional settings are required based on the selected Network Mode of operation. See one of the appropriate sections to configure the device’s IP settings to match the LAN settings:
  - [LAN IPv4 Controls and Settings](#) .....3-6.
  - [LAN IPv6 Controls and Settings](#) .....3-7.
7. When all settings have been configured, press the **Network On/Off soft-key** to enable network connectivity. The device establishes an Ethernet connection to the LAN.
8. Additional settings are required based on the selected **Network Mode** of operation. See one of the appropriate sections to configure the device’s IP settings to match the LAN settings:
  - See section 4.4.2, “Establishing a WiFi Connection”, on page 4-9.
  - See section 4.4.1.2.2, “IPv4 Network Mode Settings”, on page 4-7.
  - See section 4.4.1.2.3, “IPv6 Network Mode Settings”, on page 4-8.

#### 4.4.1.2.1 IPv4/IPv6 Dual Stack Network Mode Settings

IP Dual Stack Address Modes	Setting
<b>DHCP</b>	No additional settings
<b>Static</b>	<a href="#">See section 4.4.1.2.2, “IPv4 Network Mode Settings”, on page 4-7.</a>
<b>Stateless</b>	<a href="#">See section 4.4.1.2.3, “IPv6 Network Mode Settings”, on page 4-8</a>

When all settings have been configured, select the **Network On/Off soft-key** to enable network connectivity. The device establishes an Ethernet connection to the LAN.



#### 4.4.1.2.2 IPv4 Network Mode Settings

IPv4 Address Mode	Setting
DHCP	No additional settings.
Static	IPv4 Address
	<ul style="list-style-type: none"><li>Enter the device's IP address (which will be used when accessing the provider network).</li></ul>
	IPv4 Netmask
	<ul style="list-style-type: none"><li>Enter the netmask address to indicate whether the packets are to be routed to other networks or subnetworks.</li></ul>
Static	IPv4 Gateway
	<ul style="list-style-type: none"><li>Enter the address for the gateway that is used to route packets that are not on the same subnet.</li></ul>
Static	IPv4 DNS Server
	<ul style="list-style-type: none"><li>Enter the address of the DNS server.</li></ul>
Shared	Share the IP from another interface (for multi interface mode).

When all settings have been configured, select the **Network On/Off soft-key** to enable network connectivity. The device establishes an Ethernet connection to the LAN.

### 4.4.1.2.3 IPv6 Network Mode Settings

IPv6 Address Mode	Setting
<b>DHCPv6</b>	No additional settings.
<b>Stateless</b>	IPv6 DNS Address Mode <ul style="list-style-type: none"><li>DHCPv6: <i>no additional settings to specify.</i></li><li>Manual: specify the IPv6 DNS Server address.</li></ul>
	IPv6 DNS Server <ul style="list-style-type: none"><li>Enter the address of the DNS server.</li></ul>
<b>Static</b>	IPv6 Global Address <ul style="list-style-type: none"><li>Enter the device's IPv6 address to access the global network.</li></ul>
	IPv6 Local Address <ul style="list-style-type: none"><li>Manual: Enter the IPv6 Local Address.</li><li>Automatic: Address is populated automatically.</li></ul>
	IPv6 Subnet Prefix Length <ul style="list-style-type: none"><li>Enter the subnet prefix length.</li></ul>
	IPv6 Gateway <ul style="list-style-type: none"><li>Enter the address for the gateway that is used to route packets that are not on the same subnet.</li></ul>
	IPv6 DNS Address Mode <ul style="list-style-type: none"><li>DHCPv6: no additional settings to specify.</li><li>Manual: Enter the IPv6 DNS Server address.</li></ul>
	IPv6 DNS Server <ul style="list-style-type: none"><li>Enter the address of the DNS server.</li></ul>

When all settings have been configured, select the **Network ON/Off soft-key** to enable network connectivity. The device establishes an ethernet connection to the LAN.

## 4.4.2 Establishing a WiFi Connection

The WiFi option allows the device to be connected to a wireless network to export reports, screen shots, or job tickets (using FTP), or update the device's firmware.



### NOTE

The CX300 supports 2.4 GHz and 5 GHz WiFi.

### 4.4.2.1 Adding a WiFi Network Profile

The CX300 can save up to 32 WiFi network profiles. If an access point does not broadcast a Service Set Identifier (SSID), a WiFi profile can be created manually. The device will save the profile, then automatically authenticate and establish a connection to the network when the following conditions are met:

- Network connectivity is enabled.
- The network's access point is in range.
- The network is determined to provide the best available access point (based on signal strength and/or encryption supported).



### NOTE

The CX300 automatically saves a WiFi network profile after successfully connecting to the WiFi network.

#### To Add a WiFi Network Profile

1. Enable network connectivity on the CX300. [See section 4.4.1.1, "Enable Network Connectivity", on page 4-5](#) for information.
2. Navigate to the **Network panel** (System button > Network button). The **System Network menu** appears.
3. Select the **WiFi button** located on the soft-key panel. The device immediately scans for WiFi networks and lists each network as an item.
4. Select **Add Network**. The Add WiFi Network controls and settings are displayed.
5. Specify the following settings:

Setting	Value
<b>SSID</b>	The SSID (Service Set Identifier) of the WiFi network.
<b>Password</b>	The password required to authenticate to the network. A password is not required if <b>Key Management</b> is set to None.

Setting	Value
<b>Key Management</b>	Select the Wi-Fi Protected Access (WPA) key management.
<b>Network Mode</b>	Select the Network Mode.
	Additional settings are required based on the selected Network Mode of operation. See the appropriate section to complete network configuration:
	<a href="#">See section 4.4.1.2.2, “IPv4 Network Mode Settings”, on page 4-7.</a>
	<a href="#">See section 4.4.1.2.3, “IPv6 Network Mode Settings”, on page 4-8.</a>
	<a href="#">See section 4.4.1.2.1, “IPv4/IPv6 Dual Stack Network Mode Settings”, on page 4-6.</a>

6. Return to the **System Network panel**. The network profile just created now appears on the list.

#### 4.4.2.2 Connecting to a WiFi Network

The CX300 can be connected to any compatible WiFi network within range of the device for which you have authorized access (and a password for authentication).

##### *To Connect to a WiFi Network*

1. Enable network connectivity on the CX300. [See section 4.4.1.1, “Enable Network Connectivity”, on page 4-5](#) for information.
2. Navigate to the **Network panel** (System button > Network button).
3. Select the **WiFi button** located on the soft-key panel.
4. The device automatically scans for WiFi networks and lists each network with the following status:

<b>A lock</b>	Indicates authentication is required to connect to a network.
<b>Saved, In Range</b>	Indicates that a profile for the network has been saved on the device, device is in range of the network and a connection can be established to the device.
<b>Saved, Out of Range</b>	Indicates that a profile for the network has been saved on the device, but the network is out of range and therefore, a connection cannot be established.
<b>Incompatible</b>	Indicates that a connection cannot be established to a network.
<b>Connected</b>	Indicates that the device has established a connection to the network.

The device automatically connects to the network determined to provide the best available access point (based on signal strength and/or encryption supported).

#### ***To Connect to a Different WiFi network***

1. Select the SSID of the WiFi network.
2. Configure the advanced settings (profile settings), forget a saved network, or connect to the network.
3. Select the **Connect button**.
  - Messages appear briefly indicating that the device is performing a four-way handshake, then authenticating to the network.
  - The status of the connection (Network Up) and details concerning the connection (IP address, netmask, gateway, and DNS server) appear at the top right of the menu.

The device is connected to the WiFi network.

## 4.5 Setting up GNSS

The following procedure describes how to arrange the CX300 to use GNSS settings for location, or as a frequency clock source.

See section 3.1.14, “GNSS Screen”, on page 3-20 as needed for a description of GNSS settings.

1. Navigate to the **GNSS screen**.
2. Set **Antenna Power** to ON or OFF based on whether or not the antenna is powered externally.
3. Set **GNSS** to On.
4. Open the **Fix Type menu** and select the type of position fix to be used.
5. Open the **GNSS System menu** and select a system that is supported in the region where testing will be performed.
6. Open the **Survey Mode menu** and select how positioning will be calculated.
7. In the **Elevation Limit (deg) field**, specify the elevation limit in degrees.



### NOTE

Using satellites near the horizon might degrade performance.

8. In **Minimum C/No (dB-Hz) field**, specify the minimum Carrier to Noise Ratio (C/No) for the satellite signals that will be used by the GNSS receiver.



### NOTE

Using satellites with a weak C/No might degrade performance.

9. In the **Antenna Time Bias field**, specify the optimal value.

## 4.5.1 Checking GNSS results

Confirm the following information is displayed on the **GNSS screen**:

- Latitude (deg): Distance north or south of the equator, measured in degrees ranging from 90° to +90°.
- Longitude (deg): Distance east or west of the prime meridian, usually measured in degrees ranging from 180° to +180°, which runs from the North Pole to the South Pole through Greenwich, England.
- Altitude (m): Height above Ellipsoid (HAE). The height coordinate determined from GPS observations is related to the surface of a Reference Ellipsoid (WGS84).

The coordinates are derived initially in the 3D Cartesian system (as XYZ values), and then for display/output purposes they are transformed to Latitude, Longitude, and (Ellipsoidal) Height using a well known formula to an ellipsoid, such as that associated with the WGS84 Datum (semi-major axis: 6378137m; inverse flattening: 298.257223563).

The surface of the ellipsoid is the zero ellipsoidal height datum. In Relative Positioning, the height component of the receiver whose coordinates are being determined relative to the Base Station, can also be related to an ellipsoid by transforming the baseline vector from the 3D form (DXDYDZ) to a change in Latitude, change in Longitude, and change in Ellipsoidal Height.

- Lock Status is indicated by the **GPS Indicator button**. See section 3.1.14.1, “GNSS Lock Status”, on page 3-21).

## 4.6 Configuring Timing Reference (Clock Source)

The following sections describe how to arrange the CX300 to configure the timing reference.

See section 3.1.13, “Clock Source Screen”, on page 3-19 for a description of any of the settings referenced in this section.

### 4.6.1 Internal Reference

The following procedure describes how to configure the CX300 to use the test set’s internal clock as a timing reference:

1. Navigate to the **Clock Source screen**.
2. Select **Internal** from the **Clock Source menu**.

The Clock Source Indicator is not displayed when Internal is selected as the clock source.

### 4.6.2 External Timing Reference

The following procedure describes how to configure the CX300 to use an external clock source as a timing reference:



#### NOTE

When selecting an external clock source, ensure that the clock source is connected to the test set and that the external clock source is accurate to within +/- 500 ppb.

1. Navigate to the **Clock Source screen**.
2. Connect the external reference to the CX300’s RF Input Connector.
3. Select the external reference from the **Clock Source menu**.

The Clock Source Indicator updates to identify the selected external reference.

### 4.6.3 GPS Timing Reference

The following procedure describes how to set the GNSS operation.

1. Arrange the test set for GNSS operation. See section 4.5, “Setting up GNSS”, on page 4-12).
2. Navigate to the **Clock Source screen**.
3. Select **GPS** from the **Clock Source menu**.

The **Clock Source Indicator** updates to identify the selected clock source.



## 4.7 Remotely Operating the Test Set

### 4.7.1 Establishing VNC Viewer Connection

*To View the UI Remotely:*

1. Proceed to the **Remote screen**.
2. Select the **Enable VNC Access** check box.
3. To require a password:
  - a. Select the **Require password for VNC access** check box.
  - b. Type a password in the **Remote access password** field.



#### NOTE

IPv6 Network Mode is disabled when a password is required.

This password applies to all remote-access tools; for example, VNC, FTP, and SSH.

### 4.7.2 Remote Programming Commands

The CX300 can be controlled over a network connection using remote programming commands. Refer to the *CX300 ComXpert Remote Programming Manual 22146776* for information and instructions.

## 4.8 Setting up a Bluetooth® Connection

The following procedures describes how to set up Bluetooth Connection.



#### NOTE

Bluetooth is a software option that must be enabled to use Bluetooth functionality.

The **Device Name** associated with the CX300 is configured on the **Remote screen**.

[See section 4.2.3, “Change the Test Set Name”, on page 4-3.](#)

1. Navigate to the **Bluetooth screen**.
2. Enable the following check boxes:
  - **Enable Bluetooth**
  - **Allow other devices to pair with this device**
3. Activate Bluetooth on the device that is to be paired with the CX300.

4. On the CX300, press the **Start Scanning button** to locate detectable devices in range:
  - The names of newly detected devices appear in the **Discovered Devices**.
  - The names of previously detected devices appear in the **Paired Devices** list.
5. Select the remote device with which to pair the CX300.
6. On the remote device, enter a pairing code if prompted, press the **Pair button** to pair the remote device with the CX300 Managing Network Certificates.

## 4.9 Using Smart Access Anywhere

Smart Access Anywhere is a utility function that allows users to view and control the CX300 user interface (UI) from a remote workstation. Click on the following link for information about the Smart Access Anywhere utility.

<https://www.viavisolutions.com/en-us/products/smart-access-anywhere-saa>

The Smart Access Anywhere utility is available for Windows®, iOS®, and Android®. The utility must be downloaded and extracted on the PC or mobile device that will be used to connect remotely to the CX300.

### 4.9.1 Downloading and Extracting the Utility

The following procedure describes how to download utility to a PC.

1. Open a browser on the workstation.
2. Type the following in the URL field: <http://smartaccess.updatemyunit.net>
3. Click on the **SmartAccessAnywhere\_Vxx.xx.xx.zip** link.
4. Press the **Save button**.
5. After the download is complete, the browser can be closed.
6. Go to the download directory, then extract the files from the zip file to the desired destination directory.
7. The utility is downloaded and extracted.

### 4.9.2 Download Utility to an iOS or Android Device

The following procedure describes how to download utility to an iOS or device.

1. Proceed to the Apple Store or Google Play to download and install the utility.

### 4.9.3 Establishing a Smart Access Anywhere Connection

The CX300 can be accessed from a remote location/device using a wired Ethernet connection, WiFi connection, or a smart-phone with Data Tethering. Before establishing a connection to the CX300, verify that port 22 (SSH) or 443 (HTTPS) is open on the PC.

#### 4.9.3.1 Wired Ethernet Connection

Figure 4-1 illustrates a CX300 connected to a workstation via a wired Ethernet connection to the Internet. Before establishing a wired connection, determine the CX300's IP address and configure the network proxy (if a proxy is used).

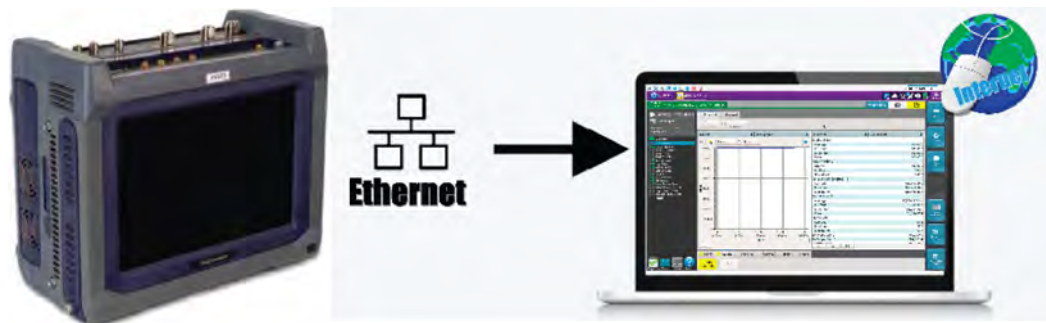

Figure 4-1 Wired Ethernet Connection Diagram

#### 4.9.3.2 WiFi Connection

Figure 4-2 illustrates a CX300 connected to a workstation using a WiFi connection.



Figure 4-2 WiFi Connection Diagram

### 4.9.3.3 Smart-phone with Data Tethering

The CX300 can be accessed remote from a smart-phone that supports data tethering. The remote connection requires using the smart-phone as a WiFi hotspot, or using a USB cable. [Figure 4-3](#) illustrates a CX300 connected to a workstation using a WiFi hotspot provided by a smart-phone that supports data tethering.



Figure 4-3 WiFi Smart-phone Connection Diagram

[Figure 4-4](#) illustrates a CX300 connected to a workstation using a USB connection to a smart-phone that supports data tethering.



Figure 4-4 USB Smart-phone Connection Diagram

## 4.9.4 Launching the Smart Access Utility

The following must be completed to use the Smart Access Anywhere utility:

- Establish a connection from a PC or mobile device to the CX300.
- Launch the utility on the CX300 to obtain the required remote access code.
- Launch the utility on your PC or mobile device, then enter the remote access code that was obtained from the CX300.

#### 4.9.4.1 Launching the Utility on the CX300

##### *To launch the utility on the CX300*

1. Navigate to the **System screen**.
2. Press the **Remote button**.
3. Press the **Connect button**.
4. The connection to Smart Access Anywhere Server is initiated.
5. After a connection is established to the server, the CX300 displays a message with the code that is required to access to the equipment remotely.
6. Record the code for future use or for other users who require access.

#### 4.9.4.2 Testing the Connection

The following procedure can be used to test the connection between the workstation and target CX300. The following procedure is recommended, but not required:

##### *To Test the Connection*

1. Launch the Smart Access Anywhere utility on the workstation.
2. Press the **Test connection button**. The test automatically launches.
3. To display connection log details in real time, press the **See full logs button**. The connection log appears, and provides the following information:
  - Upload and Download speed (in Kbyte/s) from device to server.
  - Latency between device and server (in ms).
4. After analyzing the results, perform one of the following:
  - Press the **Clear test results button** to delete the current table, and retest the connection if desired.
  - If connection is deemed to be valid, enter the access code and establish connection.

### 4.9.4.3 Launching the Utility on Computer or Mobile Device

After a connection is established with the CX300, launch the Smart Access Anywhere utility to update the device.

#### ***Displaying the CX300 User Interface***

1. Launch the Smart Access Anywhere utility:
  - On a PC, open the directory where the utility was installed. Launch the **SmartAccessAnywhere.exe** file.
  - On the mobile device, press the **Smart Access Anywhere button**. The utility opens.
2. Enter the access code in the field provided on the upper part of the screen.
3. Press the **Connect button** to validate the code.

The Smart Access Anywhere screen appears.



#### **NOTE**

After upgrading or rebooting a remote CX300, please wait at least two minutes before re-establishing the link between your workstation and the device.

## 4.9.5 Smart Access Utility - Viewing the CX300 UI

After the Smart Access utility has been launched, you can view the CX300 user interface (UI) on the external device's display.

### *To View the CX300 UI Remotely*

1. Select **Remote screen** from the utility's Introduction page.
2. The CX300 UI appears on the external device's display.
3. The **VNC button** located in the CX300 **Device Toolbar** indicates that the remote screen is active.

## 4.9.6 Transferring Files with Smart Access

A file can be transferred to and from the external device and the CX300.

### *To Transfer Files using Smart Access*

1. Select **Remote screen** from the utility's Introduction page.
2. A two-paneled window appears, showing the PC or mobile device directories (or storage devices) in one pane, and the CX300 directories (or storage devices) in the other pane.
3. In the "source" pane (the pane that has the file that you want to transfer), select the directory or storage device, then select the file to be transferred.
4. In the "destination" pane (the pane with the directory that you want to transfer the file to), select the destination directory for the file.
5. Select one of the following:
  - To transfer a file from an external device to the CX300, select **Upload**.
  - To transfer a file from the CX300 to an external device, select **Download**.
6. A dialog box appears asking you to verify the destination that was selected for the transferred file. Press the **OK button** to confirm the selection.
7. Press the **Save button** to transfer the file.

A message will appear at the bottom of the screen providing details concerning the status of the file transfer. After the transfer is complete, the message disappears and the transferred file is underlined in the workstation or instrument's file manager.



### **NOTE**

Files cannot be transferred in multiples; files must be transferred one at a time.

## 4.9.7 Managing Connection Settings

The following information about the current remote session can be viewed at any time.

### ***To Display Session Information***

1. Press the **Session icon** key.
2. Session details appear. This page gives information on the connection in real time.

### ***To Modify Connection Settings***

1. Select the **Session icon**.
2. Disconnect the session using the **Disconnect button**.
3. Select the **Network Settings button** from the **Session screen**.
4. The **Connection Settings screen** appears. The default connection is defined as Smart-guess (default).
5. Select Forced settings. Modify **SSL tunnel port** and/or **Internet proxy** as needed.
6. The Internet proxy configuration is available exclusively if the port selected is Alternative port (443) and if HTTPS packing is selected.



#### **NOTE**

If the default parameters need to be modified, VIAVI recommends you discuss it with your local network administrator.

7. After configuring the settings, select **Back to main page**.

## 4.10 Managing System Information

The following procedures describes how to manage system information

### 4.10.1 Export System Information File

#### ***To create a system information file and export the file to a USB device***

1. Connect a USB device to one of the test set's USB Connectors.
2. Navigate to the **System Home screen**.
3. Select **System Info**.
4. Select **Copy system info to file**.
5. Select **Export logs to USB stick**.
6. Log export was successful message will appear.



## 4.10.2 Reset Factory Default Settings

The following procedure resets the test set to factory default settings.

1. Proceed to the **System Home** screen.
2. Select **System Info**.
3. Select **Reset Instrument to defaults**.
4. At prompt, reboot the test set to apply the changes.



### NOTE

Remote access default setting is “OFF”; remote access to the test set will be lost when default settings are restored, and until the settings are configured locally.

## 4.10.3 Erase Test Set Data

This procedure erases all data stored on the test set.

1. Proceed and arrange to the **System Home** screen.
2. Select **System Info**.
3. Select **Secure erase instrument**.



### CAUTION

When **Secure erase instrument** is performed, the CX300 is not operational until system software is reinstalled in the test set.

## 4.11 Managing Options

The following procedures describe how to enable, review, and purchase software options.

### 4.11.1 Enabling Software Options

Software options may be available on the unit or purchased separately. For information about purchasing software options, contact the VIAVI Solutions Sales Office for your region.

See [section 3.1.15, “System Info Screen”, on page 3-23](#) for details about option information provided on the System Info screen.

## 4.11.2 Viewing Available software options

### To View Software Option

1. Proceed to the **System Info screen**.
2. Available options are listed in the **Base Options pane**.

## 4.11.3 Enabling Purchased Software Options



### NOTE

Before beginning this procedure, ensure that the USB device on which software option files are saved is available.

1. Proceed to the **System Info screen**.
2. Connect the USB device to a USB port on the top panel of the unit.
3. Press the **Import Options from USB button**. A confirmation message appears when the options are installed.
4. Restart the instrument, access the System Info tool, then confirm that each software option appears in the **Base Options pane** and is enabled.

## 4.12 Updating the System Software

The recommended method of updating the test set's software is via StrataSync™.

- See [“Synchronizing to the StrataSync™ Server”](#), section 4.13, on page 28 for information.

If StrataSync™ is not available, system software and solution firmware can be updated from a storage location, such as a USB device or a network directory.

This section describes the following procedures:

- [“USB Software Update Procedure”](#)
- [“Network Software Update Procedure”](#)

### 4.12.1 USB Software Update Procedure

Download the system software to a computer, then extract software files to a USB drive. VIAVI recommends that the USB drive have no other content stored on it.

The update process when using a USB drive involves the following procedures:

- [“Downloading and Extracting Software”](#)
- [“Performing the USB Software Update”](#)

### 4.12.1.1 Downloading and Extracting Software

The following procedure provides instructions to download and extract software to a USB drive.



#### NOTE

System software files are self-extracting software files

1. Download software from [VIAVI Software Updates and Downloads](#).
2. Select the link for the latest version of software.
3. Save the software file to a location on the computer.
4. Connect a USB device to the computer.
5. Navigate to the software file location. Open the file and select **Run**.
6. In the dialog that appears, click **Browse** to navigate to and select the USB drive.
7. Click **Extract** to initiate extraction of the system software files to the USB drive. Do not unplug the USB device from the computer while the files are extracting.
8. When all the files have been extracted, eject and disconnect the USB device from the computer.
9. Proceed to “[Performing the USB Software Update](#)”, section 4.12.1.2, on page 25.

### 4.12.1.2 Performing the USB Software Update

- The unit must have an uninterrupted supply of power during the software update. If necessary, connect the test set to a grounded AC Power supply.
- Make sure to have a USB drive available on which the extracted system software files are saved.

#### *To Perform the USB Update*

1. Plug the USB drive into the USB connector on the top panel of the test set.
2. Navigate to the **Upgrade screen**. Select **USB**.  
The release number of the software available on the USB drive appears.
3. To upgrade to a later release, press the **Start Upgrade button**.  
A dialog box appears with prompts to either exit all tests that are running, or cancel the update if the tests cannot be stopped.
4. Press the **OK button** to proceed with the software update. Do not disconnect the USB device from the test set during the update.
5. The test set automatically restarts when the update is completed.
6. After the test set has restarted, disconnect the USB device.

## 4.12.2 Network Software Update Procedure

The test set's system software can be updated over a network connection to a server where the updated software file has been stored. Software must be downloaded and extracted to the network location before proceeding with the update.

Using a network storage location to perform a software update involves the following steps:

- ["Download and Extract Software to Network"](#)
- ["Performing the USB Software Update"](#)

Before proceeding with the update, review the following recommendations:

- Use a wired network connection. [See section 4.4.1, "Establishing an Ethernet Connection", on page 4-5.](#)
- A unit that is behind a firewall might not be able to access the network location where the system software is located. Connect the unit over a public network instead.
- The unit must have an uninterrupted supply of power during the software update. If necessary, connect the test set to a grounded AC Power supply.

### 4.12.2.1 Download and Extract Software to Network

The following procedure provides instructions to download and extract software to a network directory:



#### NOTE

System software files are self-extracting software files

1. Download software from [VIAVI Software Updates and Downloads](#).
2. Select the link for the latest version of software.
3. Save the software file to a location on the computer.
4. Navigate to the software file location. Open the file and select **Run**.
5. In the dialog box that appears, click **Browse** to navigate to, and select the network directory for the location where the files will be extracted.
6. Click **Extract** to initiate extraction of the system software files to the network directory.
7. When all files have been extracted, proceed to ["Performing the USB Software Update" on page 4-25.](#)

### 4.12.2.2 Performing Network Software update



#### NOTE

The software update can take several minutes, depending on the speed and reliability of the network.

The following information describes how to perform network update.

#### ***To Perform the Network Update***

1. Navigate to the **Upgrade screen**. Select **Network**.
2. Perform one of the following:
  - a. Enter the server address.
  - b. Enter the address where the software file is located; for example, the FTP address, server IP address or host name, and the proxy server address (if necessary), as well as the access credentials.
3. Press the **Connect button**.
4. After the unit accesses the server, select the link for the software file for the unit.
5. Press the **Start Upgrade button**.
  - A dialog box appears with prompts to either exit all tests that are running or cancel the update if the tests cannot be stopped.
  - The test set automatically restarts when the update is completed.
6. After the test set has restarted, disconnect the USB device.

## 4.13 Synchronizing to the StrataSync™ Server

To automatically obtain the latest configuration settings, software options, updates and ownership registration information, the unit should be synchronized with a VIAVI server via the Internet using an optional subscription-based service called StrataSync™.

In addition to the latest operating software, synchronization also uploads user files saved on the unit to the StrataSync™ server. A connection to the Internet would be provided upon receipt of the unit, and on a regular (daily) basis thereafter. This also ensures the most currently issued options and updates are available to the unit, and allows all user information to be backed up.

The unit must be able to connect to the Internet over Ethernet or Wi-Fi. When an Internet connection is available and the unit is connected to the StrataSync™ server, a request to initiate the syncing process appears.

### 4.13.1 Synchronize StrataSync™ Server



#### NOTE

Ensure that network settings are configured on the unit via the **Network** system tool. VIAVI recommends setting the IP mode to DHCP.

1. Proceed to the **System Home screen**.
2. Press the **StrataSync button**.
3. Verify that the server address appears in the **Server Address** field. The default server address is [stratasync.viavisolutions.com](http://stratasync.viavisolutions.com).
4. Enter the ID of the unit in the **Account ID** field.

Synchronization cannot occur without the entry of a pre-approved, unique account ID obtained from VIAVI. Ensure that an account ID is available before attempting to access the StrataSync™ server.

5. Optionally, enter an ID in the **Technician ID** field.  
A default technician ID is provided. This ID can be modified at any time.
6. Press the **Start Sync button** to initiate a connection to the StrataSync™ server.  
Synchronization begins when a connection to the server is established.



#### NOTE

During Synchronization, icons indicating progress and either the failure or completion of the process are displayed.

When an error or failure occurs, a message appears, detailing the possible issue.

## 4.14 Re-imaging the System

Re-image the system if the unit has become inoperable and cannot be rebooted.



### NOTE

Re-imaging deletes all files stored on the internal flash of the unit and reinstalls the system software.

Perform the following procedure to re-image the System.

1. Ensure that the unit will have an uninterrupted supply of power during the re-image. If necessary, connect the AC Power Adapter/Cord to the unit.



### WARNING:

Electrical shock may result in serious injury or death.

- Be sure the AC Power Adapter/Cord is connected to the correct voltage mains.
  - Do not use the adapter outdoors or in wet locations.
  - Use only the AC Power Adapter/Cord supplied with the unit.
2. Confirm that a USB drive, on which extracted system software files are saved, is available. Connect the USB drive into the USB connector on the top panel of the unit.
  3. Press the **Power button** to turn the CX300 Off, then On.
    - The re-imaging process starts. Do not unplug the USB drive from the unit.
    - The unit automatically restarts when the update is completed.
  4. After the unit has restarted, unplug the USB drive.

## 4.15 Capturing a Screen Shot

To capture an image of the current screen.

### **To Capture a Screen Shot**

1. Access the **Test Controls Toolbar** and select the **Screen Capture Button**.

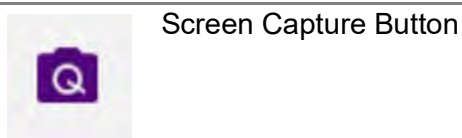

2. Enter a name for the screen shot.
3. The PNG file is saved to the internal file manager.



### **NOTE**

The images can be viewed on the test set through the Folder Button on the Test Controls Toolbar.

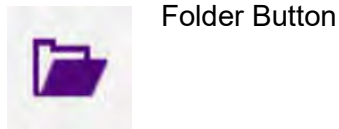



# Test and Measurement Functions

Contents in this chapter are as follows:

• Test Modes and Measurements . . . . .	5-2
• Overview of Test and Measurement Screens . . . . .	5-3
• Accessing Test Controls and Settings . . . . .	5-14
• CX300 Generators . . . . .	5-15
• CX300 Receive Functions . . . . .	5-21
• CX300 Meters . . . . .	5-27
• Audio Controls and Signal Routing . . . . .	5-42
• DVM (Digital Voltmeter) . . . . .	5-43
• Tone Decoding . . . . .	5-44
• Tone Encoding . . . . .	5-45
• Normalize . . . . .	5-51
• Frequency List . . . . .	5-52
• Channel Analyzer . . . . .	5-53
• Oscilloscope . . . . .	5-58
• Spectrum Analyzer . . . . .	5-60
• AutoTest Mode . . . . .	5-71
• Navigation Diagrams . . . . .	5-75



## NOTE

Analog measurement functions are standard CX300 measurements. Optional measurements, such as P25, are described in option specific manuals.

## 5.1 Test Modes and Measurements

The CX300 provides several standard test and measurement functions which allow the user to evaluate the transmit and receive performance of an analog communication system. The term “mode of operation” is used to refer to the combined selection of the test mode and measurement type. Each mode of operation contains controls and settings that are used to operate the test and measurement functions that are available in the selected mode of operation. The CX300 contains the following test modes and measurements:

- Communications Test Mode
- Spectrum Analyzer
- AutoTest Mode

### 5.1.1 Communications Test Mode

Communications Test mode supports full duplex, Transmit and Receive capabilities, providing simultaneous access to RF Generator and RF Receiver functions. Communications test mode would typically be used to evaluate the duplex, transmit and receive performance of radios that are capable of radio operation.

### 5.1.2 Spectrum Analyzer Mode

Spectrum Analyzer mode provides access to the CX300's Spectrum Analyzer. The Spectrum Analyzer is equipped with controls and settings that allow the user to reliably detect and characterize RF signals over time. [See section 5.15, “Spectrum Analyzer”, on page 5-60](#) for a description of the Spectrum Analyzer.

### 5.1.3 Auto-Test Mode

AutoTest mode provides access to the CX300 AutoTest function. AutoTest is used to automatically test specific devices for functionality without having to manually set each frequency and/or level. [See section 5.16, “AutoTest Mode”, on page 5-71](#) for a description of Auto-Test.

## 5.2 Overview of Test and Measurement Screens

This section provides a general overview of how to select modes of operation, how to navigate the user interface (UI), and how to access test screens, controls, and settings.





### NOTE

Test and Measurement screen content changes according to the selected mode of operation, the type of measurement, user selections, and options installed in the test set.

### 5.2.1 Test Home Screen

The **Test Home Screen**, provides access to the device's test and measurement functions.

#### To Display the Test Home Screen

- From a test screen, press the  **Home button**.
- From a system screen, select the  **CX300 ComXpert button**, then press the  **Home button**.

The layout of the **Test Home Screen** will resemble the example shown in [Figure 5-1](#). The **Test Home Screen** is divided into the following areas:

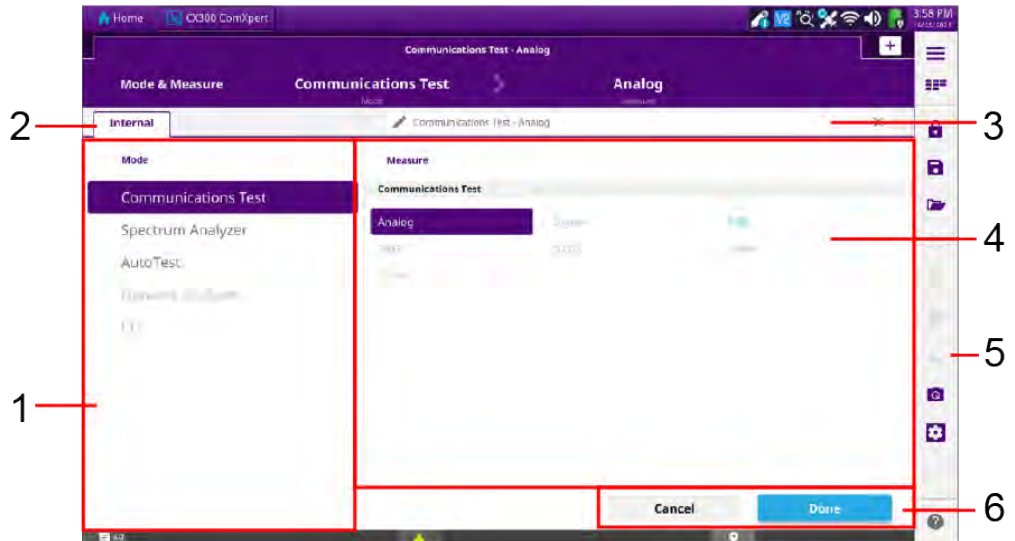



Figure 5-1 Test Home Screen - Layout Diagram

**Table 5-1 Test Home Screen Layout Description**

#	Name	Description
1	<b>Mode Pane</b>	This pane lists the test modes of operation that are available on the device. The content in the Measurement pane updates based on the item selected in this section. <a href="#">See section 5.1, “Test Modes and Measurements”, on page 5-2</a> for detailed descriptions of the CX300 modes of operation.
2	<b>Module Tab</b>	This indicates the active hardware module which is currently limited to the CX300 RF Module (Internal).
3	<b>Title Box</b>	<p>The <b>Title Box</b> displays the name of the selected test configuration.</p> <ul style="list-style-type: none"> <li>The default name of a test is [name of mode] dash (-) [name of measure] (e.g. Communications Test - Analog).</li> <li>The test title is edited by pressing the <b>Edit button</b> . The use of custom names could be helpful when creating a UI configuration that will be saved for later use or when multiple measurement tabs are active.</li> </ul>
4	<b>Measurement Pane</b>	This section of the screen lists the measurements that are available for the selected test mode. The content in this section updates based on the selected test mode.
5	<b>Test Controls Toolbar</b>	This section of the screen contains buttons that control UI layout, and access test and measurement functions and settings.
6	<b>Done/Cancel Controls</b>	<p>The <b>Cancel button</b> voids the selection and reverts to the last viewed test screen.</p> <p>The <b>Done button</b> confirms the selection and loads the selected mode of operation.</p>

## 5.2.2 Screen Navigation Diagrams

[See section 5.17, “Navigation Diagrams”, on page 5-75](#) for how to navigate and access test functions, controls, and settings.

### 5.2.3 Test Screen Layout

The layout of CX300 test screens changes based on factors such as the selected mode of operation, the type of measurement selected (e.g. P25 or Analog), active functions, and user selections. Figure 5-2 provides an example of how a CX300 test screen may appear.

#### To Select a Mode of Operation

1. Navigate to the **Test Home Screen**.
2. Select the desired **mode** (e.g. Communications Test, Spectrum Analyzer and AutoTest).
3. Select the type of **measurement** (e.g. Analog or P25, if applicable).
4. Select the type of measurement again, or select the **Done** button, to load the selected test and measurement.
5. Use QuickSwitch™ to quickly toggle between Duplex, Transmit, and **Receiver Testing**.



#### NOTE

QuickSwitch does not appear on all screens, e.g. Spectrum Analyzer, Auto-Test, etc.

The UI updates to display the test screen as it was configured during the last user session for the selected mode of operation. Test Screens are divided into the following areas:

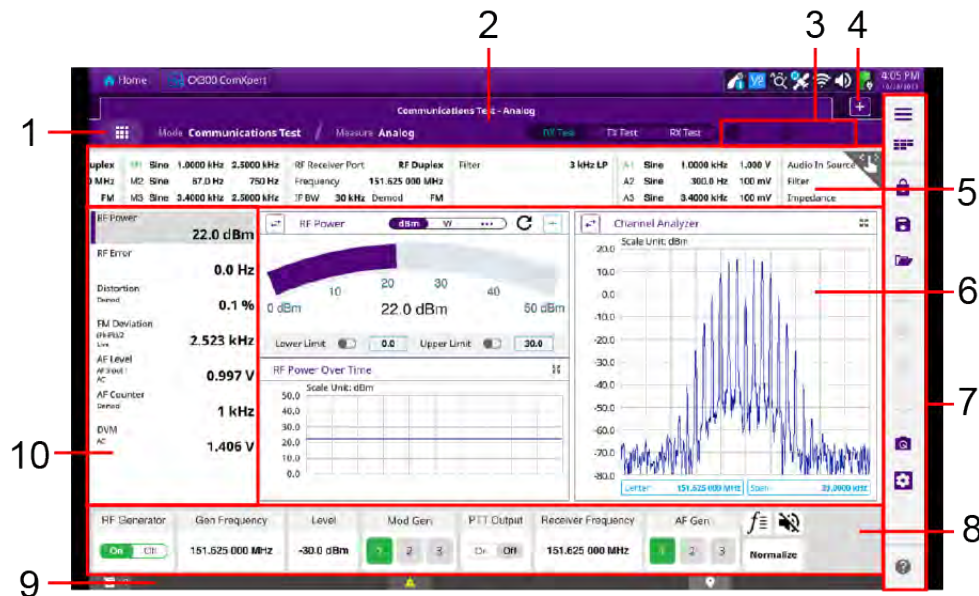

Figure 5-2 Example of Test and Measurement Main Screen

**Table 5-2 Test Screen Layout Descriptions**

<b>Idx#</b>	<b>Name</b>	<b>Description</b>
1	<b>Home Button</b>	The <b>Home Button</b> displays the <b>Test Home Screen</b> (Figure 5-1).
2	<b>Title Bar</b>	Displays the test title and the measurement that is selected. The test title can be edited on the <b>Test Home Screen</b> .
3	<b>Status Indicators</b>	This area of the display is used to display status indicators. See section 5.2.4, “CX300 Test Controls Toolbar”, on page 5-7.
4	<b>Add Measurement Button</b>	This button is used to create multiple measurement tabs on the display. See section 5.2.5, “Using Multiple Measurement Tabs”, on page 5-9, for information about this function.
5	<b>Test Settings Toolbar</b>	This section of the screen displays the generate and receive functions that are available in the selected mode of operation. Selecting a button from the toolbar opens the <b>Test Settings menu</b> to the controls and settings menu for the selected test and measurement function.
6	<b>Measurement Panes</b>	This section of the display is populated by two user-configurable measurement panes. The meter or graph displayed on each pane is selected using the button in the center of each measurement pane. See “Navigation Diagrams”.
7	<b>Test Controls Toolbar</b>	This section of the screen contains buttons that control UI layout and access test and measurement functions and settings. See section 5.2.4, “CX300 Test Controls Toolbar”, on page 5-7 for a description of these buttons.
8	<b>Quick Access Toolbar</b>	This toolbar provides quick access to controls and parameters that are commonly used in the selected mode of operation. The controls and settings located in this toolbar change based on the selected test mode of operation. See “Navigation Diagrams”.
9	<b>Device Status Bar</b>	The Device Status Bar displays various status indicators as described in section 2.7.3, on page 2-15.
10	<b>Meter Reading Pane</b>	The Meter Reading pane provides a quick view of meter readings. The meters displayed in this area depend on the mode of operation, the demodulation type, and noise meter selections. See “Navigation Diagrams”.
11	<b>Measurement Buttons</b>	These buttons are used to select the meter or graph that is displayed on the Measurement Panes. See “Navigation Diagrams”.

## 5.2.4 CX300 Test Controls Toolbar

To operate the CX300 efficiently, the user should become familiar with the buttons located in the Test Controls Toolbar. To activate any of these functions, momentarily push and release the button.

Table 5-3 CX300 Test Function Controls













Button	Name	Description
	<b>Home Button</b>	This <b>Home Button</b> displays the CX300 <b>Test Home Screen</b> .
	<b>Test Settings Button</b>	This <b>Test Setting Button</b> opens and closes the <b>Test Settings menu</b> . The <b>Test Settings menu</b> contains buttons that open sub-menus that contain test and measurement controls and settings for the selected test or measurement function.
	<b>Full Test Settings Button</b>	This <b>Full Test Setting Button</b> displays all controls and settings for each test and measurement function that is available in the selected mode of operation. Selecting one of the settings or buttons opens a configuration window or alters the state of the setting.
	<b>Hold Button</b>	Pressing the <b>Hold button</b> halts all measurements from updating to any active plot fields; the plot is frozen and does not update until the measurement is unlocked.   When a measurement is locked, the Hold Indicator is displayed above the <b>Test Settings Toolbar</b> .
	<b>Save Button</b>	Pressing the <b>Save button</b> displays controls and settings that are used to save information or generate reports.  <a href="#">See section 7.1.1, "Saving Files", on page 7-2</a> for information.
	<b>Load File Button</b>	Pressing the <b>Load File button</b> displays controls and settings that are used to display a file on the CX300's UI. Files can be loaded from the device's internal storage or an external storage location.  <a href="#">See section 7.1.5, "Loading Files", on page 7-4</a> for information.
	<b>Auto Scale Button</b>	When the <b>Auto Scale button</b> is selected the system sets the plot scales to a setting appropriate to the characteristics identified in the received signal.

Table 5-3 CX300 Test Function Controls (Continued)



Button	Name	Description
	<b>Marker Reading Button</b>	This <b>Marker Reading Button</b> displays the <b>Marker Readings Toolbar</b> . The information displayed in this toolbar is described in <a href="#">“Marker Readings Pane”</a> .
	<b>Marker Controls Button</b>	This <b>Marker Control Button</b> displays the <b>Marker Controls Toolbar</b> . The toolbar contains controls used to add and delete markers, configure marker readings, and adjust marker position. The controls located in this toolbar are described in <a href="#">“Marker Controls Toolbar”</a> .
	<b>Marker to Peak Button</b>	This is a quick-access button that moves the active marker to the highest peak on the trace. This <b>Marker to Peak Button</b> performs the same function as the <b>Peak Search button</b> located in the <b>Marker Controls Toolbar</b> . When all markers are off, pressing the button adds Marker 1 (M1) and positions the marker at the highest peak on the trace.
	<b>Screen Capture Button</b>	This is a quick-access button that captures and saves the current screen. The status message <code>Quick Saved the Screen</code> is displayed in the <b>System Status bar</b> to confirm the screen was saved. The screen is saved to the CX300’s internal storage and named using the following format: Quick__YYMMDDHHMMSS.png <a href="#">See section 7.1.1, “Saving Files”, on page 7-2</a> for additional information about saving screens.
	<b>System Settings Button</b>	This is a quick-access button that allows access to System Information and System Settings.



## 5.2.5 Using Multiple Measurement Tabs

CX300 Test mode supports multiple measurement tabs. The additional measurement tabs can be configured for different measurement modes.

### To Add a Measurement Tab

1. Press the **Add Measurement Tab Button** (  ). A new tab is created that displays the **Test Home Screen**.
2. Select the desired mode and measurement.
3. Optional: Use the **Edit Button** (  ) to edit the measurement tab Title Bar (recommended when creating multiple tabs with the same measurement mode).
4. Press the **Done Button** to launch the new measurement tab.

### Deleting Measurement Tabs

When multiple tabs are active on the display, tabs are closed using the **Close Button** (  ) located in the upper right corner of the tab. Unsaved data is lost when a measurement tab is closed.

## 5.2.6 Markers

A marker is used to obtain information about a specific point on a trace. The CX300 supports up to six markers; each marker can be configured independently. The X and Y coordinates of the trace are displayed when the marker is placed on any position of the trace. The position displaying the marker's X and Y coordinates may be slightly different for each measurement mode (refer to the description of each measurement).

This section describes marker controls, marker measurements, and how to add, delete and position markers.

### 5.2.6.1 Marker Controls Toolbar

 The Marker Controls Toolbar is accessed by selecting the **Marker Controls** button located on the Test Functions Toolbar. The following controls and settings are located in the Marker Controls Toolbar:

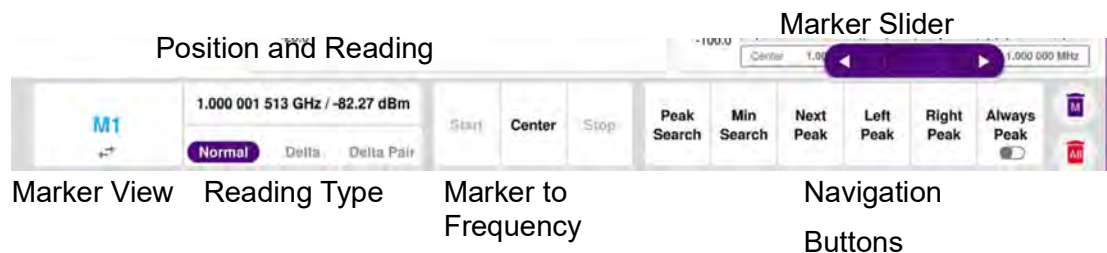



Figure 5-3 Marker Controls Toolbar



**Table 5-4 Marker Toolbar Controls and Settings**

Data Field	Description
<b>Marker View Button</b>	<p>Pressing this button opens a pane that contains controls and settings that are used to add and/or select a marker. A marker label is grayed out to indicate that the marker is not active on the display (off).</p> <ul style="list-style-type: none"> <li>• Selecting an inactive marker from the menu adds the marker to the plot field.</li> <li>• Selecting an active marker displays the marker above the plot field.</li> </ul>
<b>Marker Position</b>	<p>Marker position can be set manually to a specific location by entering numeric values, by using the <b>Marker Slider</b> (purple slider bar) to move the selected marker, or by using the Marker Navigation buttons.</p> <p>Marker position on an analyzer indicates the frequency; marker position on the Oscilloscope indicates time.</p> <p><b>Marker Indicator Line</b></p> <p>When a marker is displayed on a plot field, the UI displays a red vertical position line that indicates the position of the selected marker.</p>
<b>Marker Measurement Type</b>	<p>Markers can be configured to provide three different types of measurements: Normal, Delta, and Delta pair.</p> <p><b>Normal</b></p> <p>Normal marker type provides the reading of a marker position on the trace along with the marker number between one and six.</p>
	<p><b>Delta</b></p> <p>Delta marker type is associated with an active Normal marker. A normal marker must be active before a Delta marker can be set.</p> <p>The following occurs when the Delta Marker button is pressed:</p> <ul style="list-style-type: none"> <li>• The position set by the Delta marker becomes the reference position of the Normal marker.</li> <li>• The marker's X and Y values display the difference compared with the Delta marker.</li> <li>• The Marker label updates to "D#" to indicate delta measurement is selected.</li> </ul>

**Table 5-4 Marker Toolbar Controls and Settings (Continued)**

Data Field	Description
Marker Measurement Type (cont)	
<b>Delta Pair</b>	
<p>Delta Pair marker type is associated with an active Normal marker. A normal marker must be active before a Delta Pair marker can be set.</p> <p>The following occurs when the <b>Delta Pair Marker</b> button is pressed:</p> <ul style="list-style-type: none"> <li>• The position set by the Delta Pair marker becomes the reference position of the Normal marker.</li> <li>• The marker's X and Y values displays the difference compared with the Delta Pair marker.</li> <li>• The reference position will be varied in accordance with trace change.</li> <li>• The Marker label updates to "D#" to indicate delta pair measurement is selected.</li> </ul>	
<b>Start Button</b>	Sets the frequency of the active marker to the start frequency of the frequency span.
<b>Center Button</b>	Sets the frequency of the active marker to the center frequency of the frequency span.
<b>Stop Button</b>	Sets the frequency of the active marker to the stop frequency of the frequency span.
<b>Navigation Buttons</b>	
<p>The following buttons move the selected marker as described below.</p>	
<b>Peak Search</b>	<p>Moves the active marker to the highest peak of the trace. The Quick Access <b>Peak Search</b> button  located in the Test Function Toolbar performs the same function.</p>
<b>Min Search</b>	Moves the active marker to the lowest peak of the trace.
<b>Next Peak</b>	Moves the active marker to the second highest peak of the trace.
<b>Left Peak</b>	Moves the active marker to the highest peak to the left of its current position.
<b>Right Peak</b>	Moves the active marker to the highest peak to the right of its current position.
<b>Always Peak</b>	<p>When the <b>Always Peak</b> is set to <b>On</b>, the instrument moves the active marker automatically to the highest peak of the trace every time the trace is refreshed.</p>

**Table 5-4 Marker Toolbar Controls and Settings (Continued)**

Data Field	Description
<b>Marker Delete Button</b>	Pressing the <b>Marker Delete</b> button (  ) removes the selected marker from the plot field.
<b>Delete All Markers Button</b>	Pressing the <b>Delete All Markers</b> button (  ) turns off all markers displayed on the plot field. Pressing the <b>Marker View</b> button for each marker restores the markers at their previous positions. If a measurement mode is changed, current settings are not restored unless the UI configuration is saved.

### 5.2.6.2 Marker Readings Pane

Press the **Marker Readings** button (  ) to display the Marker Readings pane. The following data fields are found on the Marker Reading pane:

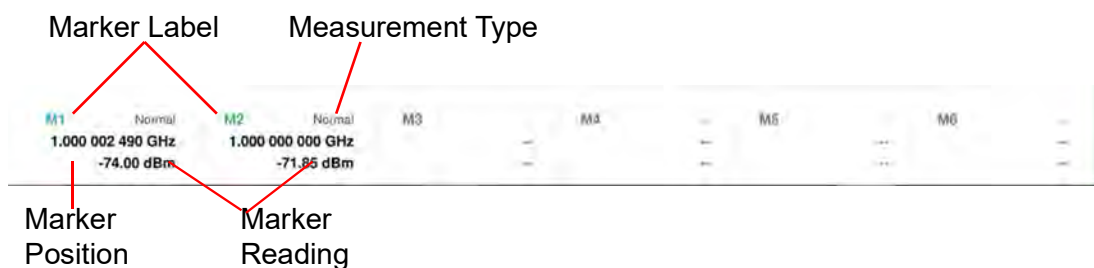

**Figure 5-4 Marker Controls Toolbar**

**Table 5-5 Marker Reading Pane Data Fields**

Control/Setting	Description
<b>Marker Label</b>	Indicates the marker number and color associated with each marker.
<b>Measurement Type</b>	Indicates the measurement type selected for the marker reading. " <a href="#">Marker Measurement Type</a> " on page 5-10.
<b>Marker Position</b>	Displays the measurement position. " <a href="#">Marker Position</a> " on page 5-10 or " <a href="#">To Position a Marker</a> " on page 5-13.
<b>Marker Reading</b>	Displays the reading at the marker's position.



### 5.2.6.3 Configuring Markers

The following procedure describes how to configure markers.

#### **To Add a Marker**

1. If the Marker Controls Toolbar is not already visible, press the **Marker Controls Button** (  ) to open the Marker Controls Toolbar.
2. Press the **Marker View** button.
3. Press M1 > M6 to add the desired marker to the plot field.

#### **To Delete a Marker**

1. If the Marker Controls Toolbar is not already visible, press the **Marker Controls Button** (  ) to open the Marker Controls Toolbar.
2. Press the **Marker View Button**.
3. Select the marker you want to delete.
4. Press the **Marker Delete Button** (  ) to delete the marker.

#### **To Position a Marker**

1. If the Marker Controls Toolbar is not already visible, press the **Marker Controls Button** (  ) to open the Marker Controls Toolbar.
2. Press the **Marker View Button**.
3. Select the marker you want to move.
4. Use the **Marker Position** field or one of the Marker Navigation buttons to move the selected marker.

#### **To Create Delta Measurements**

1. Add a marker to the plot field.
2. Press the **Delta** or **Delta Pair Button**.

## 5.3 Accessing Test Controls and Settings

The controls and settings used to configure the CX300 test and measurement functions are accessed using any of the methods described below. See “[Navigation Diagrams](#)” for how to access test settings menus.

**Table 5-6 Test Controls and Settings**

---

### Method 1 - Test Settings Menu

1. Press the **Test Settings Menu Button** (  ) to open the **Test Settings menu**.
2. Navigate through the **Test Settings menu** to the desired function.
3. Select the function from the menu to access function controls and parameters.
4. Select the parameter from the **Test Settings menu**.
5. Configure the parameter as desired.

### Method 2 - Full Test Settings Menu

1. Press the **Full Test Settings Button** (  ) to open the **Full Test Settings menu**.
2. Select the desired control or setting.
3. Configure the parameter as desired.

### Method 3 - Test Settings Block

1. Press the **Test Setting Block** from the **Parameter Toolbar** to open the **Test Settings menu**.
  2. Select the desired control or setting.
  3. Configure the parameter as desired.
-

## 5.4 CX300 Generators

### 5.4.1 RF Generator

The RF Generator provides users with a signal source of known parameters which can be used to evaluate the receive performance of the Unit Under Test (UUT). When configuring RF generator settings, configure the characteristics of the RF signal according to the capabilities of the receiver, the test requirements, and the hardware configuration of the Test Set.

RF Generator controls and settings are configured from the **RF Generator settings menu**. Some controls are also accessed from the **Quick Access Toolbar** or **Test Settings Toolbar**. The following controls and settings are used to configure the characteristics of the generated RF signal:

**Table 5-7 RF Generator Controls and Settings**

Control/Setting	Description
<b>Port</b>	The RF Generator <b>Port</b> should be selected according to the properties of the outgoing signal and to the requirements of the test that is being performed.
	<p><b>RF Output</b></p> <p>When <b>RF Output</b> is selected, the RF Generator uses the test set's dedicated RF output connector to output the signal. The RF Output connector provides the maximum RF output level from the RF Generator and therefore, should be selected when test parameters require maximum RF output level.</p> <p><b>RF Duplex</b></p> <p>When <b>RF Duplex</b> is selected, the RF Generator uses the device's high-power, input/output connector. RF Duplex should be selected when performing high power measurements.</p>
<b>Frequency</b>	This field defines the frequency of the signal generated by the RF Generator. The RF Generator frequency should be set according to the following: <ul style="list-style-type: none"> <li>The test being performed.</li> <li>The frequency range of the receiver.</li> </ul>
<b>Enable</b>	The <b>Enable toggle switch</b> turns the RF Generator output ON and OFF.
<b>Level</b>	RF Generator <b>Level</b> should be set to a value appropriate for the receive capabilities of the UUT. When configuring the equipment for testing, use the RF Generator connector best suited to the <b>Level</b> setting.

Table 5-7 RF Generator Controls and Settings (Continued)

Control/Setting	Description
	<b>NOTE</b> The RF Generator <b>Level</b> should not exceed the approved rating for the input port selected on the receiver.
<b>Level Offset</b>	The RF Generator <b>Level Offset</b> accounts for a loss or gain to be inserted into the RF path between the CX300's generator output connector and the Unit Under Test. The <b>Level Offset</b> field defines the value that is applied to the RF Generator's power level. <ul style="list-style-type: none"><li>• The offset value is indicated in +dB for positive (gain) values.</li><li>• The offset value is indicated in -dB for negative (loss) values.</li></ul>

### 5.4.1.1 Configuring the RF Generator

The RF Generator should be configured according to the capabilities of the receiver. Refer to the receiver's input ratings to ensure the Generator Output Level does not exceed the operational capabilities of the receiver.

*The following information about configuring the RF Generator.*

1. Select **Communications Test** mode of operation.
2. Select measurement mode (e.g. **Analog**) and press the **Done** button.
3. Press the **Full Test Settings** button (  ) to open the **Full Test Settings** menu.
4. Select the RF Generator **Port**.
5. Define the RF Generator **Frequency**.
6. Define the RF Generator **Level**.
7. If desired, define the RF Generator **Level Offset**.
8. Set the RF Generator **Enable** toggle switch to **ON**.

The CX300 is now generating an RF signal.



## 5.4.2 Analog Mod (Analog Modulation) Generator

The CX300 contains three internal modulation generators and uses an external modulation source. The CX300's internal modulation generators can be configured to output signals of various modulation characteristics.

Analog Modulation parameters are used to define the modulation characteristics applied to the outgoing RF signal, or to configure the CX300 to utilize an external modulation generator. The following controls and settings are used to configure the device's modulation generators:

**Table 5-8 Analog Modulation Controls and Settings**

Parameter	Description
<b>Mod Type</b>	Selects the type of modulation that will be applied to the generated signal.
<b>Mod Enable</b>	The CX300 supports three internal modulation generators. The <b>Mod Enable</b> toggle switches turn the corresponding Modulation Generator ON and OFF. Each Modulation Generator is controlled independently and can be configured differently.
<b>Mod Shape</b>	This parameter selects the shape of the modulated waveform that is being applied to the carrier frequency for the specified modulation generator.
<b>Mod Frequency</b>	This field defines the frequency of the signal created by the modulation generator.
<b>Mod FM Deviation</b>	The FM Deviation field is enabled when <b>FM Mod Type</b> is selected. This field defines the frequency by which the modulated waveform varies from the carrier frequency.
<b>Mod PM Deviation</b>	The PM Deviation field is enabled when <b>PM Mod Type</b> is selected. This field defines the degree in radians by which the modulated waveform varies from the carrier frequency.
<b>Mod AM Depth</b>	The AM Depth field is enabled when <b>AM Mod Type</b> is selected. This field defines the percent by which the modulated waveform varies the amplitude of the carrier frequency.
<b>Mod Ext Enable</b>	This control enables or disables the CX300's ability to receive and process a modulated signal received from an external modulation source.
<b>Mod Ext Source</b>	This menu selects the CX300 input connector to which the external modulation source is connected. A modulation source must be connected to the selected input connector to obtain a modulated input signal.

**Table 5-8 Analog Modulation Controls and Settings (Continued)**

<b>Parameter</b>	<b>Description</b>
<b>Mod Ext FM Deviation</b>	The <b>Mod Ext FM Deviation</b> field is enabled when <b>FM Mod Type</b> is selected. This field defines the FM deviation level per Vrms of the modulated signal received from an external modulation source.
<b>Mod Ext PM Deviation</b>	The <b>Mod Ext PM Deviation</b> field is enabled when <b>PM Mod Type</b> is selected. This field defines the PM deviation level per Vrms of the modulated signal received from an external modulation source.
<b>Mod Ext AM Depth</b>	The <b>Mod Ext AM Depth</b> field is enabled when <b>AM Mod Type</b> is selected. This field defines the AM depth per Vrms of the modulated signal received from an external modulation source.



**NOTE**

The test set's modulation generators are utilized for generating tone encoded RF modulated signals. When Modulation Generator is selected as the signal source for tone encoding, Modulation Generators 1 and 2 are not available. [See section 5.10, "Tone Encoding", on page 5-45](#) for information.

### 5.4.2.1 Configuring the Modulation Generator

This section provides instructions to configure the CX300 to output a modulated signal.

**The following information describes information about configuring the RF Generator.**

#### To Configure Modulation Characteristics

1. Navigate to the **Analog Mod** controls and settings.
2. Select desired modulation type from the **Mod Type** menu.
3. Configure modulation parameters (e.g. **Shape**, **Frequency**).
4. Turn the **Mod Enable** toggle switch to Enabled.

#### To Output the Modulated RF Signal

5. Set the RF Generator **Enable** toggle switch to Enabled.
6. The CX300 is now generating a modulated signal.

### 5.4.3 AF Generator

The CX300 contains three Audio Function (AF) generators that are capable of supporting the simultaneous output of three signals of different frequencies, shape, and power. The generated audio signal is output at the test set's AF Output connector. The following controls and settings are used to configure the characteristics of the generated audio signals:

**Table 5-9 AF Generator Controls and Settings**

Parameter	Description
<b>AF Gen Enable</b>	The toggle switches turn the corresponding AF Generator on and off.
<b>AF Gen Shape</b>	This field selects the type of waveform to be generated by the corresponding AF Generator.
<b>AF Gen Frequency</b>	This field defines the frequency of the outgoing waveform. Each function generator can be configured to produce a waveform at a different frequency.
<b>AF Gen Level</b>	This field defines to output level of the signal in either Voltage peak-to-peak ( <b>Vpp</b> ) or Volts Root Mean Square ( <b>Vrms</b> ) as selected in the <b>Level Type</b> field.



**NOTE**

The test set's AF generators are utilized for generating tone encoded audio signals. When Audio Generator is selected as the signal source for tone encoding, Audio Generators 1 and 2 are not available. See section 5.10, "Tone Encoding", on page 5-45 for information.

### 5.4.3.1 Configuring the Audio Function (AF) Generator

This section provides instructions to configure the CX300 to output an audio signal.

***To Configure the AF Generator***

1. Select **Communications Test** mode.
2. Select measurement mode (e.g. **Analog**) and press **Done** button.
3. Press the **Full Test Settings** button (  ) to open the **Full Test Settings** menu.
4. Select the AF Generator **Shape**.
5. Define the AF Generator **Frequency**.
6. Define the AF Generator **Level**.
7. Set the AF Generator **Enable** toggle switch to ON.
8. The CX300 is now generating an audio signal at the AF Output connector.

## 5.5 CX300 Receive Functions

The following procedure describes how the RF Receiver Functions.

### 5.5.1 RF Receiver

The RF Receiver controls and settings are used to determine how the instrument processes an incoming signal. In order to obtain accurate test and measurement results, RF Receiver parameters must be set according to the known characteristics of the incoming signal.

The RF Receiver PORT, frequency, reference level, and external attenuator parameters apply to all types of incoming signals. There are additional parameters that must be configured depending on the type of modulation that has been applied to the incoming signal.

RF Receiver controls and settings are configured from the **RF Receiver settings menu**. Some controls are also accessed from the **Quick Access Toolbar** or **Test Settings Toolbar**. The parameters of the modulation type of the incoming signal are configured on the **Analog Demod settings menu**.



#### **INPUT OVERLOAD**

Do not overload input connectors. Refer to product labeling or product specifications for maximum input ratings.

**Table 5-10 RF Receiver Controls and Settings**

Parameter	Description
<b>Port</b>	<p>The RF Receiver <b>Port</b> selects the input connector at which the incoming signal is being received. This setting should be selected according to the properties of the incoming signal and the requirements of the test being performed.</p> <p><b>RF Input</b></p> <p><b>RF Input</b> should be selected for performing high sensitivity, low power measurements. When <b>RF Input</b> is selected, the RF Receiver’s pre-amplifier is available (see <a href="#">Pre-Amp</a> description on page 23).</p> <p><b>RF Duplex</b></p> <p><b>RF Duplex</b> port should be selected for receiving high power signals. If the input power exceeds the input rating of the RF Duplex connector, an external attenuator or adapter can be used to adjust the input level. When an external attenuator is used, the RF Receiver <b>Attenuation</b> field is used to adjust for the use of the external attenuator.</p>
<b>Receiver Frequency</b>	<p>The RF Receiver <b>Frequency</b> should be set to match the frequency being transmitted by the radio.</p>
<b>Reference Level</b>	<p><b>Reference Level</b> defines the signal level in relation to the RF Input of the incoming signal; the field should be set higher than the expected power level of the incoming signal.</p>
<b>Level Offset</b>	<p>The <b>Level Offset</b> accounts for a loss or gain in the RF path between the CX300’s RF Receiver input connector and the Unit Under Test. The <b>Level Offset</b> field defines the value that is applied to the RF Receiver’s reference level.</p> <ul style="list-style-type: none"> <li>• The offset value is indicated in +dB for positive (gain) values.</li> <li>• The offset value is indicated in -dB for negative (loss) values.</li> </ul>
<b>Intermediate Frequency (IF) Bandwidth (BW)</b>	<p><b>IF BW</b> (IF Bandwidth) selects the IF detection bandwidth. A lower bandwidth reduces the interference caused by powerful narrow band transmitters, therefore, select the IF bandwidth appropriate for the characteristics of the incoming signal.</p>

**Table 5-10 RF Receiver Controls and Settings**

Parameter	Description
<b>Level Control Mode</b>	<p><b>Level Control Mode</b> selects how the CX300 adjusts the level of the incoming signal.</p> <p><b>Manual</b></p> <p>When <b>Manual</b> is selected, the RF Receiver <b>Attenuation</b> and <b>Pre-Amplifier</b> are enabled to allow the user to define how the RF Receiver adjusts for the input level of the incoming signal. <b>Manual</b> would be used in situations in which an external pad or adapter are used in the receive signal path.</p> <p><b>Auto</b></p> <p>When <b>Auto</b> is selected, the CX300 <b>Automatic Gain Control (AGC)</b> function optimizes the attenuation or gain. See Attenuation NOTE below for use case.</p>
<b>Attenuation</b>	<p>This field is enabled when <b>Level Control Mode</b> is set to <b>Manual</b>.</p> <p>The <b>Attenuation</b> field sets the test set's internal attenuation.</p>
	<p><b>NOTE</b></p> <p>Manual attenuation settings are only intended to be used in test cases in which the attenuation of the UUT is known.</p>
<b>Pre-Amp</b>	<p>The RF Receiver's pre-amplifier is enabled when <b>Level Control Mode</b> is set to <b>Manual</b>. This toggle switch determines whether or not the pre-amplifier is included (ON) in the input signal path. The pre-amplifier (<b>PreAmp</b>) is typically used to boost weak incoming signals to eliminate noise and produce a clean signal that is strong enough to be processed.</p>

### 5.5.1.1 Configuring the RF Receiver



#### INPUT OVERLOAD

Do not overload input connectors.

#### *To Configure the RF Receiver - Basic Setup*

1. Select **Communications Test** Mode of operation.
2. Select measurement (e.g. **Analog**) and press the **Done** button.
3. Connect the incoming RF Signal to the RF Receiver Connector appropriate for the characteristics of the incoming signal.
4. Press the **Full Test Settings** button (  ) to open the **Full Test Settings** menu.
5. Select the RF Receiver **Port** to which the RF signal is connected (step 3).
6. Set the RF Receiver **Frequency** to the frequency of the incoming signal.
7. Set the RF Receiver **Reference Level** to the power level of the generator/radio.
8. Select an RF Receiver **IF Bandwidth**.
9. Set **Level Control Mode** to **Auto**.
10. Navigate to the **Analog Demod** settings. Select the **Demod Type** according to the modulation of the incoming signal.



## 5.5.2 Audio In

Audio In settings are used to configure how the test set processes incoming audio signals. The Audio In pane contains the following settings:

**Table 5-11 Audio In Controls and Settings**

Parameter	Description
<b>Source</b>	<p>The <b>Source</b> setting selects the input connector used to receive incoming audio signals.</p> <p><b>AF Input 1</b>            Selects the high power audio input connector. This connector should be used for receiving high power signals.</p> <p><b>AF Input 2</b>            Selects the low power audio input connector. This connector should be used for receiving low power signals and for performing high sensitivity measurements.</p> <p><b>Balanced</b>            Sets the Audio 1 and Audio 2 Connectors to accept a balanced differential input audio signal. The balanced input has an impedance of 600 <math>\Omega</math>.</p> <p><b>MIC/ACC</b>            Selects the <b>MIC/ACC</b> connector as the audio source. When this source is selected, an audio source must be received at the connector in order to obtain audio measurements.</p> <p><b>FGEN Loop back</b>            When <b>FGEN Loop back</b> is selected the CX300 uses the internal AF Generator signal as the Audio In signal source.</p>

**Table 5-11 Audio In Controls and Settings (Continued)**

<b>Parameter</b>	<b>Description</b>
<b>Psophometric Filter</b>	<p>Psophometric filters are typically used when measuring the residual noise in audio equipment. The Psophometric filter is included in the signal path to emphasize the audible parts of the signal and attenuate signal components that contribute less to perception of loudness.</p> <p>CCITT and C-message (C-MSG) weighting filters are bandpass filters used to measure audio-frequency noise on telephone circuits.</p> <p><b>None</b></p> <p>No filter is included in the signal path.</p> <p><b>C-MSG Filter</b></p> <p>The C-MSG is used for voice, audio, and telecommunication applications in the U.S.</p> <p><b>CCITT</b></p> <p>The CCITT (ITU-T) filter is used for international telephone circuits.</p>
<b>High Pass Filter</b>	<p>A high-pass filter (HPF) passes signals with a frequency higher than a selected cutoff frequency.</p> <p>Not applicable to Psophometric filter type.</p>
<b>Low Pass Filter</b>	<p>A low-pass filter (LPF) passes signals with a frequency lower than a selected cutoff frequency.</p> <p>Not applicable to Psophometric filter type.</p>
<b>Audio 1 Impedance</b>	<p>Selects the input impedance of the <b>Audio In</b> connector to a value that matches the output impedance of the audio source.</p>

**Table 5-11 Audio In Controls and Settings (Continued)**

Parameter	Description
<b>Range</b>	Selects the valid voltage input permitted on the audio input connector. Input voltage exceeding the range setting is clipped and not included in the measurement.
<b>Coupling</b>	<p>Selects how AC/DC signal components are filtered from the received signal.</p> <p><b>AC Coupling</b></p> <p>AC coupling filters the DC signal component out of a signal that contains both AC and DC components. The DC component of a signal acts as a voltage offset so removing the component may increase the resolution of signal measurements.</p> <p><b>DC Coupling</b></p> <p>DC coupling does not filter components from the signal; both AC and DC signal components are therefore present in the signal. DC coupling is typically used when any offset voltage present is <math>&lt;\pm 100</math> mV or if the DC content of the signal is important.</p>

## 5.6 CX300 Meters

The CX300 supports a variety of meters that can be used to evaluate the transmit and receive performance of the Unit Under Test (UUT). The types of meters that are displayed in the Meter pane depend on the following:

- Measurement Test Mode currently selected (**Duplex Test**, **Transmitter Test** or **Receiver Test**).
- Modulation type selected from the Analog **Demodulation Type** menu (see "[Demod Type](#)" on page 5-33).
- User selections such as the type of noise measurement, or the type of power measurement to be performed.

This section provides a description of the meters the user will encounter when using **Transmitter Test**, **Duplex Test**, and **Receiver Test** modes of operation.

### 5.6.1 Meter Limits

Meter limits are used to define pass/fail criteria for measurements. CX300 meters support upper and lower limits as appropriate for each measurement. When limits are enabled for a meter, visual indicators are provided that indicate enabled limits, limit settings, and measurement pass/fail status. [Table 5-12 on page 5-28](#) and [Figure 5-6 on page 5-30](#) provide information and descriptions of the various indicators a user may encounter when using meter limits.

### 5.6.1.1 Lower Limits

The **Lower Limit** field sets a minimum acceptable reading for a specific measurement. When a measurement falls below the enabled lower limit value, the meter scale changes to blue.

When readings are above a defined lower limit, or within enabled upper and lower limits, the meter scale changes to green.

### 5.6.1.2 Upper Limits

The **Upper Limit** field sets a maximum acceptable reading for a specific measurement. When a measurement exceeds the enabled upper limit value, the meter scale changes to red.

When readings are below a defined upper limit, or within enabled upper and lower limits, the meter scale changes to green.

### 5.6.1.3 Limit Indicators

The following are visual indicators a user will encounter when using meter limits:

**Table 5-12 UI Limit Indicators**

Indicator	Description
<b>Limit Check Indicators</b>	When upper and lower limit values are defined for a meter, and the limit settings may be invalid, the limit controls on the UI update to yellow and an alert symbol is displayed next to the limit controls. The limit check indicators serve as visual indicators that the limit settings may be invalid (i.e. the lower limit value is set to a limit greater than the upper limit value, or vice-versa).



**Figure 5-5 Limit Check Indicators - Example of Invalid State**

<b>Pass/Fail Text Indicators</b>	Pass/fail indicators are displayed in the meter reading pane and in the Title Bar to provide visual indicators of measurement pass/fail status.
----------------------------------	---

**Table 5-12 UI Limit Indicators (Continued)**

<b>Indicator</b>	<b>Description</b>
<b>Meter Scale Indicators</b>	<p>When limits are enabled, the color of the meter scale updates to indicate enabled limits and to provide a visual indicator of the limit setting.</p> <ul style="list-style-type: none"><li>• Blue for lower limit</li><li>• Red for upper limit</li><li>• Green to indicate the measurement range between upper and lower limits.</li></ul>
<b>Measurement Bar</b>	<p>When limits are enabled, the measurement bar is color coded to indicate pass/fail status.</p> <ul style="list-style-type: none"><li>• Blue indicates the measurement is below the lower limit</li><li>• Red indicates the measurement is above the upper limit</li><li>• Green indicates the measurement passes defined limits</li></ul>

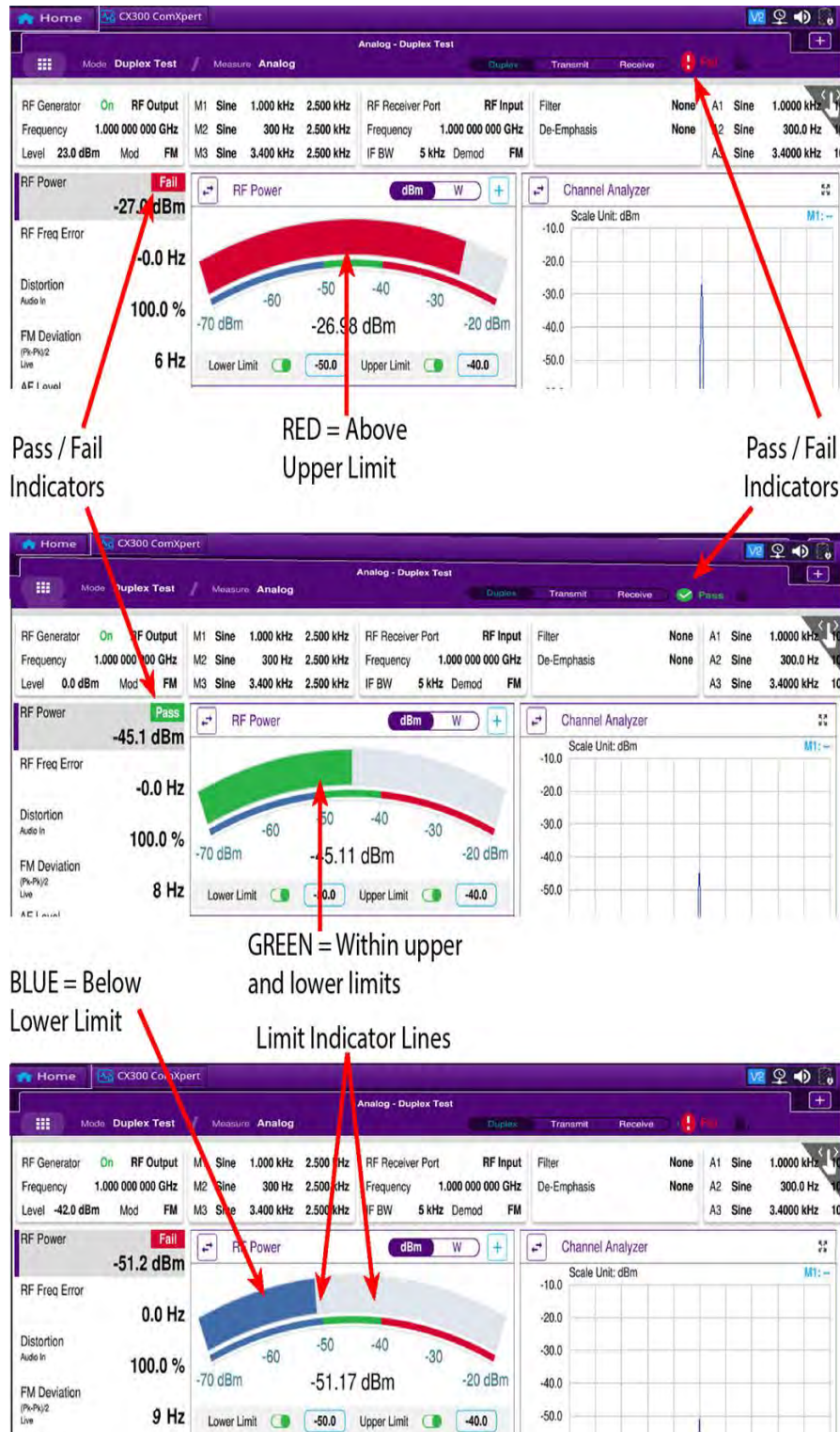

Figure 5-6 Limit Check Indicators

## 5.6.2 Meter Scale Settings

The upper and lower settings of a meter's scale can be defined by the user. The following methods are supported to define a meter's scale settings:

- Pre-Defined
  - The user can select from a pre-defined list of values which are appropriate for the measurement. The selected value defines the upper scale value; the lower value defaults to a value appropriate for the measurement.
- Custom
  - **Custom** allows the user to define the upper and lower scale settings. When **Custom** is selected, the upper and lower scale fields update to editable data fields. Selecting the upper and lower scale field displays the **Numeric Keypad** which allows you to enter an arbitrary value.
- Auto
  - When **Auto** is selected, the system adjusts the scale to settings best suited to the characteristics of the received signal.

## 5.6.3 Average Measurements

When appropriate for the measurement type, CX300 measurement meters support average measurements. The **Avg Samples** field is used to define the number of samples that are used to calculate average measurements. Average is calculated as a rolling average.

## 5.6.4 Refresh Meters

Meter readings are refreshed using the **Refresh button** (  ). The following are examples of when meters should be refreshed:

- When limits have been triggered and a new measurement is started.
- To restart average measurement calculations.
- When test parameters have been changed.

## 5.6.5 Analog Demodulation (Meter)

The CX300 Analog Demodulation controls and settings are used to configure the device's RF Receiver to demodulate AM, FM, PM, and SSB analog-modulated signals. The resulting analog modulation measurements can be used to evaluate modulation performance characteristics such as modulation accuracy and to identify any distortion present on the signal.

### Modulation Meters

- **AM Depth Meter**

The Amplitude Modulation (AM) Depth meter displays the percentage of modulation of an amplitude modulated signal. The AM Depth meter is displayed when the Analog **Demodulation Type** is set to **AM** (see [Table 5-13 on page 5-33](#)).

- **FM Deviation Meter**

The Frequency Modulation (FM) Deviation meter displays the amount of frequency by which the carrier deviates from center frequency on a frequency modulated signal. The FM Deviation meter is displayed when the Analog **Demodulation Type** is set to **FM** (see [Table 5-13 on page 5-33](#)).

- **PM Deviation Meter**

The Phase Modulation (PM) Deviation meter displays the degree by which the carrier deviates from center frequency on a phase modulated signal. The Phase Modulation (PM) meter is displayed when the Analog **Demodulation Type** is set to **PM** (see [Table 5-13 on page 5-33](#)).

- **SSB Depth Meter**

The Single Sideband (SSB) Depth meter displays the percentage of modulation of an SSB modulated signal. The SSB Depth meter is displayed when the Analog **Demodulation Type** is set to **SSB** (see [Table 5-13 on page 5-33](#)).



The CX300 supports the following Analog Demodulation controls and settings:

**Table 5-13 Analog Demodulation Controls and Settings**

Parameter	Description
<b>Demod Type</b>	<p>Selects the type of modulation that has been applied to the incoming signal, enabling the corresponding meter and providing controls and parameters necessary to separate the data from the carrier wave.</p> <p>The demodulation controls and parameters that are available are determined by the following:</p> <ul style="list-style-type: none"> <li>• The type of signal that is being demodulated</li> <li>• The type of AF Filter (Audio Filter) that is selected</li> <li>• The selected filter characteristics (when applicable)</li> <li>• The De-Emphasis setting (when applicable)</li> </ul>
<b>Mod Level Type</b>	<p>This setting selects the type of measurement displayed on the Analog Demod meter.</p> <p><b>Live</b></p> <p>When <b>Live</b> is selected, the meter displays the measured value of the signal at that given point in time. The meter updates continuously as long as the device is receiving an incoming signal.</p> <p><b>Average</b></p> <p>When <b>Average</b> is selected, the <b>Average</b> field is used to define the number of readings acquired to calculate the average measurement. The meter reading updates when the defined number of measurements has been processed.</p> <p><b>Maximum</b></p> <p>When <b>Max</b> is selected, the meter displays the highest reading detected at that point in time. The meter updates when/if a reading is detected that is higher than the currently displayed measurement.</p> <p><b>Minimum</b></p> <p>When <b>Min</b> is selected, the meter displays the lowest reading detected at that point in time. The meter updates when/if a reading is detected that is lower than the currently displayed measurement.</p>

**Table 5-13 Analog Demodulation Controls and Settings (Continued)**

<b>Parameter</b>	<b>Description</b>
<b>Psophometric Filter</b>	<p>Psophometric filters are typically used when measuring the residual noise in audio equipment. The Psophometric filter is included in the signal path to emphasize the audible parts of the signal and attenuate signal components that contribute less to perception of loudness.</p> <p>CCITT and C-message (C-MSG) weighting filters are bandpass filters used to measure audio-frequency noise on telephone circuits.</p> <p><b>None</b></p> <p>No filter is included.</p> <p><b>C-MSG Filter</b></p> <p>The C-MSG is used for voice, audio, and telecommunication applications in the U.S.</p> <p><b>CCITT</b></p> <p>The CCITT (ITU-T) filter is used for international telephone circuits.</p>
<b>High Pass Filter</b>	A high-pass filter (HPF) passes signals with a frequency higher than a selected cutoff frequency.
<b>Low Pass Filter</b>	A low-pass filter (LPF) passes signals with a frequency lower than a selected cutoff frequency.
<b>De-Emphasis Filter</b>	<p>This setting only applies to FM Demodulated Signals.</p> <p>These processes of boosting high frequencies before transmission, then reducing the frequencies at the receiver to reduce noise on high frequencies, are known as pre-emphasis and de-emphasis.</p> <p>The De-Emphasis filter must match the pre-emphasis value applied at the transmitter in order to obtain accurate measurements.</p>

## 5.6.6 RF Power Measurements

The RF Power meter is used to evaluate the RF transmit performance of a UUT, most commonly to determine if the UUT's output power is meeting specification.

The RF Power meter supports limits which are described in [section 5.6.1, on page 5-27](#), user-configurable meter scales which are described in [section 5.6.2, on page 5-31](#), and average measurements which are described in [section 5.6.3, on page 5-31](#).

The RF Power meter also contains the following controls and settings:

**Table 5-14 RF Power Meter Controls and Settings**

Parameter	Description
Unit	Selects the unit-of-measurement used to display the RF Power reading.

## 5.6.7 Transmitter Frequency Measurements

The CX300 provides users with the ability to choose between either RF Error meter or RF Counter for evaluating RF signal accuracy. The type of measurement is selected using the **Frequency Measurement toggle switch** located on the RF Error meter pane.



This switch is accessed from the RF Error/RF Counter meter pane.

The Frequency Measurement toggle switch selects either the RF Error meter or the RF Counter as the active radio frequency measurement.

When **Error** is selected, the measurement pane updates to display a Frequency Over Time plot field which provides a visual representation of the measurement.

### 5.6.7.1 RF Error Meter

The RF Error meter measures the frequency error of the received signal in relation to the defined RF Receiver **Frequency**. RF Error controls and settings are accessed from the **RF Freq Error settings menu**.

The RF Error meter supports limits which are described in [section 5.6.1, on page 5-27](#), user-configurable meter scales which are described in [section 5.6.2, on page 5-31](#), and average measurements which are described in [section 5.6.3, on page 5-31](#).

- A positive error indicates that the transmitter signal's frequency is too high.
- A negative error indicates that the transmitter signal's frequency is too low.

### 5.6.7.2 RF Counter

The RF Counter displays the frequency of the received RF Signal. The RF Counter is used to perform tasks such as measuring the frequency of a carrier signal or measuring the frequency accuracy of the incoming RF signal.

RF Counter controls and settings are accessed from the **RF Freq Error settings menu**. The RF Counter supports limits which are described in [section 5.6.1, on page 5-27](#), user-configurable meter scales which are described in [section 5.6.2, on page 5-31](#), and average measurements which are described in [section 5.6.3, on page 5-31](#).

### 5.6.8 Demod Noise Meters

The CX300 supports SINAD, Signal-to-Noise Ratio (SNR) and Distortion noise measurements. The type of noise measurement to be performed is selected from the **Type menu**.

- Demod Noise meter controls and settings are accessed from the **Noise (Demod) settings menu**.
- Demod Noise meter signal routing is configured on the Audio Controls window (see [See section 5.7, “Audio Controls and Signal Routing”, on page 5-42](#)).

#### 5.6.8.1 Demod SINAD Meter

SINAD measurements are typically used to determine receiver sensitivity, but they can also be used to determine how a transmit signal is degraded by noise and distortion. The SINAD meter displays the ratio Signal + Noise + Distortion divided by the sum of Noise + Distortion, the result of which is displayed in dB.

The SINAD meter supports limits which are described in [section 5.6.1, on page 5-27](#), user-configurable meter scales which are described in [section 5.6.2, on page 5-31](#), and average measurements which are described in [section 5.6.3, on page 5-31](#). The SINAD meter also contains the following controls and settings:

**Table 5-15 Demod SINAD Meter Controls and Settings**

Parameter	Description
<b>Notch BW</b>	This field sets the notch filter bandwidth used when performing noise measurements.
<b>Notch Frequency</b>	This field defines the frequency that is being measured when performing noise measurements.

### 5.6.8.2 Demod Distortion Meter

The Distortion meter is used to detect and isolate any frequencies that are causing distortion on the incoming RF signal. The distortion meter displays the difference between the incoming modulation and an ideal sine wave. The differences detected are a result of extraneous signals present in the RF signal (i.e. noise, external signals).

The Distortion meter supports limits which are described in [section 5.6.1, on page 5-27](#), user-configurable meter scales which are described in [section 5.6.2, on page 5-31](#), and average measurements which are described in [section 5.6.3, on page 5-31](#). The Distortion meter also contains the following controls and settings:

**Table 5-16 Demod Distortion Meter Controls and Settings**

Parameter	Description
Notch BW	This field sets the notch filter bandwidth used when performing noise measurements.
Notch Frequency	This field defines the frequency that is being measured when performing noise measurements.

### 5.6.8.3 Demod Signal to Noise Meter

Signal-to-noise (SNR) is a measurement that compares the level of a desired signal to the level of background noise. SNR is used to evaluate the receive performance of the Unit Under Test (UUT) by identifying how well signal frequency components stand out from noise interference in the signal.

The SNR meter supports limits which are described in [section 5.6.1, on page 5-27](#), user-configurable meter scales which are described in [section 5.6.2, on page 5-31](#), and average measurements which are described in [section 5.6.3, on page 5-31](#). The SNR meter also contains the following controls and settings:

**Table 5-17 Demod SNR Meter Controls and Settings**

Parameter	Description
Type	Selects the type of SNR measurement to be performed. This setting is enabled when SNR noise measurement is selected.
<b>Hum &amp; Noise</b>	<b>The Demod SNR Hum &amp; Noise reading measures the transmitter of the radio under test. SNR Hum &amp; Noise is a measurement of the level of the audio signal that is demodulated by the test set when the radio sends a modulated signal, versus when the signal is not modulated.</b>

**Table 5-17 Demod SNR Meter Controls and Settings**

Parameter	Description
Type (cont)	<p><b>Normal</b></p> <p>When the Normal Demod SNR meter is selected, the test set transmits an audio signal to a radio under test in an ON/OFF cycle. The internal signal of the radio under test is modulated with the audio signal it receives from the test set. The radio under test then sends this modulated signal back to the test set. The test set receives and demodulates the signal received from the radio under test. The SNR reading is the ratio of the level of the demodulated audio signal when the Modulation Generator is ON versus the level when the Modulation Generator is OFF.</p>
<b>Notch BW</b>	This field sets the notch filter bandwidth used when performing Hum & Noise SNR Measurements.
<b>Notch Frequency</b>	This field defines the frequency that is being measured when performing noise measurements.
<b>Notch Enable</b>	Selects whether or not a notch filter is used for performing Hum and Noise & SNR Measurements. When Hum & Noise SNR Notch Filter Mode is enabled, the notch filter removes the sub audible CTCSS or CDCSS tone.

### 5.6.9 Audio Noise Meters

The CX300 supports SINAD, Signal to Noise (SNR) and Distortion noise measurements. The type of noise measurement to be performed is selected from the **Type menu**.

#### **To Configure Audio Noise Meters**

Audio Noise meter controls and settings are accessed from the **Noise (Audio) settings menu**.

Audio Noise meter signal routing is configured on the Audio Controls Window (see [See section 5.7, “Audio Controls and Signal Routing”, on page 5-42](#)).

### 5.6.9.1 Audio SINAD Meter

SINAD measurements are typically used to determine receiver sensitivity, but they can also be used to determine how a transmit signal is degraded by noise and distortion. The SINAD meter displays the ratio Signal + Noise + Distortion divided by the sum of Noise + Distortion, the result of which is displayed in dB.

The SINAD meter supports limits which are described in [section 5.6.1, on page 5-27](#), user-configurable meter scales which are described in [section 5.6.2, on page 5-31](#), and average measurements which are described in [section 5.6.3, on page 5-31](#). The SINAD meter also contains the following controls and settings:

**Table 5-18 Audio SINAD Meter Controls and Settings**

Parameter	Description
Notch BW	This field sets the notch filter bandwidth that is used when performing noise measurements.
Notch Frequency	This field defines the frequency that is being measured when performing noise measurements.

### 5.6.9.2 Audio Distortion Meter

The Distortion meter is used to detect and isolate any frequencies that are causing distortion on the incoming audio signal. The Distortion meter displays the difference between the incoming audio signal in relation to the signal generated by the CX300. The differences detected are a result of extraneous signals present in the audio signal (i.e., noise, external signals).

The Distortion meter supports limits which are described in [section 5.6.1, on page 5-27](#) and user-configurable meter scales which are described in [section 5.6.2, on page 5-31](#). The Distortion meter also contains the following controls and settings:

**Table 5-19 Audio Distortion Meter Controls and Settings**

Parameter	Description
Notch BW	This field sets the notch filter bandwidth used when performing noise measurements.
Notch Frequency	This field defines the frequency that is being measured when performing noise measurements.

### 5.6.9.3 Audio Signal to Noise Ratio Meter

Signal-to-Noise Ratio (SNR) is a measurement that compares the level of a desired signal to the level of background noise. SNR is used to evaluate the receive performance of the Unit Under Test (UUT) by identifying how well signal frequency components stand out from noise interference in the signal.

supports limits which are described in [section 5.6.1, on page 5-27](#) and user-configurable meter scales which are described in [section 5.6.2, on page 5-31](#). The SNR meter also contains the following controls and settings:

**Table 5-20 Demod SNR Meter Controls and Settings**

Parameter	Description
<b>Type</b>	<p>Selects the type of SNR measurement to be performed.</p> <p><b>Hum &amp; Noise</b></p> <p>The Audio SNR Hum &amp; Noise reading measures the receiver of the radio under test. Audio SNR Hum &amp; Noise is a measurement of the level of the audio signal that is demodulated by the radio when the test set sends a modulated signal versus when the signal is not modulated.</p> <p><b>Normal</b></p> <p>When the Normal Audio SNR meter is selected the test set transmits a user defined, modulated RF signal to a radio under test. The test set transmits the signal, cycling the modulation ON and OFF while the signal is being transmitted. The radio under test demodulates the signal it receives from the test set and sends an audio signal back to the test set (via the Audio In connectors). The SNR reading is the ratio of the level of the audio in the modulated signal versus the level of audio in the demodulated signal.</p>
<b>Notch BW</b>	This field sets the notch filter bandwidth used when performing Hum & Noise SNR Measurements.
<b>Notch Frequency</b>	This field defines the frequency that is being measured when performing noise measurements.
<b>Notch Enable</b>	Selects whether or not a notch filter is used for performing Hum and Noise & SNR Measurements. When <b>Hum &amp; Noise SNR Notch Filter Mode</b> is enabled, the notch filter removes the sub audible CTCSS or CDCSS tone.



## 5.6.10 AF Level Meter

The AF Level meter indicates the amplitude of the received audio signal. The measurement is used to evaluate the output power performance of the transmit device.

AF Level controls and settings are configured from the **AF Level settings menu**. The AF Level meter supports limits which are described in [section 5.6.1, on page 5-27](#), user-configurable meter scales which are described in [section 5.6.2, on page 5-31](#), and average measurements which are described in [section 5.6.3, on page 5-31](#).

## 5.6.11 AF Counters

AF Counter is a dynamic meter that changes according to the selected input source.

- When **Audio In** is selected, the AF Counter updates to display the AF Audio Counter.
- When **Demod** is selected, the AF Counter updates to display the AF Demod Counter.

AF Counter input source is selected on the Audio In window. [See section 5.5.2, “Audio In”, on page 5-25](#).

### 5.6.11.1 AF Counter (Demod)

The AF Demod Counter displays the frequency of the modulation on the received RF signal. The AF Demod Counter is used to measure the frequency accuracy of the incoming signal.

The AF Demod Counter supports limits which are described in [section 5.6.1, on page 5-27](#), user-configurable meter scales which are described in [section 5.6.2, on page 5-31](#), and average measurements which are described in [section 5.6.3, on page 5-31](#).

### 5.6.11.2 AF Counter (Audio)

The AF Audio Counter displays the frequency of the audio signal received at the selected audio input connector. [See section 5.5.2, “Audio In”, on page 5-25](#).

The AF Audio Counter supports limits which are described in [section 5.6.1, on page 5-27](#), user-configurable meter scales which are described in [section 5.6.2, on page 5-31](#), and average measurements which are described in [section 5.6.3, on page 5-31](#).

## 5.7 Audio Controls and Signal Routing

The test set's audio signal routing, volume and squelch settings are configured on the Audio Controls window. The Audio Controls window is used to configure settings such as speaker routing, the signal source for performing noise measurements, and the Oscilloscope input signal.

The Audio Controls window is displayed by selecting the **Audio Controls button** from the **Quick Access Toolbar** (see [Table 5-2](#)). The **Audio Controls** window contains the following controls and settings:

**Table 5-21 Audio Controls and Settings**

Control/Setting	Description
<b>Audio Volume</b>	The audio slider bar adjusts the volume of the speaker's audio.
	The <b>Audio Control button</b> is used to mute/un-mute the audio signal.
<b>Audio Squelch</b>	The squelch slider bar is used to adjust the audio squelch level. Squelch adjusts the threshold above which the CX300 receiver recognizes a signal and starts measurements.

**Table 5-22 Audio Signal Routing Controls and Settings**

Control/Setting	Description
<b>Signal Routing</b>	This control selects the signal source used by the Speaker, Oscilloscope, Noise meters or AF Frequency Counter. <b>Audio</b> When <b>Audio</b> is selected, the test set function uses the signal being received at the audio input connector as the signal source. Audio Input is selected in the Audio In pane. <a href="#">See section 5.5.2, "Audio In", on page 5-25.</a>
	<b>Demod</b> When <b>Demod</b> is selected, the test set function uses the signal being received at the RF input connector as the signal source. The RF input source is selected in the RF Receiver pane. <a href="#">See section 5.5.1, "RF Receiver", on page 5-21.</a>
	<b>AF Gen</b> When <b>AF Gen</b> is selected the test set routes the signal being generated by the test set's internal AF Generator to the speaker.

**Table 5-22 Audio Signal Routing Controls and Settings**

Control/Setting	Description
Signal Routing (cont)	
<b>Speaker</b>	This control selects the source of the signal being received by the speaker.
<b>Oscilloscope</b>	This control selects the source of the signal being received by the Oscilloscope.
<b>Noise</b>	This control selects the source of the signal being used to perform noise measurements.
<b>AF Freq Counter</b>	This control selects the source of the signal used by the AF Frequency Counter.

## 5.8 DVM (Digital Voltmeter)

The Digital Voltmeter (DVM) measures the electrical potential difference between two points in a circuit, either Direct Current Voltage (VDC) or Alternating Current Voltage (VAC). The DVM meter displays the results of this measurement. The **AF Input 1 connector** or **AF Input 2 connector** can be selected as the input connector used for performing DVM measurements.

The DVM meter pane contains a plot field that displays measurement as voltage (vertical scale) over time (horizontal scale). DVM controls and settings are configured from the **DVM settings menu**. The DVM supports user-configurable meter scales which are described in [section 5.6.2, on page 5-31](#). The DVM also contains the following controls and settings:

**Table 5-23 DVM Controls and Settings**

Parameter	Description
<b>Measurement Peak</b>	This setting selects the type of measurement being displayed on the meter. <b>Positive Peak</b> When <b>Positive Peak</b> is selected, the meter displays the highest positive value measured.
	<b>Negative Peak</b> When <b>Negative Peak</b> is selected, the meter displays the lowest negative value measured.

**Table 5-23 DVM Controls and Settings (Continued)**

Parameter	Description
Measurement Peak (cont)	
	<p><b>RMS</b></p> <p>When <b>RMS</b> is selected, the meter displays the Root-Mean-Squared (RMS) value. RMS is the square root of the (average) value of the squared function of the instantaneous values.</p>
	<p><b>Mean</b></p> <p>When <b>Mean</b> is selected, the meter displays the average voltage value. The number of measurements used to calculate the mean is defined in the <b>Average</b> field.</p>

## 5.9 Tone Decoding

Tone Decoding provides users with the ability to decode received audio and modulated signals. The Tone Decoding pane is viewed on the Measurement Pane (See Table 5-2).

**Table 5-24 Tone Decoding Controls and Settings**

Parameter	Description
<b>Decode Type</b>	The type of tone to be decoded is selected from the Type drop-down menu. The type of generator is selected from the Generator drop-down menu. Available parameters update according to the type of tone selected.
<b>Source</b>	Selects the source of the encoded signal.
<b>DCS Mode</b>	<p>This parameter applies to <b>DCS Decode Type</b>.</p> <p><b>Normal</b></p> <p>When <b>Normal</b> is selected, DCS is encoded using a positive polarity.</p> <p><b>Inverted</b></p> <p>When <b>Inverted</b> is selected, DCS is encoded using a negative polarity.</p>
<b>Tone Sequence Protocol</b>	<p>This parameter applies to <b>Tone Sequential Decode Type</b>.</p> <p>This setting selects the type of protocol that is expected in the received Tone Sequential signal.</p>
<b>Clear</b>	Clears decoded data from Tone Decode screen.

## 5.10 Tone Encoding

Tone Encoding provides users with the ability to test the performance of tone-activated pagers and control systems. The Tone Encoding pane selected on the Measurement Pane (See Table 5-2 for Measurement Pane).

### 5.10.1 Encoding Type

The type of encoding selected from the **Encoding Type** menu determines the controls and settings that are displayed on the **Tone Encoding window**. The CX300 supports the following types of tone encoding:

- Dual-Tone Multi-Frequency (**DTMF**) (see “[Tone Encoding - DTMF](#)”)
- Digital Coded Squelch (**DCS**) (see “[Tone Encoding - DCS](#)”)
- Continuous Tone-Coded Squelch (**CTCSS**) (see “[Tone Encoding - CTCSS](#)”)
- **Tone Remote** (see “[Tone Encoding - Tone Remote](#)”)
- **Tone Sequential** (see “[Tone Encoding - Tone Sequential](#)”)
- **Two Tone Sequential** (see “[Tone Encoding - Two Tone Sequential](#)”)

### 5.10.2 Tone Encoding Source

The CX300 supports audio and modulated signal encoding. The **Source** field selects whether or not the CX300 applies tone encoding to an outgoing audio signal or modulated signal. The encoded signal is applied to the signal generated by the test set’s modulation or audio generators. When a tone type is selected that contains multiple tones, the test set disables the generator used for each tone.

**Table 5-25 Tone Encoding Menus**

#### Modulation Generator

"Modulation Generator 2 is used for generating all single tone signals. When DTMF is generated, both Modulation Generator 2 and Modulation Generator 3 are used to generate dual tones.

When modulation generators are selected, tone encoding is applied to the signal generated by the test set’s modulation generator and transmitted out of the selected RF Output connector (RF Output or RF Duplex).

Modulation Tone Encoding controls and settings are accessed from the **Tone Encoding window** or from the **Tone Encoding (Demod) settings menu**.

#### Audio Generator

When **Audio Gen** is selected, the tone encoding is applied to the signal generated by the test set’s audio generator and transmitted out of the AF Output connector.

Audio Tone Encoding controls and settings are accessed from the **Tone Encoding window** or from the **Tone Encoding (Audio) settings menu**.

### 5.10.3 Tone Encoding - DTMF

Dual-Tone Multi-Frequency (DTMF) is a tone composed of two sine waves of given frequencies. DTMF is widely used for telecommunication signaling between telephone handsets and switching centers over analog telephone lines in voice-frequency bands. DTMF signal definition includes strict limits for timing (minimum duration and inter-digit spacing), frequency deviations, harmonics, and amplitude relation of the two components with respect to each other.

**Table 5-26 Tone Encoding DTMF Controls and Settings**

Parameter	Description
<b>DTMF Mode</b>	<p>A DTMF code consists of two user 1 and 2 simultaneous frequencies mixed together. The higher of the two frequencies may have higher amplitude; this is referred to as a twist. If the twist is equal to 3 dB, the higher frequency is 3 dB louder. If the lower frequency is louder, the twist is negative.</p> <p><b>Twist</b></p> <p>When <b>Twist</b> is selected, one of the frequencies will have a higher amplitude than the other.</p> <ul style="list-style-type: none"> <li>• Positive twist = higher frequency will be louder</li> <li>• Negative twist = lower frequency will be louder</li> </ul> <p><b>Normal</b></p> <p>When <b>Normal</b> is selected, both frequencies are transmitted at the same volume.</p>
<b>DTMF State</b>	<p>State selects how DTMF pulses are sent.</p> <p><b>Off</b></p> <p>DMTF Encoding is OFF.</p> <p><b>Continuous</b></p> <p>In continuous DTMF mode, the digits/symbols in the DTMF Sequence field are generated continuously.</p>
<b>DTMF State (cont)</b>	<p><b>Burst</b></p> <p>In the burst DTMF mode, the digits/symbols in the DTMF Sequence field are generated once each time the Start button is pressed.</p> <p><b>Live</b></p> <p>When <b>Live</b> is selected, and when the DTMF Sequence field is selected, a keypad is displayed on the UI to manually enter tones. Each time a digit/symbol is entered into the keypad, that digit/symbol is generated.</p>

**Table 5-26 Tone Encoding DTMF Controls and Settings (Continued)**

Parameter	Description
<b>DTMF Sequence</b>	The <b>Sequence</b> field defines/indicates the DTMF sequence of the DTMF waveform.
<b>DTMF High Tone Level</b>	This field defines the output level used for the higher of the two sine waves used in the DTMF tone.
<b>DTMF Low Tone Level</b>	This field defines the output level used for the lower of the two sine waves used in the DTMF tone.
<b>DTMF Mark Duration</b>	This field defines the length of time a tone is emitted.
<b>DTMF Space Duration</b>	This field defines the length of time between tones.
<b>DTMF Pause Duration</b>	This field defines the pause between tones in the encoded signal.

#### 5.10.4 Tone Encoding - DCS

Digital Code Squelch (DCS) is digital data or a code word that is transmitted with voice audio and decoded by the receiver.

**Table 5-27 Tone Encoding DCS Controls and Settings**

Parameter	Description
<b>DCS State</b>	<p>This setting selects how the data or code word is encoded in the audio signal. DCS coded signals are transmitted and received in non-return to zero (NRZ) format, therefore polarity is important.</p> <p><b>Off</b></p> <p>Disables tone encoding.</p> <p><b>Normal</b></p> <p>When <b>Normal</b> is selected, DCS is encoded using a positive polarity.</p> <p><b>Inverted</b></p> <p>When <b>Inverted</b> is selected, DCS is encoded using a negative polarity.</p>
<b>DCS Code</b>	The field defines/indicates the DCS codeword of the generated signal.
<b>DCS Level</b>	This field defines the level of the encoded tone; CTCSS encoder levels are usually set for 15% of system deviation.

### 5.10.5 Tone Encoding - CTCSS

Continuous Tone-Coded Squelch (CTCSS) is a system where a continuous, sub-audible tone is encoded into the transmit audio of a radio to control the squelch opening of a receiver. The receiver will only decode the signal when it receives that specific tone. The CX300 supports the following CTCSS settings.

**Table 5-28 Tone Encoding CTCSS Controls and Settings**

Parameter	Description
<b>CTCSS Tone</b>	This field defines the audio tone that is applied to the carrier signal.
<b>CTCSS Level</b>	This field defines the level of the encoded tone; CTCSS encoder levels are usually set for 15% of system deviation.

### 5.10.6 Tone Encoding - Tone Remote

Tone Remote signaling generates three independent tone sequences that the CX300 uses for Tone Remote Encoding. The ability to define three separate components provides users with the ability to determine if the UUT is properly processing the received audio tone remote sequences.

**Table 5-29 Tone Encoding Remote Controls and Settings**

Parameter	Description
<b>Tone Remote Level</b>	Tone remote levels are relative to a fixed level of one portion of the signal. This field defines the fixed level of the encoded signal.
<b>Tone Frequency</b>	This field defines the modulation frequency for each Tone Remote component.
<b>Tone Level</b>	This field defines signal Level for each Tone Remote component.
<b>Tone Duration</b>	This field defines the length of time each Tone Remote component is emitted.
<b>Start Button</b>	This button begins sending the defined tone sequence.



### 5.10.7 Tone Encoding - Tone Sequential

Tone Sequential signaling allows the user to select a tone sequence protocol and a tone sequence code to emit. This functionality provides the user with ability to determine if the UUT is properly processing the received sequential tone sequence.

**Table 5-30 Tone Encoding Tone Sequential Controls and Settings**

Parameter	Description
<b>Tone Seq Protocol</b>	This menu selects the type of protocol used in the encoded signal.
<b>Tone Sequence</b>	This field defines the code sequence emitted by the test set.
<b>Tone Seq Call Delay</b>	This field defines how long the Modulation Generator extends the first tone in the tone sequence.
<b>Tone Seq Pause</b>	This field defines how long the Modulation Generator pauses before sending the first tone.
<b>Tone Seq Freq Shift</b>	This field defines the frequency shift applied to the frequency of tones transmitted by the Modulation Generator.
<b>Tone Seq Level</b>	This field defines the level for each tone component.
<b>Start Button</b>	This button begins sending the defined tone sequence.

### 5.10.8 Tone Encoding - Two Tone Sequential

Two Tone Sequential signaling allows the user to configure the CX300 to generate two tones at a specified frequency for a defined length of time. The ability to define different tones allows the user to determine if the UUT is properly processing the received audio tone sequence.

**Table 5-31 Tone Encoding Two Tone Sequential Controls and Settings**

Parameter	Description
<b>Two-Tone Level</b>	This field defines the deviation value for each tone.
<b>Space Duration</b>	This field defines the length of time between each tone.
<b>Tone Frequency</b>	This field defines the Tone 1 and Tone 2 frequency for the generator.
<b>Tone Duration</b>	This field defines the length of time Tone 1 and Tone 2 are emitted.
<b>Start Button</b>	This button begins sending the defined tone sequence.

## 5.10.9 Generating an Encoded Signal

This section provides step-by-step instructions for outputting an encoded signal.

### ***To Generate an Encoded Audio Signal***

1. Select **Communications Test** mode of operation.
2. Select the **Full Test Settings button** (  ) to open the **Full Test Settings menu**.
3. Navigate to the **Tone Encoding (Audio)** controls and settings.
4. Select the desired **Encoding Type**.
5. Configure encoding parameters for selected type. Refer to the appropriate encoding parameters at the beginning of this section.

### ***To Generate an Encoded Modulated Signal***

1. Select **Communications Test** mode of operation.
2. Press the **Full Test Settings button** (  ) to open the **Full Test Settings menu**.
3. Navigate to the **Tone Encoding (Demod)** controls and settings.
4. Select the desired **Encoding Type**.
5. Configure encoding parameters for the selected type. Refer to the appropriate encoding parameters at the beginning of this section.

## 5.11 Normalize

The Normalize function performs a series of internal measurements and corrections to reduce measurement inaccuracies which may occur due to environmental conditions such as temperature change. Normalize optimizes various performance parameters, including carrier leakage, IQ gain and balance, Third Order Intercept (IP3), and level correction.



**NOTE**

To ensure accurate alignment, the CX300 must be operating at a stable thermal temperature, therefore, the **Normalize button** is not enabled until after the test set has been powered on for a short time.

Normalize can be set to run automatically when the test set's temperature drifts by more than 5 degrees.



**NOTE**

To ensure proper normalization, prior to running the Normalize procedure, remove all external connections from the test set's RF Input, RF Output, and RF Duplex connectors. Failure to remove external signal sources may introduce inaccuracy in the normalize procedure due to leakage of the incident signal adding or subtracting in phase with the internal normalization source signal.

**Table 5-32 Normalize Controls and Settings**

Parameter	Description
<b>Full</b>	Runs across all frequencies.
<b>Spot</b>	Runs for a specific frequency.
<b>Start</b>	Runs the normalize procedure selected, either a Full or Spot.
<b>Erase</b>	Clears out the normalize factors of compensation.

## 5.12 Frequency List

The Frequency List tool allows users to define frequency list tables which can easily be loaded and applied via the CX300 UI. The CX300 supports.csv formatted files. File contents must be in the order shown below:

Generator Frequency, Receiver Frequency, Generator State, Generator Level

**Frequency List pane** is accessed from the Quick Access Toolbar by pressing the **Frequency List button**. When this button is pressed, the **Quick Access Toolbar** updates to display a pane that contains the frequency list controls and settings.

The **Frequency List pane** displays stored frequency list files. Files can be stored locally in the test set's hard drive or accessed from an external storage device. The Frequency List pane contains the following controls and settings:

**Table 5-33 Frequency List Content**

List Component	Description
<b>Open File</b>	Opens file browser window to selected frequency list file. When a file is selected, the RF Generator and/or Receiver update to the settings defined in the loaded frequency list file.
<b>Previous</b>	Loads the previous frequency defined in the frequency list file.
<b>Next</b>	Loads the next frequency defined in the frequency list file.
<b>Index Button</b>	Displays a frequency from the frequency list file.
<b>Name Button</b>	Displays or selects a frequency from the frequency list file.
<b>Generator Frequency</b>	Frequency to which RF generator will be set. UOM: MHz
<b>Receiver Frequency</b>	Frequency to which RF receiver will be set. UOM: MHz
<b>Set Button</b>	Loads the selected frequency settings.
<b>Generator State</b>	On/Off state of the RF generator Text Format: On or Off.
<b>Generator Level</b>	Output level to which RF Generator will be set. UOM: dBm

## 5.13 Channel Analyzer

The Channel Analyzer is an asynchronous, Fast Fourier Transform (FFT) based analyzer that displays the spectrum of the RF signal received by the test set up to a 8MHz bandwidth, centered on the receive frequency. The source of the signal for the Channel Analyzer is in the receiver chain of the test set, therefore the Channel Analyzer is dependent on the receiver for connector selection, global attenuation and center frequency.

The Channel Analyzer can be viewed in default size, or as an expanded pane. When the Channel Analyzer pane is expanded, frequently used analyzer controls and settings are available on the measurement pane; other controls and settings are accessed from the **Channel Analyzer settings menu**.

### 5.13.1 Channel Analyzer Settings and Controls

This section describes the settings, controls, and indicators located on the Channel Analyzer screen.

**Table 5-34 Channel Analyzer Controls and Settings**

Control/Setting	Description
<b>Span</b>	The signal span can be adjusted by selecting the <b>Span field</b> and entering an arbitrary value. The frequency span of the display must include the RF Frequency being examined.
<b>RBW</b>	Resolution Bandwidth (RBW) menu selects how the Spectrum Analyzer's RBW is defined. <b>Auto</b> When <b>Auto</b> is selected, the system sets RBW to a value appropriate for the signal type. <b>Manual</b> When <b>Manual</b> is selected, RBW can be set manually by selecting a pre-defined value from the RBW menu.

**Table 5-34 Channel Analyzer Controls and Settings (Continued)**

<b>Control/Setting</b>	<b>Description</b>
<b>Window</b>	<p>The window setting selects the shape that is used for processing the received signal, optimizing the signal for different analysis functions such as more accurate amplitude, or a lower noise floor. The main benefit of choosing the proper analysis window is the minimization of side lobes. Select the window according to test analysis requirements and goals.</p> <p><b>Blackman</b></p> <p>The Blackman window is used to minimize side-lobe level, resulting in slightly wider central lobes and less sideband leakage than equivalent length Hamming and Hanning windows. The Blackman window has good characteristics for smoothing in the frequency domain.</p> <p><b>Flattop</b></p> <p>The Flattop window has a better amplitude accuracy in frequency domain and a wider frequency range when compared to the Hanning window. However, drawbacks of the broad bandwidth are poor frequency resolution and high noise bandwidth. For this reason, the Flattop window is typically used on signals with distinct, separated frequency peaks.</p> <p><b>Hamming</b></p> <p>The Hamming window has a sinusoidal shape that stops just short of zero, causing the signal to have a slight discontinuity. The Hamming window cancels the largest side lobe near the main lobe, but fails to address other side lobes.</p> <p><b>Hanning</b></p> <p>The Hanning window has a sinusoidal shape that touches zero at both ends, removing any discontinuity. Hanning window is typically used when performing operational noise and vibration measurements because it is less likely to cause individual peaks to be lost in the spectrum.</p> <p><b>Triangle</b></p> <p>The Triangle window shapes the signal so that the main lobe is twice as wide as the length of the signal without windowing, and the first side lobe twice as far down as the signal without windowing.</p>

**Table 5-34 Channel Analyzer Controls and Settings (Continued)**

<b>Control/Setting</b>	<b>Description</b>
<b>Mode</b>	<p>The <b>Mode button</b> opens a menu that selects the type of trace(s) to be displayed on the plot field. Multiple traces can be selected at any given time on each plot.</p> <p><b>Live</b> Displays live signal trace.</p> <p><b>MinHold</b> Displays lowest signal received.</p> <p><b>MaxHold</b> Displays highest signal received.</p>
<b>Vertical Scale</b>	Allows user to set the range of one division on the vertical scale.
<b>Top of Scale</b>	<p>The <b>Top of Scale field</b> sets the top value on the display graph. Power levels can be measured at any point on the trace in conjunction with the <b>Vertical Scale</b> setting. The top of scale can be set to any value within the specified range.</p> <p>The top of scale of the display must be set so that the RF signal level falls within the display area.</p>
<b>Center Freq</b>	Sets the center frequency of the plot.
<b>Averaging</b>	Sets the number of measurements to be averaged for the trace presentation. A maximum of 100 times of averaging can be set.
<b>Select Trace</b>	Selects active trace to be represented on the analyzer.
<b>Trace View</b>	This toggle button turns the signal trace on or off.

**Table 5-34 Channel Analyzer Controls and Settings (Continued)**

Control/Setting	Description
<b>Trace Type</b>	<p>This setting selects how trace data is processed and displayed in the Trace Reading Block.</p> <p><b>Clear Write</b> Clears current data and display with new measurements.</p> <p><b>Capture</b> Captures the selected trace and compare traces.</p> <p><b>Max</b> Displays the input signal's maximum response only (unlimited or for a certain amount of time).</p> <p><b>Min</b> Display the input signal's minimum response only (unlimited or for a certain amount of time).</p> <p><b>Load</b> Loads a saved trace.</p>
<b>Detectors</b>	<p>The Channel Analyzer uses detectors in order to accurately map the correct signal power to the correct frequency point on the display. The <b>Detector Type</b> selects the type of math that is used to identify specific information in a received signal. The CX300 Channel Analyzer provides the following detector selections:</p> <p><b>Positive Peak</b> When <b>Positive Peak</b> is selected, the Channel Analyzer displays the maximum value of data sampled within the corresponding time interval for each trace point. <b>Positive Peak</b> would typically be used to measure the peak power of a signal.</p> <p><b>Negative Peak</b> When <b>Negative Peak</b> is selected, the Channel Analyzer displays the minimum value of data sampled within the corresponding time interval for each trace point. <b>Negative Peak</b> could be used to help identify CW and pulsed signals by comparing positive and negative peak values.</p>



**Table 5-34 Channel Analyzer Controls and Settings (Continued)**

Control/Setting	Description
	<p><b>Normal</b></p> <p>When <b>Normal</b> is selected, the Channel Analyzer displays the maximum value and the minimum value of the sample data, coinciding with odd versus even numbered data points.</p> <ul style="list-style-type: none"> <li>• Maximum value (+peak): even-numbered data point</li> <li>• Minimum value (-peak): odd-numbered data point</li> </ul>
	<p><b>Mean</b></p> <p>When <b>Mean</b> is selected, the Channel Analyzer displays the power level corresponding to the data point of the corresponding time interval. A sample detector provides a sample for each trace point on the plot field; each trace point represents a single sample evenly spaced across the Span of the frequency domain.</p> <p>A sample detector is effective for measuring noise-like signals or low power continuous wave (CW) signals that are near the analyzer's noise floor.</p>
	<p><b>NOTE</b></p> <p>A sample detector can show an inaccurate reading for the amplitude of a CW signal if the resolution bandwidth (RBW) is set too narrow (reading will be too low).</p>
<b>Trace Clear All</b>	Pressing this button clears all traces from the plot field.

## 5.14 Oscilloscope

The CX300 provides a basic Oscilloscope that can be used to evaluate an electrical signal as it changes over time in order to examine waveform properties such as amplitude, frequency, rise time, time interval, and distortion.

Practical uses of the Oscilloscope are:

- Determining the frequency and amplitude of a signal assists with troubleshooting and debugging a circuit's input and output for identifying a component malfunction.
- Identifying amount of noise in a circuit.
- Identifying waveform shape.

The Oscilloscope can be viewed in default size, or as an expanded window. When the Oscilloscope window is expanded, frequently used controls and settings are available on the measurement window; other controls and settings are accessed from the Oscilloscope test settings menus.

### 5.14.1 Oscilloscope Controls and Settings

The following controls and settings are used to configure the Oscilloscope.

**Table 5-35 Oscilloscope Settings and Controls**

Control/Setting	Description
<b>Sweep</b>	This field defines how quickly the trace sweeps across the Oscilloscope screen. The sweep speed of an oscilloscope is represented by time (seconds) per division.
<b>Source</b>	This toggle switch selects between a demodulated signal or an audio signal as the trace signal source. <b>Audio In</b> <b>Audio In</b> routes the incoming audio signal from the Audio Input connector to the Oscilloscope. The audio input source is selected in the Audio In pane. <a href="#">See section 5.5.2, “Audio In”, on page 5-25.</a> <b>Demod</b> <b>Demod</b> routes the demodulated signal from the RF Input connector to the Oscilloscope. The RF input source is selected in the RF Receiver pane. <a href="#">See section 5.5.1, “RF Receiver”, on page 5-21.</a>



**NOTE**

Signal routing can also be configured on the **Audio Controls window**.

**Table 5-35 Oscilloscope Settings and Controls (Continued)**

Control/Setting	Description
	<b>WARNING</b> Do not overload input connectors. Refer to product labeling or product specifications for maximum input ratings.
<b>Vertical Scale</b>	This setting controls the amplitude of the displayed signal by adjusting the number of Volts per division or modulation units per division displayed between the vertical graticules on the plot field.

### 5.14.2 Configuring the Oscilloscope

The following procedure provides instructions on how to setup the oscilloscope.

#### *To Use the Oscilloscope*

1. Open to the **Oscilloscope settings menu**.
2. Select the **Source (Audio In or Demod)**.
3. Select the desired **Sweep Time** setting.
4. Select the desired **Vertical Scale** setting.

## 5.15 Spectrum Analyzer

The CX300's Spectrum Analyzer is a full-featured spectrum analyzer which utilizes the RF Input or RF Duplex connector. The span is user selectable, as is a wide range of resolution bandwidth (RBW) values. The RBW filters are realized entirely in the CX300's digital IF, providing ideal bandwidth accuracy and shape factor. Video bandwidth (VBW) and sweep time settings can be auto-coupled or manually adjusted for maximum flexibility and ease of use.

The Spectrum Analyzer supports a variety of detectors which allows for accurate power measurements of wide-band and noise-like signals. Up to six traces can be displayed on the screen, each specifiable as clear/write, max hold, min hold, average, blank, or view. The number of trace points and number of trace averages are also user-configurable.

Marker functionality includes peak and next peak functions, with specified level thresholds, delta markers, and frequency counter and noise markers. The Spectrum Analyzer also provides zero-span functionality, allowing time domain analysis.

### 5.15.1 Spectrum Analyzer Controls and Settings

The following controls and settings are used to configure the Spectrum Analyzer:

#### 5.15.1.1 Frequency and Span Controls and Settings

Frequency and span settings define the frequency range used to evaluate signals. If you know the frequency of the signal being evaluated, the center frequency should be set to match the signal's frequency. If you are investigating signals that are within a particular frequency range, it is best to enter a start and stop frequency to define the span.

**Table 5-36 Spectrum Analyzer Frequency and Span Controls and Settings**

Control/Setting	Description
<b>Center Freq</b>	This field sets the horizontal center of the display to a specific frequency. The left and right sides of the graticule correspond to the start and stop frequency values.
<b>Span</b>	This setting defines the frequency range around the center frequency. The span frequency readout describes the total displayed frequency range. To determine span frequency per horizontal graticule division, divide the frequency span by 10.
<b>Start Freq</b>	This field sets the lower end of the frequency span which is the lower range frequency starting at the left side of the plot.
<b>Stop Freq</b>	This field sets the upper end of the frequency span which is the upper range frequency on the right side of the plot.
<b>Full Span</b>	Pressing this button sets the span to full span showing the full frequency range of the instrument.

**Table 5-36 Spectrum Analyzer Frequency and Span Controls and Settings (Continued)**

Control/Setting	Description
<b>Zero Span</b>	Pressing this button sets the frequency span to zero. In Zero Span mode, the current center frequency is displayed in the time domain.
<b>Last Span</b>	Pressing this button reverts the span to the previous span setting.

### 5.15.1.2 Amplitude and Scale

The Amplitude and Scale settings configure how the signal appears on the plot field.

**Table 5-37 Spectrum Analyzer Amplitude/Scale Controls and Settings**

Control/Setting	Description
<b>Input Source</b>	This toggle switch selects the input connector at which the incoming signal is being received.
	<b>WARNING</b> Do not overload input connectors.
<b>Reference Level</b>	This field defines the signal level in relation to the RF Input of the incoming signal; the field should be set according to the expected power level of the incoming signal.
<b>Level Offset</b>	This field defines the value by which to offset the <b>Reference Level</b> value. The <b>Level Offset</b> does not affect <b>RF Attenuation</b> .
<b>Level Offset Enable</b>	This toggle switch is used to apply the <b>Level Offset</b> value to the Spectrum Analyzer <b>Reference Level</b> .
<b>RF Attenuation Mode</b>	This setting selects how the CX300 adjusts the level of the incoming signal. <b>Auto</b> When <b>Auto</b> is selected, the CX300 sets the RF Receiver frequency to the strongest signal detected at the active RF Input connector.

**Table 5-37 Spectrum Analyzer Amplitude/Scale Controls and Settings**

<b>Control/Setting</b>	<b>Description</b>
RF Attenuation Mode (cont)	
	<p><b>Manual</b></p> <p>When <b>Manual</b> is selected, the <b>RF Attenuation</b> field is enabled to allow the user to define how the RF Receiver adjusts for the input level of the incoming signal. <b>Manual</b> would be used in situations in which an external pad or adapter are used in the receive signal path.</p>
<b>RF Attenuation</b>	<p>This field is enabled when <b>RF Attenuation Mode</b> is set to <b>Manual</b>.</p> <p>The <b>RF Attenuation</b> field makes adjustments in signal processing to account for the use of an attenuator pad or adapter. RF Attenuator should be set to a value appropriate to the attenuator pad or adapter being used.</p>
<b>Preamp</b>	<p>This toggle switch determines whether or not the pre-amplifier is included (ON) in the input signal path. The pre-amplifier (PreAmp) is typically used to boost weak incoming signals to eliminate noise and produce a clean signal that is strong enough to be processed.</p>
<b>Scale Unit</b>	<p>This menu selects unit-of-measurement used on the plot scale.</p>
<b>Scale/Div</b>	<p>This setting selects the range of one division of the vertical scale.</p>

### 5.15.1.3 Bandwidth Controls and Settings

The Bandwidth controls and settings are used to define the Resolution Bandwidth (RBW), Video Bandwidth (VBW), and the proportional VBW based on the designated RBW. Selecting Auto changes the value to correspond to your frequency span setting for RBW and to the current RBW and VBW/RBW settings for VBW.

**Table 5-38 Spectrum Analyzer Bandwidth Controls and Settings**

Control/Setting	Description
<b>RBW Mode</b>	<p>This toggle switch selects whether or not the Resolution Bandwidth (RBW) is configured manually by the user or automatically by the system.</p> <p><b>Auto</b></p> <p>When <b>Auto</b> is selected the system sets RBW the best appropriate setting based on detected signal characteristics and the <b>Span/RBW</b> setting.</p> <p><b>Manual</b></p> <p>When <b>Manual</b> is selected, the RBW field is enabled which allows the user to define the RBW value to a specific setting.</p>
<b>RBW</b>	<p>This setting is enabled when <b>RBW Mode</b> is set to <b>Manual</b>. RBW filters are the bandpass filters in the IF path that determine the RF Noise floor and how close two signals can be and still be viewed separately on the analyzer.</p> <p>A narrower RBW setting more clearly displays close signals as separate signals, however, a narrower bandwidth setting results in a longer sweep time.</p> <p>An RBW setting that is too wide causes signals that are closed together to appear as one signal.</p>
 <b>NOTE</b>	<p>Values can be set within the range of 1 Hz to 5 MHz.</p>
<b>Span/RBW</b>	<p>When <b>RBW Mode</b> is set to <b>Auto</b>; this setting is used by the system to determine the RBW setting based on the <b>Span</b> setting.</p>

**Table 5-38 Spectrum Analyzer Bandwidth Controls and Settings (Continued)**

Control/Setting	Description
<b>VBW Mode</b>	<p>This toggle switch selects whether or not the Video Bandwidth (VBW) is configured manually by the user or automatically by the system.</p> <p><b>Auto</b></p> <p>When <b>Auto</b> is selected the system sets VBW the best appropriate setting based on detected signal characteristics and the <b>RBW/VBW</b> setting.</p> <p><b>Manual</b></p> <p>When <b>Manual</b> is selected, the VBW menu is enabled which allows the user to define the <b>VBW</b> value to a specific setting.</p>
<b>VBW</b>	<p>This setting is enabled when <b>VBW Mode</b> is set to <b>Manual</b>. The Spectrum Analyzer includes a low pass filter, called the video filter, in the signal path following the detector. The video filter reduces high frequency noise on the detected signal and allows low level signals to be identified which would otherwise be buried in the noise. The bandwidth of the video filter is called the video bandwidth, or VBW.</p> <p>VBW helps improve resolution of weak signals in the presence of the noise signal. The narrower the VBW, the less noise there is in the output signal; however, the narrower the bandwidth, the longer the sweep time.</p>
	<p><b>NOTE</b></p> <p>Values can be set within the range of 1 Hz to 5 MHz.</p>
<b>VBW/RBW</b>	<p>When <b>VBW Mode</b> is set to <b>Auto</b>; this setting is used by the system to determine the VBW setting based on the RBW setting.</p>



### 5.15.1.4 Trace Settings

Trace controls and settings define how traces are displayed on the Spectrum Analyzer plot field.

**Table 5-39 Spectrum Analyzer Trace Controls and Settings**

Control/Setting	Description
<b>Select Trace</b>	Tap to select trace from the following options: <b>Trace 1</b> , <b>Trace 2</b> , <b>Trace 3</b> , <b>Trace 4</b> , <b>Trace 5</b> , or <b>Trace 6</b> . See <a href="#">Figure 5-7</a> and <a href="#">Figure 5-8</a> .
<b>Trace View</b>	Select the <b>Trace View</b> to <b>On</b> or <b>Off</b> . Once <b>On</b> is selected, you can see the selected trace with its dedicated color on the chart. See <a href="#">Figure 5-7</a> and <a href="#">Figure 5-8</a> .
<b>Trace Mode</b>	Selects the mode used to calculate and display trace data on the plot field.  <b>NOTE</b> When Max Hold or Min Hold are selected, the instrument compares newly acquired data with the active trace, and displays larger maximum values or smaller minimum values on the plot.
	<b>Clear Write</b> Clears current data and display with new measurements, and once selected, <b>W</b> is indicated beside the trace in the <b>Trace Legend</b> .
	<b>Capture</b> Capture the selected trace and compare traces, and once selected, <b>C</b> is indicated beside the trace in the <b>Trace Legend</b> .
	<b>Max Hold</b> Displays the input signal's maximum response only (unlimited or for a certain amount of time), and once selected, <b>M</b> is indicated beside the trace in the <b>Trace Legend</b> .
	<b>Min Hold</b> Display the input signal's minimum response only (unlimited or for a certain amount of time), and once selected, <b>m</b> is indicated beside the trace in the <b>Trace Legend</b> .
	<b>Load</b> Loads a saved trace, and once selected, <b>L</b> is indicated beside the trace in the <b>Trace Legend</b> .

**Table 5-39 Spectrum Analyzer Trace Controls and Settings (Continued)**

<b>Control/Setting</b>	<b>Description</b>
<b>Detectors</b>	<p>The Spectrum Analyzer uses detectors in order to accurately map the correct signal power to the correct frequency point on the display. The Detector Type selects the type of math that is used to identify specific information in a received signal.</p> <p>The Spectrum Analyzer provides the following detector selections:</p> <p><b>Normal</b></p> <p>This setting displays random noise better than the peak without missing signals.</p> <p><b>Peak</b></p> <p>This setting displays the highest value in each data point.</p> <p><b>Negative Peak</b></p> <p>This setting displays lowest value in each data point.</p> <p><b>Sample</b></p> <p>This setting displays the center value in each data point.</p>
<b>Average Count</b>	This field sets the number of measurements used to calculate average trace.
<b>Trace Math</b>	The trace math shows the difference of Trace 1 and Trace 2 measurement results. If Trace 1 and Trace 2 are active, the menu, T1 – T2 -> T5 or T2 – T1 -> T6 become available and you can perform trace math. When performing the trace math, the scale is automatically set and the display of scale for the trace math is on the right side of the screen as below.
<b>T1 - T2 &gt; T5</b>	If <b>Trace 1</b> and <b>Trace 2</b> are active, this menu is activated.
<b>T2 - T1 &gt; T6</b>	If <b>Trace 1</b> and <b>Trace 2</b> are active, this menu is activated.
<b>Trace Clear All</b>	This button clears all plot traces.

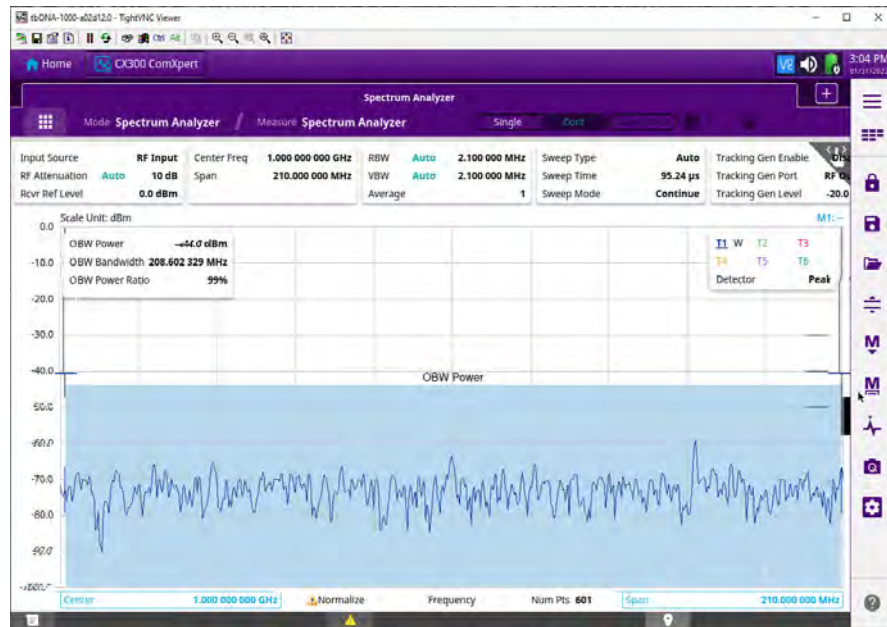

Figure 5-7 Spectrum Analyzer Screen

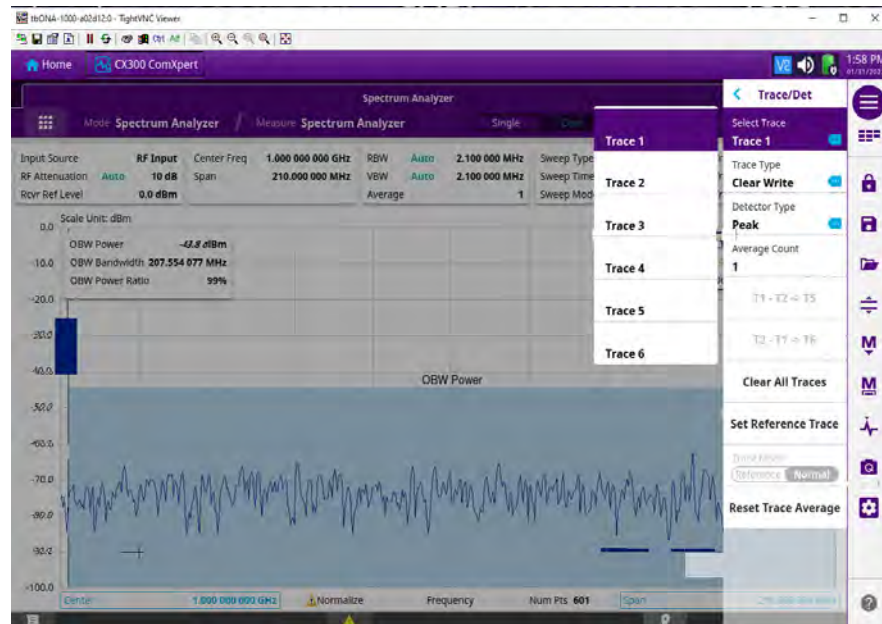

Figure 5-8 Trace Legend Screen

### 5.15.1.5 Setting Sweep and Triggers

Sweep settings are used to define the length of time that the instrument takes to sweep the displayed frequency span (or, in zero span, the time that the instrument takes to sweep the full screen). To perform measurements using certain signal conditions, use trigger settings to configure specific trigger events. When using a trigger source, the CX300 starts to sweep only with the selected trigger conditions are met. The test set can be configured to user an external or internal trigger source.

**Table 5-40 Spectrum Analyzer Band Sweep and Trigger Controls and Settings**

Control/Setting	Description
<b>Sweep Mode</b>	<p>This toggle switch selects whether the analyzer performs signal sweeps continuously, or if the analyzer performs a single sweep before being switched off.</p> <p><b>Single</b></p> <p>In single sweep mode, the measurement is stopped after a single signal sweep.</p> <p><b>Continue (Cont)</b></p> <p>In continuous mode, the analyzer measures continuously, repeating the signal sweep as long as the analyzer is ON.</p>
<b>Sweep Type</b>	<p>This setting is not applicable to Zero-Span Analyzer Mode.</p> <p><b>Manual</b></p> <p>When set to <b>Manual</b>, the <b>Sweep Time</b> setting is used to define the Spectrum Analyze sweep time.</p> <p><b>Auto</b></p> <p>When set to <b>Auto</b>, the instrument optimizes the sweep time based on the characteristics of the incoming signal.</p>
<b>Sweep Time</b>	<p>The <b>Sweep Time</b> field is enabled when <b>Sweep Type</b> is set to <b>Manual</b>.</p> <p>The <b>Sweep Time</b> defines how quickly trace data is acquired (the length of time an analyzer takes to sweep the defined frequency span) and to update the display.</p> <p>This setting must be fast enough to provide quick measurement results, but slow enough to allow the power values at each point to be measured. Reducing the sweep time increases the sweep rate.</p>
<b>Trigger Source</b>	<p><b>Zero Span Trigger Source</b> is enabled when <b>Analyzer Mode</b> is set to <b>Zero-Span</b>. This menu selects the signal source that the CX300 uses for trigger events.</p> <p><b>Free Run</b></p> <p>When <b>Free Run</b> is selected triggering occurs immediately after the a measurement sweep is started.</p>

**Table 5-40 Spectrum Analyzer Band Sweep and Trigger Controls and Settings (Continued)**

Control/Setting	Description
	<p><b>External</b></p> <p>When <b>External</b> is selected, the sweep starts when the level of the external trigger source is greater than or equal to the value defined in the <b>Trigger Level</b> field.</p> <p>When <b>External</b> is selected a valid trigger source must be connected to one of the CX300's Trigger Input Connectors.</p>
<b>Trigger Level</b>	This field defines the level at which a trigger event occurs.
<b>Trigger Offset</b>	This field defines the offset relative to the <b>Trigger Level</b> setting.
<b>Sweep Num Points</b>	This field the number of data points that the Spectrum Analyzer gathers during a single measurement sweep. A higher setting results in more accurate measurement, however, however, a higher number of data points may result in longer acquisition time.

### 5.15.1.6 Measurement Controls and Settings

The following controls and settings enable and configure Spectrum Analyzer Occupied Bandwidth (OBW) and Adjacent Channel Leakage power Ratio (ACLR) measurements.

**Table 5-41 Spectrum Analyzer Measurement Controls and Settings**

Control/Setting	Description
<b>OBW Enable</b>	This toggle switch turns OBW measurements on and off. When OBW readings are turned ON, a meter block is displayed in the upper left corner of the plot field.
<b>% Power BW</b>	This field is enabled when <b>OBW Enable</b> is <b>ON</b> . This field defines the percentage of total power in the displayed frequency range, which defined the OBW.
<b>ACLR Enable</b>	ACLR is the power contained in a specified frequency channel bandwidth relative to the total carrier power. ACLR may also be expressed as a ratio of power spectral densities between the carrier and the specified offset frequency band. The <b>Enable ACLR</b> toggle switch turns ACLR measurements on and off. When <b>Enable ACLR</b> is set to <b>ON</b> , a meter block is displayed in the upper left corner of the plot field.

**Table 5-41 Spectrum Analyzer Measurement Controls and Settings (Continued)**

Control/Setting	Description
<b>Channel Bandwidth</b>	This field is enabled when <b>Enable ACLR</b> is set to <b>ON</b> . This field defines the channel power integration bandwidth as indicated by the vertical bars. The analyzer's span is adjusted automatically based on the combined settings of Channel Spacing and Bandwidth.
<b>Channel Spacing</b>	This field is enabled when <b>Enable ACLR</b> is set to <b>ON</b> . This field defines the channel spacing as indicated by the vertical bar spacing between the reference and adjacent channels.

### 5.15.1.7 Input/Output Controls and Settings

The following input and output controls and settings are used to configure how the Spectrum Analyzer receives and processes an incoming signal:

**Table 5-42 Spectrum Analyzer I/O Controls and Settings**

Control/Setting	Description
<b>Input Source</b>	This setting selects the input connector at which the incoming signal is being received.
	<b>WARNING</b> Do not overload input connectors. Refer to product labeling or product specifications for maximum input ratings.
<b>Auto Alignment</b>	The Spectrum Analyzer contains an auto alignment function that makes adjustments when the test set's internal temperature drifts >5°C over a 30 minute warm-up period. This toggle switch enables or disables the Spectrum Analyzer's auto alignment function.
<b>Align Now</b>	Pressing this button runs the alignment routine.
<b>Reference Input</b>	The <b>Reference Input</b> setting selects the timing source that will be used as a reference frequency and timing source. <a href="#">See section 3.1.13, "Clock Source Screen", on page 3-19</a> for detailed information about references.
<b>Reference Output</b>	This toggle switch enables the frequency reference output at the test set's REF Out connector.

## 5.16 AutoTest Mode

AutoTest mode is an optional automated test environment that allows users to automatically test and / or test and align their radios.

### 5.16.1 AutoTest - Save Profiles Controls and Data

The Save Profiles tab contains controls that are used to select and manage test set files. The Save Profiles tab contains the following controls and indicators:



#### NOTE

Selections that are available within AutoTest depend on the AutoTest options enabled on the test set.

Table 5-43 AutoTest - Save Profiles Controls and Settings

Control/Setting	Description
<b>Manufacturer</b>	This menu contains a list of manufacturers for which radio specific optional auto test scripts are supported. <b>Self Test</b> selects the CX300's automated self test procedure which verifies that the test set is operating properly. <a href="#">See section 8.8, "CX300 ComXpert Self Test Procedure", on page 8-10.</a>
<b>Model</b>	This menu contains a list of radios that are supported for the selected manufacturer.
<b>Test Type</b>	This menu contains the list of Test Sequences that are available for the selected radio.
<b>Set Default Button</b>	Pressing this button resets all AutoTest controls and settings on the <b>Test Menu</b> screen back to default settings.
<b>Edit/Save Button</b>	Opens a dialog window to edit and save the loaded test script.
<b>Import Button</b>	Pressing this button opens a file browser window that is used to select and import an auto test file from an external location to the test set.
<b>Export Button</b>	Pressing this button opens a file browser window that is used to select and export a file from the test set to an external storage location.
<b>Test Name Column</b>	This column identifies the names of test modules that are included in the selected test script.
<b>Test Data Column</b>	This column contains a list of measurements that are included in the selected test type. Selecting a measurement from the list displays the settings that are defined for the selected measurement. Parameters can be edited and saved to the existing file or using a new file name.

## 5.16.2 AutoTest-Test Menu Controls and Setting

The Test Menu tab contains controls for running the test sequence for the selected radio. The Test Menu tab also provides visual indicators that show test status when a test is running. The Test Menu tab contains the following controls and settings:

**Table 5-44 AutoTest - Test Menu Controls and Settings**

Control/Setting	Description
<b>Test Status Data Block</b>	<p>This block indicates AutoTest status, progress and result summary.</p> <p><b>Status</b></p> <p>This status field provides notes on test activity (Inactive, Aborted, Testing, Start, Stop Requested)</p> <p><b>Test Progress</b></p> <p>The number of test files and test functions are counted, this field displays a progress of test activity.</p> <p><b>Result Summary</b></p> <p>This will provide a summary judgment of testing last performed (Pass/Failed).</p>
<b>Manufacturer</b>	<p><a href="#">Table 5-43, “AutoTest - Save Profiles Controls and Settings,” on page 5-71</a> for a description of this control.</p>
<b>Model</b>	<p><a href="#">Table 5-43, “AutoTest - Save Profiles Controls and Settings,” on page 5-71</a> for a description of this control.</p>
<b>Test Type</b>	<p><a href="#">Table 5-43, “AutoTest - Save Profiles Controls and Settings,” on page 5-71</a> for a description of this control.</p>
<b>Read Device</b>	<p>This button triggers the device driver to query the attached radio for model information. This model selection will trigger the model data to update. If the driver is unable to communicate then a dialog will indicate the failure. This is optional - not required for testing.</p>
<b>Run (Start/Abort) Button</b>	<p>This button starts the defined test scripts. When a test is in process, this button updates to an Abort button.</p>
<b>Test Setup Button</b>	<p>Selecting this button opens a window that provides information about how to configure the test set for the selected test.</p>
<b>Test Controls Button</b>	<p>Selecting this button displays the <b>Test Controls window</b>. The controls and settings located in the <b>Test Controls window</b> configure how the AutoTest system manages events such as loop activity, logging, messaging, and audible beep notifications.</p>



Table 5-44 AutoTest - Test Menu Controls and Settings (Continued)

Control/Setting	Description
<b>Enable Tick Boxes</b>	This tick box is used to select and deselect all tests.
<b>Test Name</b>	This field identifies the test module.
<b>Status</b>	This field provides pass/fail status for each of the test modules.
<b>Result Button</b>	This button opens a window that displays test data for the selected test module.
<b>Log Data Pane</b>	The <b>Log Data Pane</b> display pass-fail information from test operations. The pane updates continuously as tests are run.
<b>Clear Log Button</b>	Pressing this button clears logged data on the screen. NOTE: The data still remains in the saved test results.

### 5.16.3 AutoTest - Reports Tab

The **Reports tab** provides access to stored test data and the controls necessary to generate report files. The **Reports tab** contains the following:

Table 5-45 AutoTest - Reports Tab Controls and Settings

Control/Setting	Description
<b>Test Report Meta-Data</b>	The three entry fields on the left ( <b>Customer</b> , <b>Technician ID</b> , and <b>Test Location</b> ) allow the user to better identify the test data.
 <b>NOTE</b>	These fields must be defined before the test is started.
<b>File Directory</b>	Displays all available test data. The model and test time are built into the file name to better identify the appropriate file.
<b>Delete Button</b>	This button is used to remove unnecessary test data files.
<b>View Report Button</b>	Pressing this button will allow the user to view the selected test results on the screen for fast viewing.

## 5.16.4 Using AutoTest

The following procedure describes how to use the AutoTest.

### ***To Run an AutoTest Script***

1. Navigate to the **AutoTest Menu Tab**.
2. Select the desired OEM from the **Manufacturer menu**.
3. Select the OEM radio from the **Model menu**.
4. Select the test type from the **Test Type menu**.
5. Select the test check boxes to enable the test segments to be performed.
6. Press the **Run Start button**.

### ***To Generate a Report***

1. Enter **Customer**, **Technician ID** and **Test Location** data in data fields.
2. Highlight the appropriate test data files.
3. Press the **Create Report button**.



#### **NOTE**

Generated report can be uploaded to StrataSync™ by syncing with the StrataSync™ server.

## 5.17 Navigation Diagrams

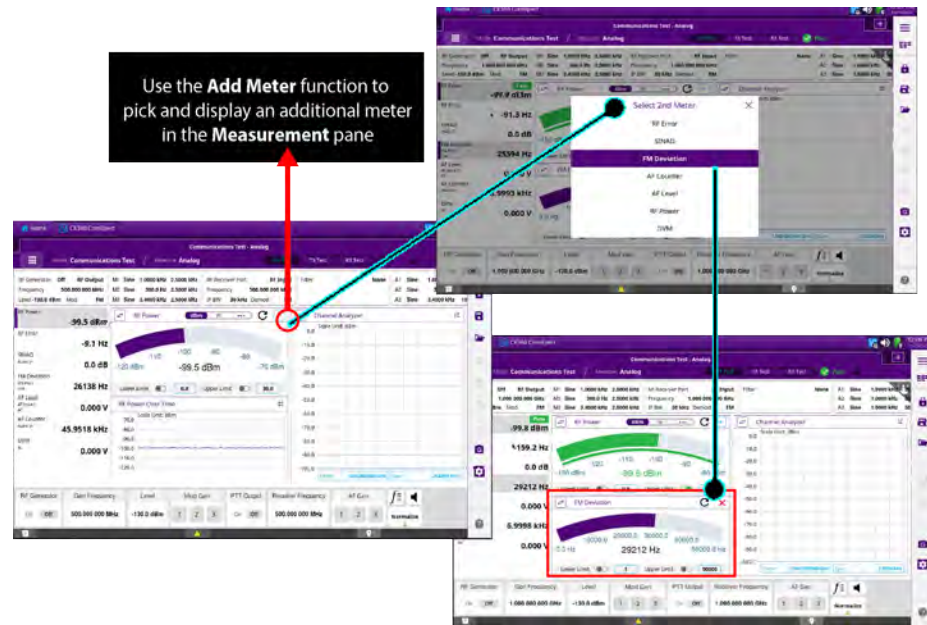

Figure 5-9 Add Meter

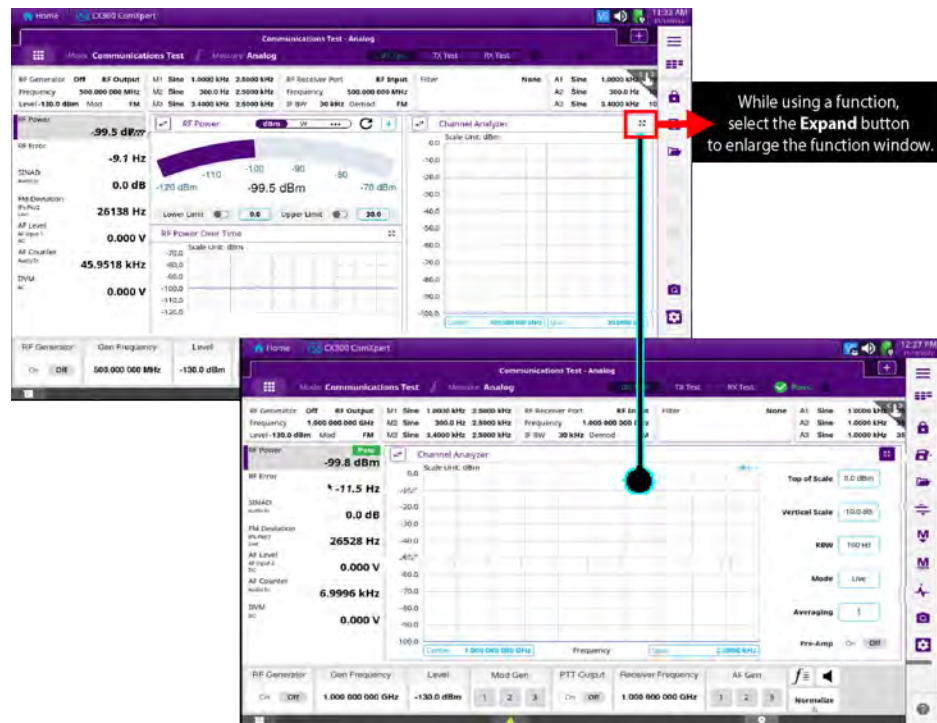

Figure 5-10 Expand button

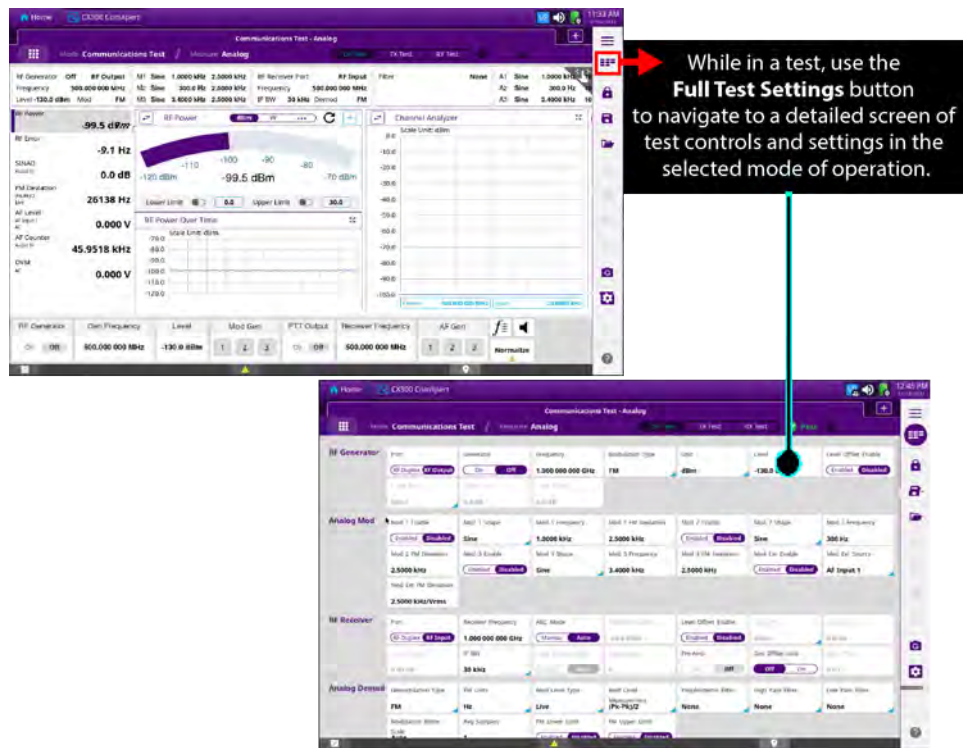

Figure 5-11 Full Test Settings button

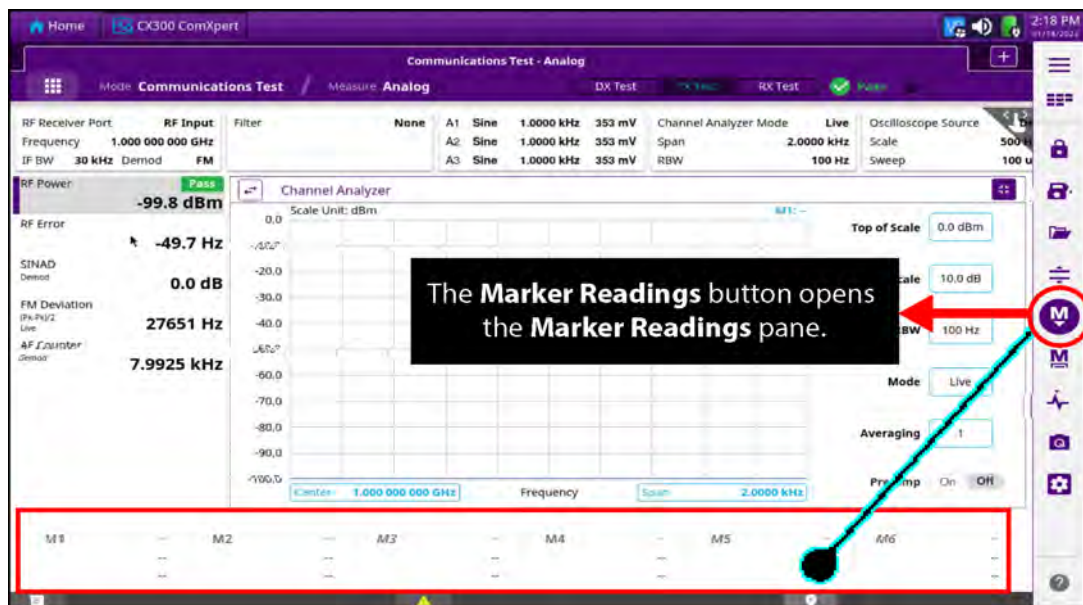

Figure 5-12 Marker Readings button

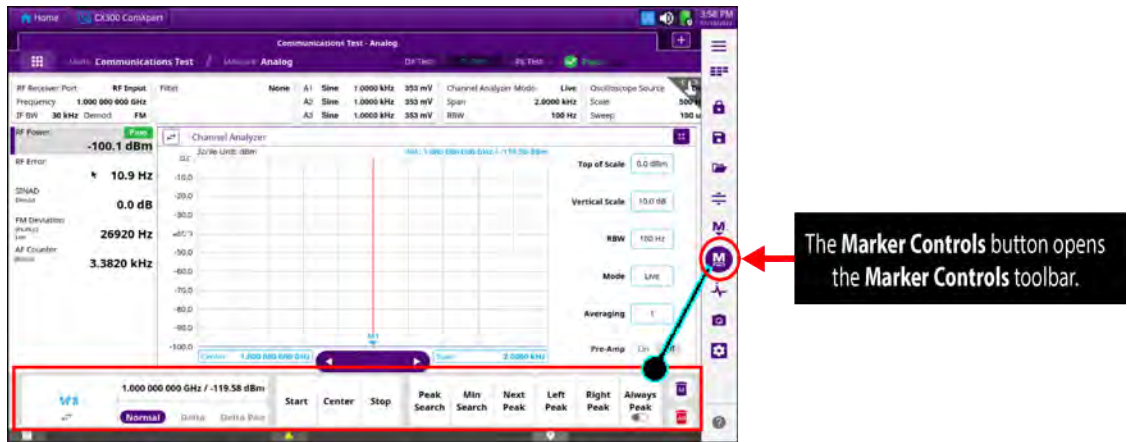

Figure 5-13 Marker Controls button

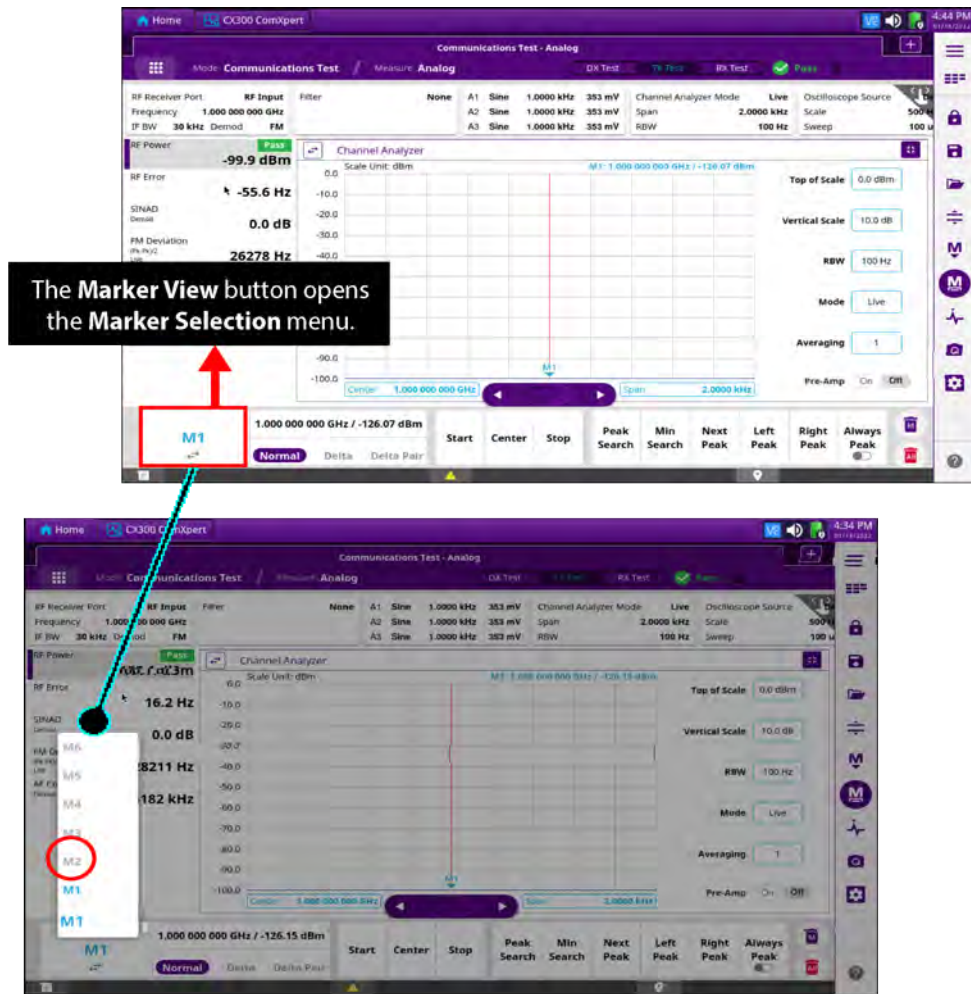

Figure 5-14 Marker View button and Marker Selection menu

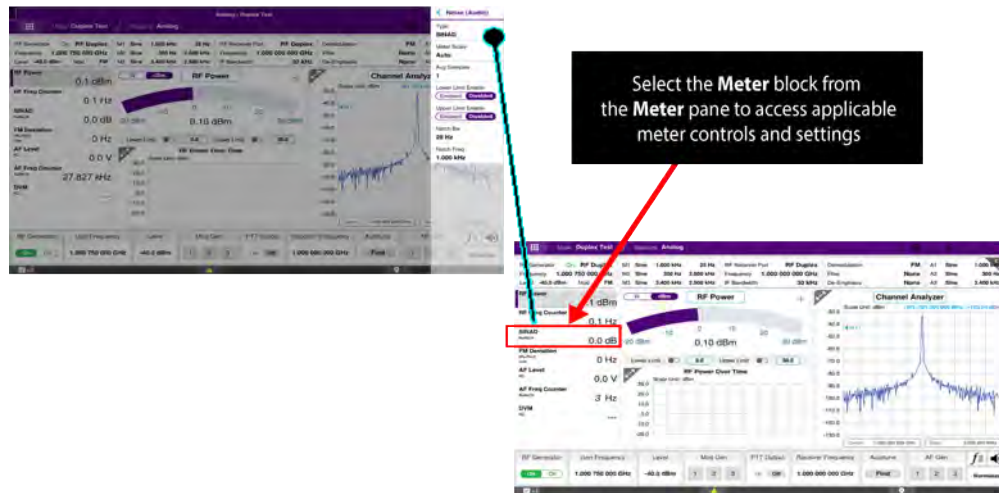

Figure 5-15 Meter pane

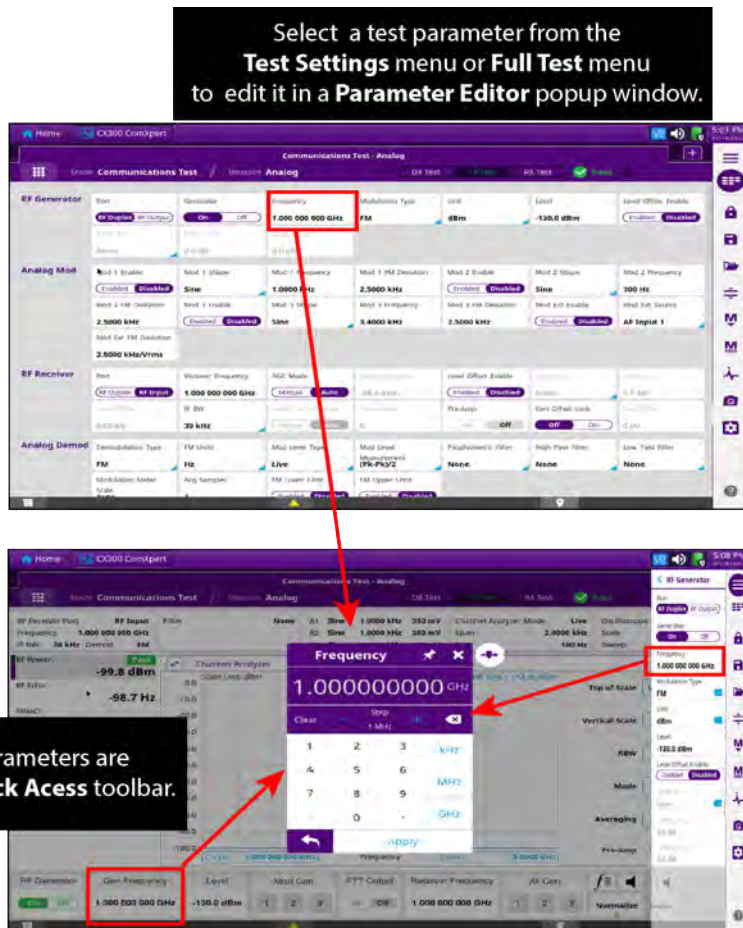

Figure 5-16 Parameter Editor & Quick Access toolbar

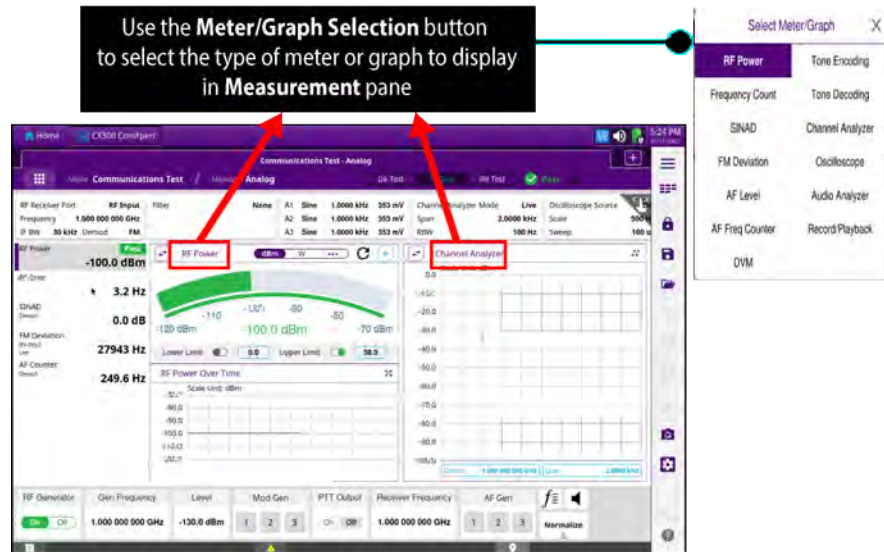

Figure 5-17 Select Meter-Graph type

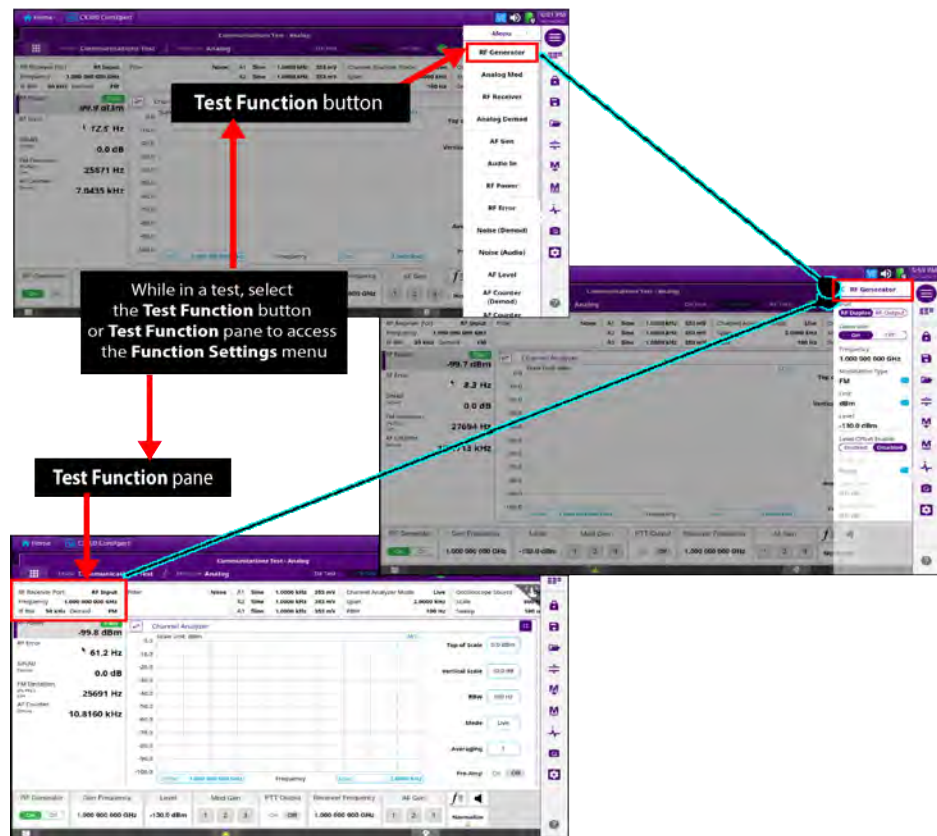

Figure 5-18 Test Function pane & Test Function Settings

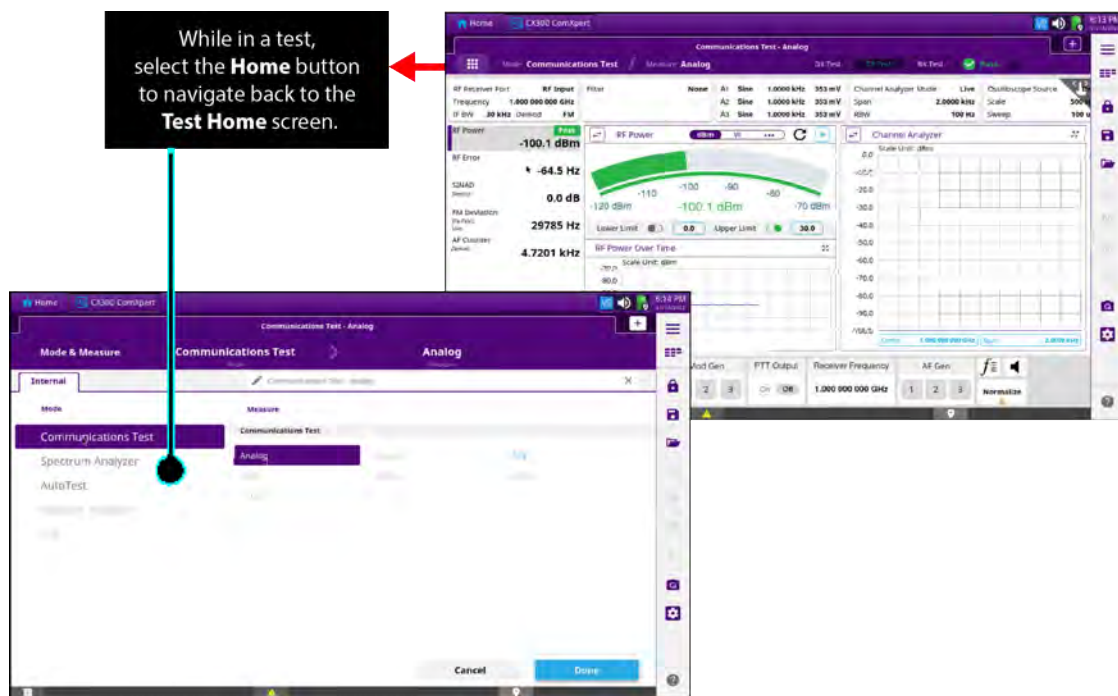

Figure 5-19 Test Home button

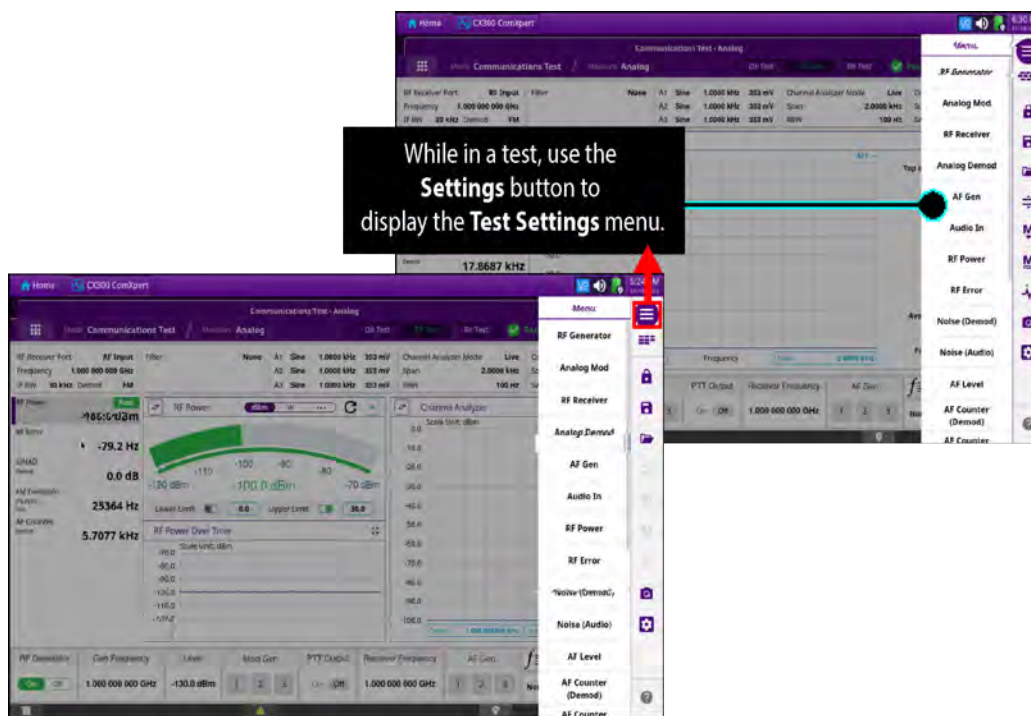

Figure 5-20 Test Settings button



# Performing Tests and Measurements

This chapter provides step-by-step instructions for configuring the CX300 to perform the following tests:

- [RF Connection Configurations](#) . . . . . 6-2
- [CX300 Self Test Procedure](#) . . . . . 6-4
- [FM Transmitter Testing](#) . . . . . 6-6
- [AM Transmitter Testing](#) . . . . . 6-11
- [FM Receiver Performance Tests](#) . . . . . 6-15
- [Channel Power Measurements](#) . . . . . 6-19

See [Chapter 3 “System Settings Screens”](#) for detailed descriptions of the system utility screens and parameters.

See [Chapter 4 “Configuring System Settings”](#) for procedures to configure system settings.

See [Chapter 5 “Test and Measurement Functions”](#) for detailed descriptions of the RF test and measurements screens and parameters.

## 6.1 RF Connection Configurations

The following section describes typical hardware configurations used for RF testing.

### 6.1.1 One Port Duplex

The one port duplex arrangement uses the RF Duplex Connector for RF input and RF output. The one port duplex configuration is typically used for testing mobile radios using a single direct connection to the Unit Under Test. One port duplex configuration also be used for over-the-air testing when only a single antenna is available, or for testing Base stations that use a combined Rx/Tx antenna system.



Figure 6-1 One Port Duplex Test Setup

### 6.1.2 Two Port Duplex

There are three types of two port duplex setups which can be used for measuring RF Generator output and RF Receiver input.

#### 6.1.2.1 RF Output/RF Input

Selecting the RF Output Connector for RF Out and the RF Input Connector for RF Input provides the highest level of RF Generator Output and the most sensitive RF Receiver input. The RF Input Connector is typically used as the Input connector for “over-the-air” testing with separate antennas.

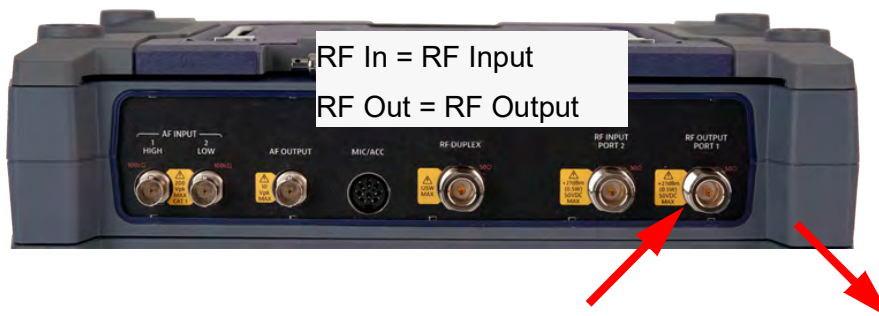

Figure 6-2 RF Output/RF Input Two Port Duplex Test Setup

### 6.1.2.2 RF Output/RF Duplex

Selecting the RF Output Connector for RF Out and RF Duplex Connector for RF Input provides the highest level of RF Generator Output and accepts the highest level of RF Receiver Input. The RF Duplex Connector should be selected as the RF Input connector when connecting the test set directly to a UUT via an RF Cable.



Figure 6-3 RF Output/RF Duplex Two Port Duplex Test Setup

### 6.1.2.3 RF Duplex/RF Input

Selecting the RF Duplex Connector for RF Output and the RF Input Connector for RF Input provides the lowest level of RF Generator output and the most sensitive RF Receiver Input. The RF Input Connector is typically used as the Input connector for “over-the-air” testing.



Figure 6-4 RF Duplex/RF Input Two Port Duplex Test Setup

## 6.2 CX300 Self Test Procedure

### 6.2.1 Scope of Test

The following procedure runs the CX300 automated self-test procedure. This Self Test evaluates system operation to ensure the device is operating properly.



#### NOTE

Self Test evaluates the general functionality of the test set's generate and receive function, instruments and switches, to ensure the device is operating properly. Self Test does not verify that the device is operating to performance specifications.

### 6.2.2 Equipment Needed

No external equipment is needed to perform the CX300 Automated Self Test.

### 6.2.3 Running the Self Test

When the CX300 is received from the factory, perform the following procedure before using the device for the first time:

#### **To Run the CX300 Self Test:**

1. Connect the following cables:
  - Connect an RF Cable from RF Output to RF Input.
  - Connect a BNC Cable from AF Output to AF Input 1 and AF Input 2.
2. Power **ON** the CX300.
3. Verify the **Power Button LED** is illuminated during the boot-up process.
4. When the display loads, select **CX300 ComXpert button** to display the **Test Home screen**.
5. Select the **Auto-Test** function.
6. Press the **Manufacturer button**. Select **Self Test** from the test list.
7. Verify:
  - **CX300 Testset** is selected for the **Model**.
  - **LoopBack** is selected for the **Test Type**.

- Press the **Run Button** to run the test.

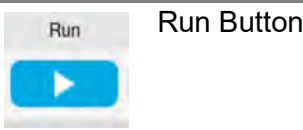

**NOTE**

Do not interrupt these processes or the self test will fail.

- When the self test is finished, verify all portions of the test have passed. Contact VIAVI if any portion of the self-test procedure fails. See [Figure 6-5](#)
- The CX300 is now ready for use.

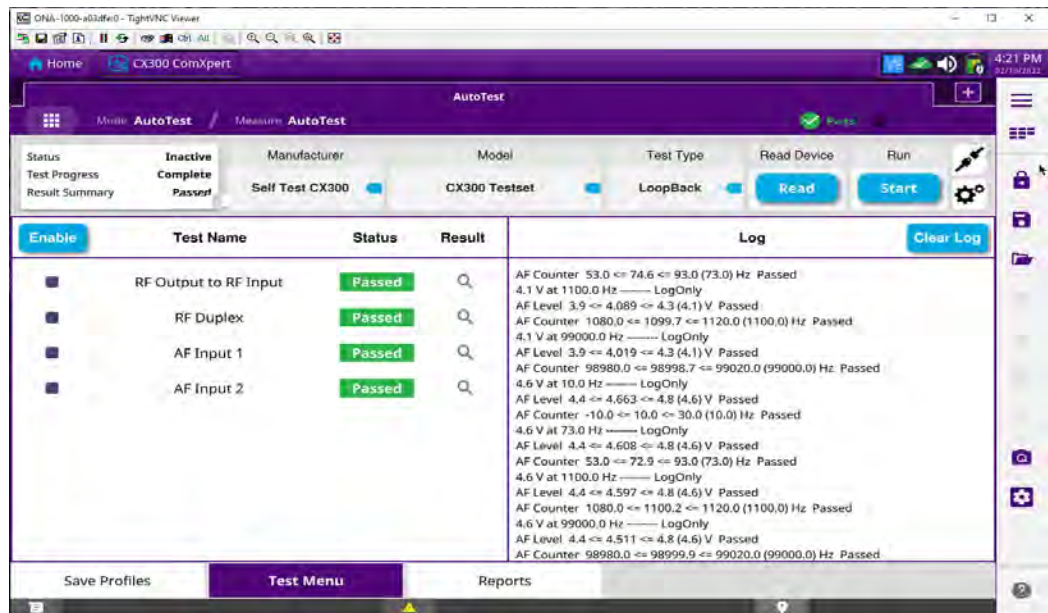

Figure 6-5 Self Test Screen (Example)

## 6.3 FM Transmitter Testing

### 6.3.1 Scope of Test

This test is used to evaluate the following performance characteristics of an FM Transmitter:

- Transmitter Power
- Transmitter Frequency
- Transmitter Distortion
- Voice Modulation Level
- Squelch Tone Frequency
- Squelch Tone Modulation Level

### 6.3.2 UUT Parameters/Characteristics

The example in this section assumes the following UUT characteristics and settings; adjust settings according to the operational capabilities of the UUT.

**Table 6-1 FM Transmitter Tests - UUT Settings**

<b>Parameter</b>	<b>Setting</b>
Transmit Frequency	151.1 MHz
Transmit Power	5 Watts
Transmit Modulation	FM
Maximum Deviation	3 kHz
Maximum Modulation Frequency	3 kHz
Microphone/Mod Input	AC Coupled, Hi-Z
Modulation Input Level for Test Deviation	20 mV
Squelch Tone Deviation	700 Hz
Squelch Tone Frequency	67 Hz

### 6.3.3 Equipment Needed

The following equipment is required to perform the test procedures defined in this section:

- CX300
- Audio cable and MIC/Audio Adapter combination capable of interfacing an audio signal from the CX300 audio output to the transmitter modulation input (typically the microphone input on the transmitter).
- RF Coaxial Cable

### 6.3.4 Test Setup

#### 6.3.4.1 Hardware Setup Diagram

Connect the CX300 and UUT as shown in Figure 6-6, then proceed to the next section.

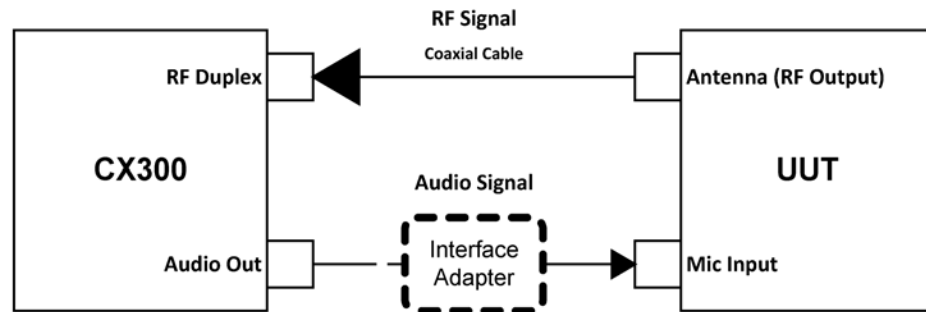

Figure 6-6 Digital Transmitter Test Setup Diagram

#### 6.3.4.2 Configure the CX300 Receiver

In this example, the CX300 RF Receiver uses the following settings:

**To Configure the CX300 RF Receiver:**

1. Power on the CX300.
2. Select either **Duplex Test** or **Transmit Test** mode and **Analog** measurement.



**NOTE**

If operating in **Duplex Test** mode, verify the RF Generator is turned OFF.

3. Select the Full Test Settings button (  ) to open the **Full Test Settings Menu**.
4. Select the Full Test Settings button
5. Navigate to the RF Receiver controls and settings.
6. RF Receiver **Port**: select **RF Duplex**.

7. RF Receiver **Frequency**: set to 151 MHz.
8. RF Receiver **Attenuator**: set to 0.0 dB. Set Automatic Gain Control (AGC) to auto.



**NOTE**

The expected transmit power of the UUT is 5 Watts (37 dBm), which is well below the maximum input power of the CX300 (47 dBm), so no external attenuator is required for this test.

9. RF Receiver **IF Bandwidth**: select 12.5 dBm.
10. AF Filter Selection

When the UUT is keyed, it generates a 67 Hz squelch tone. To determine the voice modulation level and distortion, the 67 Hz tone must be filtered out so that only the 1 kHz test is received by the CX300 when measuring these parameters.



**NOTE:**

In this example, a Band Pass filter is selected so that frequencies lower than 300 Hz will not be received by the CX300 Receiver, and frequencies higher than 3 kHz are also blocked so as not to interfere with the 1 kHz test tone.

11. To configure the CX300 RF Receiver to block the 67 Hz squelch tone generated by the UUT:
12. Navigate to the **Analog Mod** controls and settings.
13. **Demod Type**: select **FM**.
14. **Mod Level Type**: select **Live**.
15. **Mod Level Measurement**: select **(Pk-Pk)/2**.
16. **Psophometric Filter**: **None**.
17. **High Pass Filter**: select **300 Hz**.
18. **Low Pass Filter**: select **20 Hz**.
19. **De-Emphasis**: select **None**.

### 6.3.4.3 Configure the CX300 AF Generator

In this example, the CX300 AF Generator uses the following settings:

**To Configure the CX300 AF Function Generator:**

1. Navigate to the AF Generator controls and settings.
2. **AF Generator 1 Shape**: select **Sine**.



3. **AF Generator 1 Frequency:** set to 1 kHz (test modulation frequency).
4. **AF Generator 1 Level:** set to 0.2 V.
5. **AF Gen 1 Enable:** set to OFF.
6. **AF Gen 2 Enable:** set to OFF.
7. **AF Gen 3 Enable:** set to OFF.
8. Navigate to the Audio In controls and settings.
9. **Coupling:** select **DC**.
10. **Audio 1 Impedance:** select **600  $\Omega$** .

#### 6.3.4.4 Configure the CX300 Meters



##### NOTE

This example does not use upper and lower limits to define pass/fail criteria. Pass/fail criteria can be entered as upper and lower limit values for each meter to obtain visual feedback of pass/fail status.

##### **To Configure the CX300 Meters:**

1. Navigate to the **Noise (Demod)** controls and settings.
2. Noise Demod **Measurement Type:** select **Distortion**.
3. Noise Demod **Notch Bandwidth:** set to 82 Hz.
4. Noise Demod **Notch Frequency:** set to 1 kHz.
5. Upper and Lower Limit values can be assigned if pass/fail criteria are known.
6. Navigate to the **RF Power** controls and settings.
7. Unit-of-measurement: select **dBm** or **W** based on UUT characteristics.
8. Upper and Lower Limit values can be assigned if pass/fail criteria are known.
9. Press the **Normalize soft-key** to normalize the RF Power meter.
10. Close the **Full Test Settings** menu.

## 6.3.5 Gathering and Evaluating Test Data

The following procedures describes how to evaluate test data.

### 6.3.5.1 Viewing Test Data

The following procedure describes how to configure the UI to view test data.

***To Configure the UI to view test data:***

RF Power and Distortion measurements will be displayed in the Meter Pane on the left of the screen. If desired, configure the Measurement Panels in the center of the screen to display the RF Power and Distortion meters.

### 6.3.5.2 Test UUT Power and Frequency

The following procedure describes how to test UUT Power and Frequency.

1. Key the UUT.
2. Review the RF Power meter reading along with overall settings.
3. Review the RF Frequency Error reading.
4. Unkey the UUT.

### 6.3.5.3 Test UUT Modulation Level and Distortion

The following procedure describes how to test UUT Modulation Level and Distortion.

1. Navigate to the AF Function Generator Quick Access Controls.
2. Enable AF Generator 1.
3. Key the UUT and hold.
4. Review the FM Deviation meter reading.
5. Review the Distortion meter reading along with overall settings.
6. Unkey the UUT.

### 6.3.5.4 Test UUT Squelch Tone Modulation Level and Frequency

1. Select the Full Test Settings button (  ) to open the **Full Test Settings Menu**.
2. Navigate to the **Analog Mod** controls and settings.
3. Set the **Low Pass Filter** to **300 Hz**. This will allow the 67 Hz Squelch Tone to pass for measurement, while blocking audio signals above 300 Hz.
4. Close the Full Test Settings Menu.
5. Key the UUT and hold.
6. Review the FM Deviation meter reading.
7. Review the AF Counter meter reading along with overall settings.
8. Unkey the UUT.

## 6.4 AM Transmitter Testing

This section explains how to configure the CX300 to evaluate the transmit performance of an AM device. The test setup in this section can be used to evaluate the following UUT parameters:

- AM Transmitter Power
- AM Transmitter Frequency
- Modulation Level
- Transmitter Distortion

### 6.4.1 UUT Parameters/Characteristics

The example in this section assumes the following UUT characteristics and settings; adjust settings according to the operational capabilities of the UUT.

**Table 6-2 AM Transmitter Tests - UUT Settings**

<b>Parameter</b>	<b>Setting</b>
Transmit Frequency	116.5 MHz
Transmit Power	50 Watts
Transmit Modulation	AM
Maximum Modulation Index	100%
Maximum Modulation Frequency	3 kHz
Microphone/Mod Input	DC Coupled, 600 Ohm
Modulation Input Level for Test Modulation	30 mVrms

## 6.4.2 Equipment Needed

The following equipment is required to perform the test procedures defined in this section:

- CX300 ComXpert Test Set
- Audio cable and MIC/Audio Adapter combination capable of interfacing an audio signal from the CX300 audio output to the transmitter modulation input (typically the microphone input on the transmitter).
- RF Coaxial Cables (2 ea)
- 10 dB RF Attenuator (1 ea)

## 6.4.3 Configuring Equipment

Connect the CX300 and UUT as shown in Figure 6-7, then proceed to the next section.

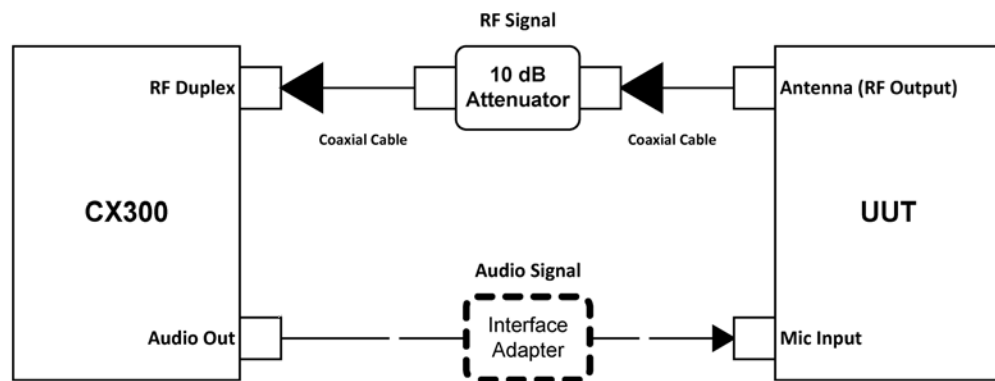

Figure 6-7 Digital Receiver Test Setup Diagram

In this example, the CX300 RF Receiver uses the following settings:

### To Configure the CX300 RF Receiver:

1. Power on the CX300.
2. Select either **Duplex Test** or **Transmit Test** mode and **Analog** measurement.



### NOTE

If operating in Duplex Test mode, verify the RF Generator is turned OFF.

3. Select the Full Test Settings button (  ) to open the **Full Test Settings Menu**.
4. Navigate to the RF Receiver controls and settings.
5. RF Receiver **Port**: select **RF Duplex**.
6. RF Receiver **Frequency**: set to 116.5 MHz.

7. RF Receiver **Reference Level**: set to 27 dBm. Select to AGC to auto.



**NOTE - Use of External Attenuator**

The expected transmit power of the UUT is 50 Watts (47 dBm) which is the maximum input power of the CX300, so an external attenuator is required for this test.

The UUT transmits at 47 dBm through the 10 dB external attenuator, reducing the amplitude received by the CX300 to 37 dBm (5 W), therefore the Reference Level of the CX300 is set to 37 dBm so that the power measurements factor in external attenuation to reflect the actual power generated by the UUT.

8. RF Receiver **IF Bandwidth**: select 6.25 kHz.



**NOTE - IF Bandwidth Selection**

For this test, the UUT will generate AM using a 1 kHz tone, which is a narrow-band signal, so the IF Bandwidth is set to the narrowest setting of 6.25 kHz.

9. Navigate to the **Analog Mod** controls and settings.
10. **Demod Type**: select **AM**.
11. **Mod Level Type**: select **Live**.
12. **Mod Level Measurement**: select **(Pk-Pk)/2**.
13. **Psophometric Filter**: **None**.
14. **High Pass Filter**: select **300 Hz**.
15. **Low Pass Filter**: select **5 kHz**.

In this example, the CX300 AF Generator uses the following settings:

**To Configure the CX300 AF Function Generator:**

1. Navigate to the **AF Generator** controls and settings.
2. AF Generator 1 **Shape**: select **Sine**.
3. AF Generator 1 **Frequency**: set to 1 kHz (test modulation frequency).
4. AF Generator 1 **Level**: set to 0.2 V.
5. **AF Gen 1 Enable**: set to OFF.
6. **AF Gen 2 Enable**: set to OFF.
7. **AF Gen 3 Enable**: set to OFF.
8. Navigate to the Audio In controls and settings.
9. **Coupling**: select **DC**.

10. **Audio 1 Impedance:** select **600  $\Omega$** .

**To Configure the CX300 Meters:**

1. Navigate to the Noise (Demod) controls and settings.
2. Noise Demod **Measurement Type:** select **Distortion**.
3. Noise Demod **Notch Bandwidth:** set to 82 Hz.
4. Noise Demod **Notch Frequency:** set to 1 kHz.
5. Upper and Lower Limit values can be assigned if pass/fail criteria are known.
6. Navigate to the **RF Power** controls and settings.
7. Unit-of-measurement: select **dBm** or **Watt** based on UUT characteristics.
8. Upper and Lower Limit values can be assigned if pass/fail criteria are known.
9. Press the **Normalize soft-key** to normalize the RF Power meter.
10. Close the **Full Test Settings** menu.

## 6.4.4 Gather and Evaluate Test Data

The following procedure describes how to gather and evaluate test data.

### 6.4.4.1 Viewing Test Data

The follow procedure describes how to view test data.

**To Configure the UI to view test data:**

RF Power and Distortion measurements will be displayed in the Meter Pane on the left of the screen. If desired, configure the Measurement Panels in the center of the screen to display the RF Power and Distortion meters.

## 6.4.5 Test UUT Power and Frequency

The following procedure describes how to test UUT Power and Frequency.

1. Key the UUT.
2. Review the RF Power meter reading along with overall settings.
3. Review the RF Frequency Error reading.
4. Unkey the UUT.

## 6.4.6 Test UUT Modulation Level and Distortion

The following procedure describes how to test UUT Modulation and Distortion.

1. Navigate to the AF Function Generator Quick Access Controls.
2. Enable AF Generator 1.
3. Key the UUT and hold.
4. Review the FM Deviation meter reading.
5. Review the Distortion meter reading along with overall settings.
6. Unkey the UUT.

## 6.5 FM Receiver Performance Tests

This test is used to evaluate the following performance characteristics of an FM Receiver:

- Radio Receive Sensitivity
- Squelch Tone Response
- Audio Level

### 6.5.1 UUT Parameters/Characteristics

The example in this section assumes the following UUT characteristics and settings; adjust settings according to the operational capabilities of the UUT.

**Table 6-3 FM Receiver Test - UUT Parameters**

Parameter	Setting
FM Receiver	Narrow band
FM Receiver Frequency	151.1 MHz
Distortion	Less than 1% at 700 mV audio level
12 dB SINAD	-118 dBm
Squelch Tone Deviation	700 Hz
Squelch Tone Frequency	67 Hz

## 6.5.2 Equipment Needed

The following equipment is required to perform the test procedures defined in this section:

- CX300 ComXpert Test Set
- Audio cable and MIC/Audio Adapter combination capable of interfacing an audio signal from the UUT demodulated output (typically speaker out signal) to the CX300 audio input connector.
- RF Coaxial Cable (1 each)

## 6.5.3 Configuring Equipment

The following procedure illustrates the hardware setup diagram.

Connect the CX300 and UUT as shown in [Figure 6-8](#), then proceed to the next section.

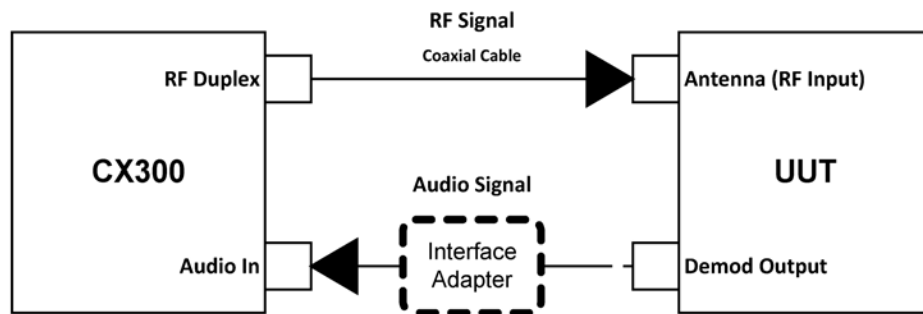

**Figure 6-8 Receiver Test Setup Diagram**

The following procedure describes how to configure the CX300 RF Generator.

In this example, the CX300 RF Generator uses the following settings:

### **To Configure the CX300 RF Generator:**

1. Power on the CX300.
2. Select either **Duplex Test** or **Receive Test** mode and **Analog** measurements.
3. Select the Full Test Settings button (  ) to open the **Test Settings** menu.
4. Navigate to the **RF Generator** controls and settings.
5. RF Generator **Port**: select **RF Duplex**.
6. RF Generator **Frequency**: set to 151.1 MHz.
7. RF Generator **Output Level**: set to -50 dBm.



The following procedure describes the CX300 Modulation Generators.  
In this example, the CX300 Modulation Generators use the following settings:

**To Configure the CX300 Modulation Generators:**

1. Navigate to the **Analog Mod** controls and settings.
2. **Modulation Generator 1 Mod Type**: select **FM**.
3. **Modulation Generator 1 Shape**: select **Sine**.
4. **Modulation Generator 1 Frequency**: set to 1.000 kHz.
5. **Modulation Generator 1 FM Deviation**: set to 3.0000 kHz.
6. **Mod 1 Enable** toggle switch set to **Enabled**.
7. **Modulation Generator 2 Shape**: select **Sine**.
8. **Modulation Generator 2 Frequency**: set to 0.0670 kHz.
9. **Modulation Generator 2 Deviation**: set to 0.7000 kHz.
10. **Mod 2 Enable** toggle switch set to **Enabled**.
11. **Mod Ext Enable** toggle switch set to **Disabled**.

The following procedure describes how to set up the CX300 Meters.



**NOTE**

Meter parameters should be configured according to UUT performance characteristics and test requirements.

In this example, the CX300 meters are configured as follows:

**To Configure the CX300 Meters:**

1. Navigate to the **Demod Noise meter** controls and settings.
2. **Measurement Type**: select **Distortion**.
3. Enable the **Lower Limit**.
4. Set the **Lower Limit** to 1%.
5. Change the measurement **Type** to **SINAD**.
6. Enable the **Lower Limit**.
7. Set the **Lower Limit** to 12.0 dB.
8. Set **Average Count** to 20.
9. **Notch Bandwidth**: set to 82 Hz.

10. **Notch Frequency:** set to 1 kHz.
11. Navigate to the **Audio Level** meter controls and settings.
12. Enable the **Upper Limit**.
13. Set the **Upper Limit** to +0.710 V.
14. Enable the **Lower Limit**.
15. Set the **Lower Limit** to +0.690 V.

## 6.5.4 Gather and Evaluating Test Data

The following procedure describes how to gather and evaluate test data.

### ***To Configure the UI to view test data:***

Measurements will be displayed in the Meter Pane on the left of the screen. If desired, configure the Measurement Panels in the center of the screen to display the Audio Level and Noise meter.

The following procedure describes how to perform the UUT Audio Level and Distortion tests.

1. Adjust the UUT volume until the Audio Level meter displays approximately 700 mV and the meter background color is green (indicates pass condition).
2. Verify the Distortion meter displays less than 1% Distortion and the meter bar color is green (indicates pass condition).

### 6.5.4.1 UUT Squelch Tone Function Tests

1. Disable Modulation Generator 2.
2. Observe the Audio Level meter to verify the UUT is quieted, and that the AF Counter does not display 1.000 kHz audio.
3. Enable Modulation Generator 2.
4. Use the Audio Level meter to verify the UUT is demodulating the CX300 modulation, and that the AF Counter displays 1.000 kHz audio.

The following procedures describes how to perform the UUT Receiver Sensitivity Tests.

1. Set the CX300 RF Generator Level to -118.000 dBm.
2. Navigate to the Demod Noise meter controls and settings and change Type to SINAD.

3. Press the meter Refresh button.
4. Observe the SINAD meter and verify its reading is 12 dB or greater, and that the meter bar color is green (indicates pass condition).

## 6.6 Channel Power Measurements

### 6.6.1 Scope of Test

This test is used to identify the following signal characteristics:

- Total RF power
- Power Ratio
- Adjacent Channel Power Ratio (ACPR)

### 6.6.2 UUT Parameters

The example in this section assumes the following UUT parameters; The user should adjust settings according to the operational capabilities of the UUT.

**Table 6-4 Spectrum Analyzer Channel Power - UUT Parameters Example**

UUT Parameters
Transmit Frequency
Transmit Power
Transmit Modulation
Maximum Deviation
Maximum Modulation Frequency
Microphone/Mod Input
Modulation Input Level for Test Deviation
Squelch Tone Deviation
Squelch Tone Frequency
Transmit Frequency

### 6.6.3 Equipment Needed

The following equipment is required to perform the test procedures defined in this section:

- CX300 ComXpert Test Set
- RF Coaxial Cable (1 each)

## 6.6.4 Configuring Equipment

The following procedures illustrates the Hardware Setup Diagram.

Connect the CX300 and UUT as shown in [Figure 6-9](#), then proceed to the next section.

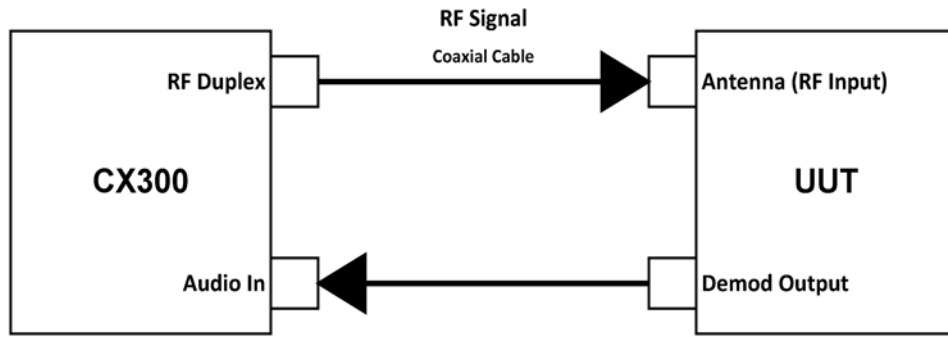



Figure 6-9 Channel Power Measurements Setup Diagram

The following procedure describes how to configure the Spectrum Analyzer.

In this example, the CX300 Spectrum Analyzer uses the following settings:

1. Power on the CX300.
2. Select **Spectrum Analyzer Test** mode.
3. Select the Full Test Settings button (  ) to open the **Full Test Settings Menu**.
4. Navigate to the **Input/Output** controls and settings.
5. **Input Source**: select **RF Duplex**.
6. Navigate to the **Frequency** controls and settings.
7. Set the frequency range over which the instrument will sweep.
8. Navigate to **Trace** controls and settings.
9. **Detector Type**: select **RMS**.
10. **Average Count**: set to desired value.
11. Navigate to the **Sweep** controls and settings.
12. **Sweep Mode**: select **Continue**.
13. **Sweep Type**: select **Auto**.

14. Navigate to **Measurement** controls and settings.
15. **Channel Bandwidth**: As an example: set to 25 kHz
16. **Channel Spacing**: As an example: set to 50 kHz
17. **ACLR Enable**: set to **Enabled**.
18. Perform and document gather and evaluate test data.

This page intentionally left blank.

# Managing Files and Reports

This chapter describes how to save files, test data and screen shots, how to generate reports and manage file transfer to and from the CX300 ComXpert. This chapter reviews the following information:

- [Managing Files](#) ..... 7-2
  - [Saving Files](#) ..... 7-2
  - [Using Save to Event Setup](#) ..... 7-3
  - [Using Quick Save Setup](#) ..... 7-3
  - [Creating a Report](#) ..... 7-4
  - [Loading Files](#) ..... 7-4
- [File Manager Controls](#) ..... 7-5

## 7.1 Managing Files

The CX300 allows users to save screen captures, test results, test set configuration files, logged data, and Fail events depending on the selected measurement modes and options.



### 7.1.1 Saving Files

This section contains instructions to save the current screen, test result or setup to the internal memory or an external USB memory drive, USB A or USB B or SD card.



#### NOTE

When using the Save feature, Screen Hold is automatically enabled.  
A USB memory device must be connect to USB A or B port to enabled these locations.  
An SD card must be inserted into the Micro SD port to enable this location.

1. Press the **Save** (  ) **Button**.
2. Press the **Folder** (  ) **Button** to select the storage location.
3. Select the **File Name** input field.
4. Select the file type based on the following:
  - a. Select **Result** to save the measurement result with a file type, `.trav` and `.gomv` (Route Map).
  - b. Select **Result as CSV** to save the measurement result with a file type, `.csv`.
  - c. Select **Setup** to save the setup and test configuration with a file type, `.stav`.
  - d. Select **Report** to save the measurement result in a report format with comments and captured screen images with a file type, `.pdf`.
  - e. Select **Screen** to save the current screen with a file type, `.png`.



#### NOTE



The file type Result and Result as CSV is inactivated (greyed-out) based on the selected measurement mode.

5. *Optional.* Select to switch the Color Inversions to On to invert the image color (only available for Screen or Report file types).
6. Press the **Save Button** to save the file.



## 7.1.2 Using Save to Event Setup

Depending on the measurement mode, the test set can be configured to automatically save measurement screen or result that falls outside the defined limit settings or when the Fail indicator is on. The test set can also be configured to save the first event and pause the measurement, or to save all the events continuously.

1. Press the **Save** (  ) **Button**.
2. Press the **Folder** (  ) **Button** to select the storage location.
3. Select the **Save to Event Setup** box.
4. Select the **File Name** input field and enter the file name using the on-screen keyboard.
5. Select to select the **File Type** from the following options: **Result**, **Result as CSV**, and **Screen**.
6. Select to switch the **Save On Event** to **On** or **Off**. If the Save On Event is On, it is saved with the selected file type in accordance with limit(s) fail.
7. Select to switch the **Save Then Stop** to **On** to save the first event that fails outside the limit(s) and to hold the measurement. Otherwise, leave this feature off to save events continuously.
8. *Optional:* Select to switch the **Color Inversions** to **On** to invert the image color.
9. Press the **Save Button** to save the file.

## 7.1.3 Using Quick Save Setup





The following procedure describes using the Quick Save Setup.

You can save your configured settings by using this Quick Save Setup feature.

1. Press the **Quick Save Setup** box.
2. Select the **File Name** input field and enter the file name using the on-screen keyboard.
3. Select to select the **File Type** from the following options: **Result**, **Report**, and **Screen**. If the file type is not selected, it is saved as a Screen type.
4. Press the **Apply** button to apply the settings.

## 7.1.4 Creating a Report



### *To create a report:*

1. Press the **Save** (  ) Button.
2. Press the **Folder** (  ) Button to select the storage location.
3. Select the **File Name** input field.
4. Enter the file name to use when saving the file.
5. Select the **Report** file type.
  - a. Select the **Report Setup** box.
  - b. Insert the company image using the  **Button**.
  - c. Enter the company name in the **Company Name Here** field.
  - d. Enter the name of the person who performed testing in the **Your Name Here** field.
  - e. Enter the company or site address in the **Address** field.
  - f. Enter a description about the site or place in the **Site Information** field.
  - g. Enter the purpose of the test in the **Test Purpose** field.
  - h. Enter a summary of the test results in the **Result** field.
6. Press the **Image Add** (  ) button to add up to six screen shots.
7. Press the **Apply** button.

## 7.1.5 Loading Files

The CX300 File Browser is used to access and manage files stored on the device or on a USB flash drive that is connected to device. You can load your saved screen, result, and setup from the internal memory or your external USB memory drive, USB A or USB B or SD card.







### *To Load a File*

1. Press the File Browser  **Button**.
2. Press the **Folder** (  ) **Button** to select the file location.
3. Select the file to be loaded from the internal memory or from your USB drive.
4. Check the file information on the right pane.
5. Press the **Load Button** to load the file.

## 7.2 File Manager Controls

The CX300 lets you create a user-defined folder, select, copy, cut, paste, and delete data files saved in the internal memory or on your USB device. Data files are managed using the buttons below.

**Table 7-1 File Management Controls**

Items	Name	Description
	<b>Select</b>	Press the <b>Folder ( ) Button</b> to open the files or folders. Press the <b>Select</b> button to choose files or folders.
	<b>New</b>	Press this <b>Button</b> to create a new folder. Once selected, the on-screen keyboard pops up and enter any folder name that you want to create.
	<b>Copy</b>	Press this <b>Button</b> to copy a selected file or folder.
	<b>Paste</b>	Press this button to paste the copied or cut file or folder to the location where the file or folder to be pasted. Press the <b>Folder ( ) Button</b> to select the location where the file or folder will be pasted. The default setting is grayed out and it is only activated when copy and cut is performed.
	<b>Cut</b>	Press this <b>Button</b> to cut a selected file or folder.
	<b>Undo</b>	Press this <b>Button</b> to undo the copy, cut or select function. The default setting is grayed out and is only activated when copy and cut is performed.
	<b>Delete</b>	Press this <b>Button</b> to delete a selected file or folder. The confirmation dialog box appears. When a file or folder is deleted, it cannot be recovered.



**NOTE**

You can select the file or folder by selecting it from the File Information pane on the left. Once selected, the item will be highlighted as purple.

This page intentionally left blank.

# Care, Maintenance, and Troubleshooting

This chapter reviews care and maintenance procedures, as well as operator level troubleshooting procedures for the CX300 ComXpert. This chapter reviews the following topics:

- Storing the Device ..... 8-2
- Shipping Instructions ..... 8-2
  - Return Material Authorization (RMA) ..... 8-2
  - Tagging the Equipment ..... 8-2
  - Shipping Containers ..... 8-2
  - Freight Costs ..... 8-2
  - Packing Procedure ..... 8-3
- Operator Level Maintenance ..... 8-4
  - Visual Inspections ..... 8-4
  - External Cleaning ..... 8-4
- Charging the Battery ..... 8-5
- Battery Replacement ..... 8-6
  - Battery Part Information ..... 8-6
  - Battery Removal ..... 8-6
  - Battery Installation ..... 8-7
- Resetting the ComXpert Base ..... 8-9
- Updating Software ..... 8-9
- CX300 ComXpert Self Test Procedure ..... 8-10
- Troubleshooting Information ..... 8-10
  - Troubleshooting Symptom Index ..... 8-10
  - Troubleshooting Guide ..... 8-11

## 8.1 Storing the Device

Store the device in a clean, dry place according to label specifications.

## 8.2 Shipping Instructions

Any device returned to the factory for calibration, service or repair must be repackaged and shipped subject to the following conditions:

### 8.2.1 Return Material Authorization (RMA)

Request a Return Material Authorization (RMA) number. Do not return any products to the factory without prior authorization from VIAVI.

Refer to the following links for relevant information:

- To request an RMA  
<https://www.viavisolutions.com/en-us/support/customer-care/return-material-authorization-rma-request-avionics-radio-test-us>
- For general shipping information  
<https://www.viavisolutions.com/en-us/general-shipping-instructions-avionics-radio-test-rmas>

### 8.2.2 Tagging the Equipment

All items shipped to VIAVI must be tagged with:

- Owner's Identification and contact information
- Nature of service or repair needed
- Model Number and Serial Number
- Return Authorization (RA) Number

### 8.2.3 Shipping Containers

Devices must be repackaged in original shipping containers using VIAVI packing materials. If original shipping containers and materials are not available, contact VIAVI for shipping instructions.

### 8.2.4 Freight Costs

All freight costs on non-warranty shipments are assumed by the customer. VIAVI recommends that customers obtain freight insurance with the freight carrier when shipping the Device. VIAVI is not responsible for cost of repairs for damages that occur during shipment on warranty or non-warranty items.

## 8.2.5 Packing Procedure

The following procedure is for shipping the CX300.

### *How to Package the Test Set for Shipping*

1. Visit the VIAVI website to obtain an RMA number, for return address, and for questions about proper packaging (see [page 8-2](#)).
2. Tag the equipment (test set and any accessories).
3. Install front cover on test set.



#### **CAUTION**

It is highly recommended to remove the batteries prior to packing the test set to avoid accidental activation.

4. Place the test set between foam inserts.
5. Place the secured test set in shipping container.
6. Seal shipping container with tape.
7. Include RMA number on the packaging label.

## 8.3 Operator Level Maintenance

The following procedures may be performed by the Operator. All other service must be performed by Qualified Service Personnel.

### 8.3.1 Visual Inspections



#### CAUTION

This device does not contain user serviceable parts. Servicing should only be performed by Qualified Service Personnel.

Do not operate this device with the case/cover open. Opening the case/cover exposes the operator to electrical hazards which can result in electrical shock or damage to the Device.

Visual inspections should be performed periodically depending on operating environment, maintenance, and use.

- Verify test set has been installed in accordance with the instructions provided (e.g., that ventilation is adequate, supply wiring is adequate and properly routed).
- Ensure that AC Power Cord and supply connector are in good condition.
- Check for presence and condition of all warning labels, markings, and supplied safety information.
- Inspect connectors for dirt, dust, corrosion or rust.
- Inspect the device and accessories for damage. Do not use if there is damage to the exterior of the unit or power accessories.
- Examine the stability and condition of covers, handles, and carry straps when used.

### 8.3.2 External Cleaning

The following contains routine instructions for cleaning the outside of the CX300. The following should be performed by the operator on a routine basis:

- Clean display with soft lint-free cloth to remove dirt, grime and lint. If surface of display is difficult to clean, dampen cloth with water and a mild liquid detergent. Make sure to remove any excess moisture.



#### Isopropyl Alcohol

Isopropyl vapors may cause a flash fire or explosion, and maybe harmful if inhaled. Vapors may cause severe eye irritation. Repeated or prolonged exposure may irritate mucous membranes.

- Clean external surfaces from dirt, grease, and fungus using a soft lint-free cloth dampened (not soaked) with Isopropyl alcohol.



- Clean ventilation housing openings using a blast of dry air and brush free from obstructing lint and dust. Dirt, dust and lint contribute to overheating of the CX300 Test Set causing poor ventilation, and malfunctioning.
- Inspect electrical connectors for bent, broken or missing electrical pins.
- Clean dirt, dust and lint from electrical connectors and cable connectors using a soft lint-free cloth and soft bristled brush.
- When not in use, cover the electrical or cable connectors using a non-metallic dust cover preventing tarnishing of connector contacts.

## 8.4 Charging the Battery

The CX300 is designed to be powered by two internal batteries or by an external AC power supply. The two internal batteries supports up to 2.5 hours of continuous operation, after which time the battery needs recharging.

### *To Recharge the Battery*

1. Connect the AC Power Adapter/Cord to the test set.
2. Connect the cord to a grounded AC power supply.
3. Verify the device's **Power Button/LED** turns amber to indicate the batteries is charging.
4. The **Power Button/LED** turns and stays green when the battery is fully charged.

## 8.5 Battery Replacement

### 8.5.1 Battery Part Information



#### WARNING

The two batteries supplied with the device should only be replaced with a VIAVI approved replacement part.

**Table 8-1 Battery Replacement Part Number**

Part Number	Description
22116266	Rechargeable Lithium Ion Battery



#### WARNING

A Lithium batteries is used in this equipment. Lithium is a toxic substance.

- Do not crush, incinerate or dispose of in normal waste.
- Do not short circuit or force discharge since this might cause the battery to vent, overheat or explode.

#### WEEE and Battery Statement

This product and the batteries used to power the product, should not be disposed of as unsorted municipal waste and should be collected separately and disposed of according to local regulations.

VIAVI has established a take-back processes in compliance with the EU Waste Electrical and Electronic Equipment (WEEE) Directive, 2012/19/EU, and the EU Battery Directive, 2006/66/EC.

Information and instructions for returning waste equipment and batteries to VIAVI can be found on the VIAV website in the WEEE section of VIAVI's Standards and Policies web page at: [VIAVI's Standards and Policies](#) web page.

### 8.5.2 Battery Removal

The following procedure describes how to remove the batteries.

#### ***To Remove the two Batteries.***



#### NOTE

VIAVI recommends powering down the device to replace the two batteries. However, if the batteries needs to be replaced during a test, the device can remain operational while connected to an AC Power Supply.

1. Place the unit on a work bench with the display facing up.
2. Loosen the thumbscrew securing the battery door cover. Slide battery door cover off.

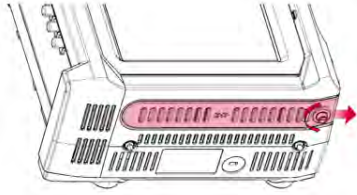

**Figure 8-1 Battery Door Cover Thumbscrew**

3. Remove battery/batteries.
  - If replacing a battery, proceed to the [“Battery Installation”](#).
  - If the device will be used without a batteries installed, proceed to the next step.
4. Slide battery door cover into place.
5. Align the battery door cover with the grooves in the battery door.
6. Use the thumbscrew to secure the battery door cover. Hand tighten the thumbscrew.
7. Dispose of the old battery/batteries according to local regulations.

### 8.5.3 Battery Installation



#### **WARNING**

The batteries that came with the device is a Lithium Ion batteries. If batteries are replace are not installed correctly it may explode. Use care when installing the batteries to ensure the batteries is properly inserted into the device.

1. Remove the old batteries. [See section 8.5.2, “Battery Removal”, on page 8-6.](#)
2. Slide the replacement battery into the battery slot. The key feature should be on the back side of the battery. Keep the battery straight and level with the case opening.

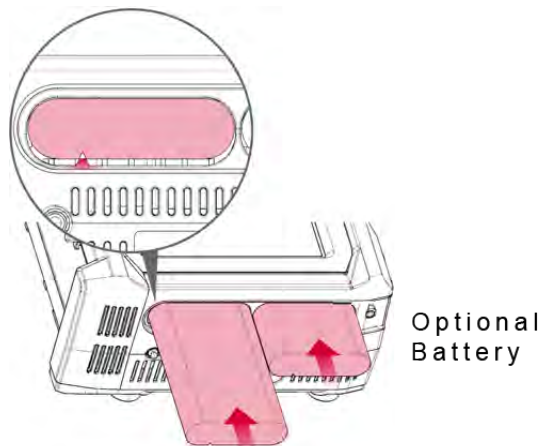

**Figure 8-2 Battery Installation Diagram**

3. When the battery engages the battery contacts, push the battery an additional 1/8" to 1/4" to fully seat the batteries. The battery “snaps” into position when the connector is fully seated.
4. Slide the battery door cover into place.
5. Align the battery door cover with the grooves in the battery door.
6. Use the thumbscrew to secure the battery door cover. Hand tighten the thumbscrew.
7. Dispose of the old battery according to local regulations.

## 8.6 Resetting the ComXpert Base

The instrument provides a reset function via the **Reset Button** located in the test set's side panel. The primary function of the **Reset Button** is to restore the device to a known configuration which allows the user to remotely connect to the unit via network interface.



### NOTE

The **Reset Button** is recessed and requires a small instrument like a paper clip to be activated. See [Figure 1-3 on page 1-10](#), for the location of the **Reset Button**.

Resetting the base unit performs the following functions:

- Disable firewall feature (port 22 only) if enabled.
- Disables VNC password if enabled.
- Set DHCP mode or set static IP addresses to the following defaults:
  - IP Address: 192.168.200.2
  - Subnet Mask: 255.255.255.0
  - Gateway: 192.168.200.1
  - DNS Address: 192.168.200.1

### **To Reset the ComXpert Base:**

Read this procedure in its entirety before proceeding.

1. Power down the unit.
2. After the unit has powered off, depress the **Reset** button and turn on the device.
3. When the message **Resetting to Default Setups** is displayed, release the **Reset** button.
4. After the message in step 3, a user prompt is displayed requiring the user to **Select Net Type:** and alternate between DHCP and Static IP. Quickly depressing and releasing the **Reset button** toggles between DHCP and Static IP settings.
5. Release the **Reset** button to select the displayed network type.

## 8.7 Updating Software

The test set is shipped from the factory with the operating system and firmware installed in the device. Regular checks should be performed to ensure the device contains the most current software, drivers, and or firmware. See [section 4.12, "Updating the System Software"](#), on [page 4-24](#) for software updating procedures.

## 8.8 CX300 ComXpert Self Test Procedure

The CX300 ComXpert has an automated Built-in-Test (BIT) procedure. The BIT is referred to as a Self Test. The CX300's Self Test evaluates the general functionality of the test set's generate and receive function, instruments and switches to ensure the device is operating properly.

See section 6.2, "CX300 Self Test Procedure", on page 6-4 for instructions to run the CX300 self test.

## 8.9 Troubleshooting Information

This sections lists malfunctions which may occur during normal device operation which are typically due to configuration errors. This section cannot list all configuration related malfunctions that may occur, nor all tests or inspections and corrective actions. Perform tests/inspections and corrective actions in order listed. If a malfunction is not listed, or is not corrected by the listed corrective actions, contact VIAVI Technical Assistance Center (TAC)

### 8.9.1 Troubleshooting Symptom Index

DESCRIPTION	PAGE
Device does not power on when operating on battery power.	8-11
Not receiving signal at RF Input or RF Duplex Connector.	8-11
No generator output at RF Output or RF Duplex Connector.	8-12
No input signal received at Audio Input Connector.	8-13
No signal output at AF Output Connector.	8-13
No input signal received on the Spectrum Analyzer.	8-14

## 8.9.2 Troubleshooting Guide

Table 8-2 Troubleshooting Guide (Sheet 1 of 4)

<b>Device does not power On when operating on battery power.</b>	
<b>1</b>	Are batteries charged? <ul style="list-style-type: none"><li>• Yes, proceed to next step.</li><li>• No, charge the battery.</li></ul>
<b>2</b>	Is battery is properly installed and seated in battery chamber? <ul style="list-style-type: none"><li>• No, reinstall battery. If problem persists, proceed to next step.</li><li>• Yes, contact TAC.</li></ul>
<b>3</b>	Does the test set power on when connected to an AC Power Supply? <ul style="list-style-type: none"><li>• No, contact TAC.</li><li>• Yes - probe cause of failure is old or defective battery. Contact TAC.</li></ul>
<b>Device does not power on when connected to an AC power supply.</b>	
<b>1</b>	Is the AC Power Adapter/power cord the approved part for the device? <ul style="list-style-type: none"><li>• No, use approved part. If problem persists, proceed to next step.</li><li>• Yes. proceed to next step.</li></ul>
<b>2</b>	Is AC Power Adapter/Cord securely connected to device and AC power supply? <ul style="list-style-type: none"><li>• No, secure AC Power Adapter/Cord. If problem persists, proceed to next step.</li><li>• Yes, proceed to next step.</li></ul>
<b>3</b>	Is AC Power Adapter/Cord correct rated power supply? <ul style="list-style-type: none"><li>• No, connect to correct power supply. If problem persists, proceed to next step.</li><li>• Yes, proceed to next step.</li></ul>
<b>4</b>	If a charged, CX300 lithium battery is available, Install battery in the test set. Does the test set power on?: <ul style="list-style-type: none"><li>• Yes, probable cause is failure at DC Input connector, contact TAC.</li><li>• No, contact TAC.</li></ul>
<b>Not receiving signal at RF Input or RF Duplex Connector.</b>	
<b>1</b>	Is test set Receiver Port set to connect input (RF Input or DF Duplex)?

**Table 8-2 Troubleshooting Guide (Continued) (Sheet 2 of 4)**

	<ul style="list-style-type: none"><li>• No, set Receiver Port to correct input. If problem persists, proceed to next step.</li><li>• Yes, proceed to next step.</li></ul>
<b>2</b>	Is cable properly connected to selected connector (RF Input or RF Duplex)? <ul style="list-style-type: none"><li>• No, properly connect cable. If problem persists, proceed to next step.</li><li>• Yes, proceed to next step.</li></ul>
<b>3</b>	Is the Receiver Frequency to correct frequency? <ul style="list-style-type: none"><li>• No, set Receiver Frequency to correct frequency. If problem persists, proceed to next step.</li><li>• Yes, proceed to next step.</li></ul>
<b>4</b>	Is test set Receiver Bandwidth set appropriately for input signal type? <ul style="list-style-type: none"><li>• No, set Bandwidth correctly. If problem persists, proceed to next step.</li><li>• Yes, proceed to next step.</li></ul>
<b>5</b>	Is test set Receiver Reference Level set appropriately for the input signal? <ul style="list-style-type: none"><li>• No, set Receiver Reference Level correctly. If problem persists, proceed to next step.</li><li>• Yes, proceed to next step.</li></ul>
<b>6</b>	Is Frequency Reference set to Internal? <ul style="list-style-type: none"><li>• Yes, remove any external source connected to the REF Output Connector. If Problem persists, proceed to next step.</li><li>• Yes, proceed to next step.</li></ul>
<b>7</b>	Is Frequency Reference set to Internal? <ul style="list-style-type: none"><li>• No, connect a valid external Reference. If Problem persists, proceed to next step.</li><li>• Yes, proceed to next step.</li></ul>
<b>8</b>	Is the correct external reference source selected (System > Clock Source)? <ul style="list-style-type: none"><li>• No, select correct external reference source. If problem persists, contact TAC.</li><li>• Yes, contact TAC.</li></ul>
<b>No generator output at RF Output or RF Duplex Connector.</b>	
<b>1</b>	Is correct output connector. If problem persists, proceed to next step.



**Table 8-2 Troubleshooting Guide (Continued) (Sheet 3 of 4)**

	<ul style="list-style-type: none"><li>• No, select correct output connector. If problem persists, proceed to next step.</li><li>• Yes, proceed to next step.</li></ul>
<b>2</b>	<b>Is RF Generator output turned ON?</b> <ul style="list-style-type: none"><li>• No, turn on RE Generator output. If problem persists, proceed to next step.</li><li>• Yes, proceed to next step</li></ul>
<b>3</b>	<b>Is Generator Frequency set to correct frequency?</b> <ul style="list-style-type: none"><li>• No, set RF Generator Frequency set to correct frequency?</li><li>• Yes, proceed to next step</li></ul>
<b>4</b>	<b>Is RF Generator level set appropriately for UUT?</b> <ul style="list-style-type: none"><li>• No, set RF Generator level to correct setting. If problem persists, contact TAC.</li><li>• Yes, contact TAC.</li></ul>

**No input signal received at Audio Input Connector.**

<b>1</b>	<b>Is input cable properly connected to Audio Input Connector?</b> <ul style="list-style-type: none"><li>• No, properly connect the cable. If problem persists, proceed to next step.</li><li>• Yes, contact TAC.</li></ul>
<b>2</b>	<b>Is the Audio Input Connector to which the input cable is connected selected as the Audio Input source (Audio Input 1 or Audio Input 2)?</b> <ul style="list-style-type: none"><li>• Yes, proceed to next step</li></ul>
<b>3</b>	<b>Are Audio in settings appropriate for the characteristics of the incoming audio signal (e.g. Range, Coupling)?</b> <ul style="list-style-type: none"><li>• No, adjust settings. If problem persists, contact TAC.</li><li>• Yes, contact TAC.</li></ul>

**No signal output at AF Output Connector.**

<b>1</b>	<b>Is CX300 AF Generator enabled?</b> <ul style="list-style-type: none"><li>• No, turn on AF Generator. If problem persists, proceed to next step.</li><li>• Yes, proceed to next step.</li></ul>
<b>2</b>	<b>Is RF input connector to which the input cable is connected selected as the Spectrum Analyzer Input source?</b>

**Table 8-2 Troubleshooting Guide (Continued) (Sheet 4 of 4)**

- No, select correct input connector. If persists, proceed to next step.
- Yes, proceed to next step.

**3** Is UUT properly configured to receive signal?

- No, correct UUT configuration. If problem persists, contact TAC.
- Yes, contact TAC.

**No input signal received on the Spectrum Analyzer.**

**1** Is input cable properly connected to RF Input or RF Duplex Connector?

- No, properly connect the cable. If problem persists, proceed to next step.
- Yes, proceed to next step.

**2** Is the RF input connector to which the input cable is connected selected as the Spectrum Analyzer Input source?

- No, select correct input connector. If problem persists, proceed to next step.
- Yes, proceed to next step.

**3** Are RBW and Span settings set to values that provide optimal sweep time?

- No, adjust settings to obtain optimal sweep time. If problem persists, proceed to next step.
  - Yes, contact TAC.
-

# CX300 ComXpert Specifications

This section contains specifications for standard CX300 ComXpert Communications Service Monitor. Refer to the CX300 ComXpert product data sheet for the full performance specifications.

- [Power Specifications](#) . . . . . A-2
- [Environmental Specifications](#) . . . . . A-4
- [Weights, Dimensions, and Fans](#) . . . . . A-5
- [Compliance and Safety Standards](#) . . . . . A-5

## A.1 Power Specifications

**Table A-1 Electrical Specifications**

Parameter	Specification
<b>Input</b>	VAC, 50/60 Hz, Switch Selectable
<b>Input Current</b>	5 A @ 115 VAC, 3 A @ 230 VAC
<b>Maximum Output</b>	+5 VDC @ 25 A +12 VDC @ 9.5/14 A Peak -5 VDC @ 1 A -12 VDC @ 1 A
<b>Current Protection</b>	Short circuit protected with automatic recovery.
<b>Minimum Load</b>	3.0 A @ +5 V 0.5 A @ +12 V
<b>Aux Output Receptacle</b>	1 A @ 115 VAC 0.5 A @ 230 VAC

**Table A-2 Battery Specifications**

Parameter	Specification
<b>Type</b>	Lithium Ion
<b>Nominal Operating Voltage</b>	14.4 V
<b>Initial Rate Capacity</b>	≥6460 mAh (based on a CV charge of 16.8 V, ±50 mV, with a current limit of 3.0 Amp and a 1360 mA discharge to 10.00 V @ 25C, within 1 hour of charge).
<b>Charging Time</b>	>4.5 hours, 2 batteries, 100% charged
<b>Battery Lithium Ion</b>	435 grams, 1 each
<b>Operating Time</b>	2.3 hours typical with 2 batteries
<b>Charging Temperature</b>	0 to +45°C (32 to 113°F), ≤ 80% RH



**NOTE**

When charging, if temperature reaches >45°C, the battery ceases charging until temperature drops to ≤ 44C.

**Table A-2 Battery Specifications**

Parameter	Specification
<b>Discharge Temperature</b>	-20 to +60°C (-4 to +140°F), ≤ 80% RH
<b>Storage Temperature</b>	-20 to 60°C (-4 to 140°F), ≤80% RH Recommended storage conditions: low-humidity ≤80%RH, low-temperature <21°C (70°F) environment.

**Table A-3 AC/DC Power Adapter**

Parameter	Specification
<b>Input</b>	
Voltage	100-240 V
Frequency	~50-60 Hz
Current	2.2 A max
<b>Output</b>	
Voltage	19-27 V (±5%)
Current	15 A Max
<b>Protection</b>	
Over Voltage Protection	Vout *150% Max
Short Circuit Protection	Shut down
Over Current Protection	Iout *150%
Over Temperature Protection	Shut down

## A.2 Environmental Specifications

Table A-4 Environmental Specifications

Parameter	Specification
Storage Temperature	-40 to +71°C (batteries removed)
Warm-up Time	30 minutes (before performing alignment - <a href="#">See section 5.11, "Normalize", on page 5-51</a> ).
Operating Temperature	0°C to 50°C (battery removed)
Relative Humidity	95% RH (non-condensing)
Altitude	4600 meters (15092 feet)
Vibration	MIL-PRF-28800F, Class 3
Shock, functional	MIL-PRF-28800F
Bench handling	MIL-PRF-28800F, Class 3

## A.3 Weights, Dimensions, and Fans

**Table A-5 CX300 ComXpert Weight and Dimensions**

Parameter	Specification
Height	9.6" (24.4 cm)
Width	12.2" (31 cm)
Depth	6.1" (15.5 cm)
Weight	15 lbs (6.8 kg) without battery

**Table A-6 Cooling Fans**

Parameter	Specification
Power Supply Fan	27 CFM, 1 each
Card Cage	45 CFM, 2 each
Intake Filter	30 ppi, open Cell, Polyfoam, SIF 'Z' 8.20 x 4.5 x 0.25 inches

## A.4 Compliance and Safety Standards

**Table A-7 EMC Compliance Standards**

FCC 47 CFR, Part 15
EMC Directive 2014/30/EU
AZ/NZS CISPR 11
ICES/NMB-001
EN 61326-1:2013

**Table A-8 Safety Standards**

EN/IEC/UL 61010-1
CSA C22.2 No. 61010-1

This page intentionally left blank.



# Glossary

- A**
- A2D** — Analog to Digital
  - ACLR** — Adjacent Channel Leakage Power Ratio
  - AGC** — Automatic Gain Control
  - AM** — Amplitude Modulation
  - AF** — Audio Frequency
  - ANT** — Antenna
- B-C**
- BER** — Bit Error Rate
  - BPF** — Band Pass Filter
  - bps** — bits per second
  - BW** — Bandwidth
  - CW** — Carrier Waveform
- D**
- DST** — Daylight Savings Time
  - DTF** — Distance to Fault
- E - G**
- Ethernet TE** — Ethernet Throughput Efficiency
  - EVM** — Error Vector Magnitude
  - Ext** — External

**FM** — Frequency Modulation

**FFT** — Fast Fourier Transform

**GEN** — Generator

**GHZ** — giga hertz

**GPS** — Global Positioning Satellite

**GUI/UI** — Graphic User Interface/User Interface

**H - K**

**HZ** — Hertz

**I/O** — Input/Output

**IF** — Intermediate Frequency

**kbps** — kilo bits per second

**kHz** — kilo hertz

**L**

**LAN** — Local Area Network

**LCD** — Liquid Crystal Display

**LED** — Light Emitting Diode

**LIT** — Line Item Test

**LPF** — Low Pass Filter

**LRU** — Line Replaceable Unit

**LSB** — Lower Sideband

**M**

**mA** — mill Amp

**MHz** — Megahertz

**mHz** — millihertz

**Mod** — Modulation

**Mode of Operation** — Term used to refer to the combined test mode and measurement mode selected on a CX300 test screen.

**mW** — mill watt

---

<b>N - R</b>	<b>NRZ</b> — Non-return to Zero
	<b>NTP</b> — Network Time Protocol
	<b>OBW</b> — Occupied Bandwidth
	<b>PM</b> — Phase Modulation
	<b>RA/RMA</b> — Return Authorization/Return Material Authorization
	<b>RBW</b> — Resolution Bandwidth
	<b>Ref</b> — Reference
	<b>RF</b> — Radio Frequency
	<b>RMS</b> — Root Mean Square
	<b>Rx</b> — Receive
<b>S - T</b>	<b>SCA</b> — Software Communications Architecture
	<b>Spec</b> — Specifications
	<b>SSB</b> — Single Sideband
	<b>SWR</b> — Standing Wave Ratio
	<b>TCA</b> — Technical Assistance Center (customer support)
	<b>TPS</b> — Test Program Set
	<b>TR</b> — Transmit/Receive
	<b>Tx</b> — Transmit
<b>U - Z</b>	<b>USB</b> — Universal Service Bus
	<b>USB</b> — Upper Sideband
	<b>UUT</b> — Unit Under Test
	<b>V<sub>pp</sub></b> — Voltage peak-to-peak
	<b>V<sub>rms</sub></b> — Volts Root Mean Square
	<b>VSWR</b> — Voltage Standing Wave Ratio
	<b>W</b> — Watt

This page intentionally left blank.

# Index

<b>A</b>		<b>C</b>	
AC Power Operation	2-5	Channel Analyzer	
Accessories		Controls and Settings	5-53
Optional	2-4	Introduction	5-53
Standard	2-3	Charging the Battery	8-5
AF Counter		Compliance Standards	A-5
Audio	5-41	Cooling Fans	A-5
Demod	5-41	Creating a Report	7-4
AF Generator			
Configuring	5-20	<b>D</b>	
Controls and Settings	5-19	Date and Time Settings	3-12
Introduction	5-19	Demod Noise Meters	5-36
AF Level Meter	5-41	Digital Voltmeter	5-43
AM Depth Meter	5-32	Dimensions	A-5
Audio		Display	
Coupling	5-27	Brightness	3-14
Filters	5-26	Screen Saver	3-15
Input Controls and Settings	5-25	Distortion Meter	
Noise Meters	5-38	Audio	5-39
Signal Routing	5-42	Demod	5-37
Squelch	5-42	Duplex Test Mode	5-2
AutoTest Mode	5-71		
<b>B</b>		<b>E</b>	
Battery		Editing Parameters	2-16
AC Adapter/Charger	12	Electromagnetic Interference	16
Charging Indicator	3-10	Electrostatic Discharge	15
Disposal	8-6	EMI	16
Handling	8-6	Equipment Usage	15
Installation Procedure	8-7	Erasing Content	3-24
Operation	2-5	ESD	15
Power Save Mode	3-11	External Cleaning	8-4
Removal Procedure	8-6	External Storage	
Replacement	14	Accessing Files	3-3
Replacement Instructions	8-6		
Replacement Part	8-6		
Reserve Indicator	3-10		
Specifications	A-2		
Status Indicator	3-11		
Temperature	3-10		
Bluetooth Controls and Settings	3-4		

<b>F</b>	
File Management	3-2
Controls	7-5
Creating a Report	7-4
Event Setup	7-3
Introduction	7-2
Loading Files	7-4
Quick Save Setup	7-3
Saving Files	7-2
FM Deviation Meter	5-32
Forced Shutdown	2-7
Freight Costs	8-2
Frequency List	5-52
Frequency Reference	3-19
<b>G</b>	
GNSS	
Status Indicator	3-21
<b>H</b>	
How to	
Add a WiFi Network Profile	4-9
Capture Screen Shot	4-30
Enable Network Connectivity	4-5
Establishing a Ethernet connection	4-6
Establishing a WiFi Connection	4-9
Hum & Noise Meter	
Audio	5-40
Demod	5-37
<b>I</b>	
Input Overload	11
<b>L</b>	
LAN Controls and Settings	3-5
Loading Files	7-4
<b>M</b>	
Maintenance	
Battery Replacement Instructions	8-6
Charging the Battery	8-5
External Cleaning	8-4
Self Test Procedure	8-10
System Reset Procedure	8-9
Updating Software	8-9
Visuals Inspections	8-4
Manual	
Related Information	v
Scope	iii
Markers	
Adding (Viewing)	5-10
Deleting (Hiding)	5-12
How to Add	5-13
How to Create Delta	5-13
How to Delete	5-13
How to Position	5-13
Introduction	5-9
Marker Controls Toolbar	5-9
Marker Readings Panel	5-12
Measurement Type	5-10
Navigation Buttons	5-11
Positioning	5-10
Meters	
AF Counter	5-41
AF Level	5-41
AM Depth	5-32
Analog Demodulation	5-32
Audio Noise	5-38
Averaging	5-31
Demod Noise	5-36
Distortion (Audio)	5-39
Distortion (Demod)	5-37
DVM	5-43
FM Deviation	5-32
Hum & Noise (Audio)	5-40
Hum & Noise (Demod)	5-37
Limits	5-27
PM Deviation	5-32
Refresh Data	5-31
RF Counter	5-36
RF Error	5-35
RF Power	5-35
Scaling	5-31
SINAD (Audio)	5-39
SINAD (Demod)	5-36
SNR (Audio)	5-40
SNR (Demod)	5-37
SSB	5-32
Modulation Generator	
Configuring	5-19
Controls and Settings	5-17
Introduction	5-17
Multiple Measurement Tabs	5-9
<b>N</b>	
Network	
Certificates	3-8
Introduction	3-5
LAN Controls and Settings	3-5
WiFi Controls and Settings	3-8
Noise Meter	
Audio	5-38
Demod	5-36
Numeric Keypad	2-17
Numeric Slider	2-18
<b>O</b>	
Operation	
Remote Access	3-15
Optional Accessories	2-4
Oscilloscope	
Controls and Settings	5-58
Introduction	5-58

<b>P</b>	
Packing Procedure	8-3
PM Deviation Meter	5-32
Power	
Specifications	A-2
Power Management Screen	3-9
Powering Down Test Set	2-6
Powering the Test Set	2-4, 2-5
Battery Operation	2-5
Pre-Amplifier	5-23
Product Nomenclature	v
<b>Q</b>	
Quick Save Setup	7-3
<b>R</b>	
Rebooting Test Set	2-6
Remote Access	3-15
Return Material Authorization	8-2
RF Counter	5-36
RF Generator	
Configuring	5-16
Controls and Settings	5-15
Introduction	5-15
RF Power Meter	
Description	5-35
RF Receiver	
Configuring	5-24
Controls and Settings	5-22
Input Overload	5-21
Introduction	5-21
<b>S</b>	
Safety	
AC Power Adapter	12
Electrical Hazards	11
Input Overload	11
Symbols and Markings	7
Toxic Hazards	8
Ventilation	16
Safety Standards	A-5
Save to Event Setup	7-3
Saving Files	7-2
Screen Saver	3-15
Self Test Procedure	8-10
Serial Number	3-24
Shipping	
Containers	8-2
Instructions	8-2
SINAD Meter	
Audio	5-39
Demod	5-36
Single Side-band Meter	5-32
SNR Meter	
Audio	5-40
Demod	5-37
Software Version	3-24
Specifications	
AC/DC Power Adapter	A-3
Battery	A-2
Compliance Standards	A-5
Dimensions	A-5
Electrical	A-2
Environmental	A-4
Power	A-2
Safety Standards	A-5
Weight	A-5
Spectrum Analyzer	
Amplitude and Scale	5-61
Bandwidth	5-63
Controls and Settings	5-60
Frequency	5-60
I/O Controls	5-70
Introduction	5-60
Measurements	5-69
Span	5-60
Sweep	5-68
Trace	5-65
Triggers	5-68
Spectrum Analyzer Mode	5-2
SSB Meter	5-32
Standard Accessories	2-3
System Info	
Serial Numbers	3-24
Software Options	3-25
Software Version	3-24
System Screens	
Accessing	2-8
Audio Controls	3-19
Bluetooth	3-4
Clock Source	3-19
Date and Time	3-12
Display	3-14
Files	3-2
GNSS	3-20
Network	3-5
Power Management	3-9
Region	3-14
Remote	3-15
Removable Storage	3-3
StrataSync	3-25
Test Set Loci	3-18
Upgrade	3-17
Video Player	3-26
Web Browser	3-26
<b>T</b>	
Technical Assistance	
Contact Information	4, v
RMA/RA	8-2
Shipping Containers	8-2
Shipping Instructions	8-2
Tagging Equipment	8-2
Test and Measurements	
AM Transmitter Testing	6-11
Channel Power Measurements	6-19
FM Receiver Performance Test	6-15

FM Transmitter Testing .....	6-6	Numeric Slider .....	2-18
Home Screen .....	5-3	Operation .....	2-15
RF Connection Configurations .....	6-2	Screen Layout .....	2-11
Screen Overview .....	5-3	Selecting Parameters .....	2-16
Self Test .....	6-4	Test Controls Toolbar .....	5-7
Test Mode Screens .....	5-5	UI Keyboard .....	2-20
Test Functions		Unpacking Equipment .....	2-2
How to Access .....	5-14	Updating Software .....	8-9
Test Modes .....	5-2	Upgrading the Test Set .....	3-17
Timing Reference .....	3-19	Upon Receipt	
Tone Decoding .....	5-44	Battery Inspection .....	2-3
Tone Encoding		Inspecting Equipment .....	2-2
CTCSS .....	5-48	Preparing for First Use .....	2-4
DCS .....	5-47	Unpacking Equipment .....	2-2
DTMF .....	5-46	Verify Shipment .....	2-3
Generating Encoded Signal .....	5-50	User Interface	
Introduction .....	5-45	Screen Layout .....	2-10
Source .....	5-45	Test and System Screen Layout .....	2-11
Tone Remote .....	5-48		
Tone Sequential .....	5-49	<b>V</b>	
Two Tone Sequential .....	5-49	Ventilation Requirements .....	16
Type .....	5-45	Verify Test Set Operation .....	2-7
Transmitter Test Mode .....	5-2	Video Player .....	3-26
Troubleshooting Information .....	8-10	Visual Inspections .....	8-4
Turning On Test Set .....	2-6		
		<b>W</b>	
<b>U</b>		Web Browser .....	3-26
UI		Weight .....	A-5
Editing Parameters .....	2-16	WiFi Controls and Settings .....	3-8
Keyboard .....	2-20		
Multiple Measurement Tabs .....	5-9		
Navigation .....	2-15		
Numeric Keypad .....	2-17		



---

This page intentionally left blank.



## **CX300 Operation Manual**

**22130634 Rev. 003**

**September, 2022**

**English**

### **VIAVI Solutions**

**North America: 1.844.GO VIAVI / 1.844.468.4284**

**Latin America +52 55 5543 6644**

**EMEA +49 7121 862273**

**APAC +1 512 201 6534**

**All Other Regions: [viavisolutions.com/contacts](https://www.viavisolutions.com/contacts)**