



ALT-8000
Radio Altimeter
Flight Line Test Set
Operation Manual



ALT-8000

Radio Altimeter Flight-line Test Set

Operation Manual

PUBLISHED BY
VIAVI Solutions, Inc.

COPYRIGHT © VIAVI Solutions, Inc. 2020

All rights reserved. No part of this publication may be reproduced, stored in a retrieval system, or transmitted in any form or by any means, electronic, mechanical, photocopying, recording or otherwise without the prior permission of the publisher.

Original Issue	Jun 2011
Re-issued	June 2020

ELECTROMAGNETIC COMPATIBILITY

Double shielded and properly terminated external interface cables must be used with this equipment when interfacing with the RS-232 and Ethernet.

For continued EMC compliance, all external cables must be shielded and 3 meters or less in length.

NOMENCLATURE STATEMENT

In this manual, ALT-8000, Simulator, Test Set or Unit refers to the ALT-8000 Radio Altimeter Flight Line Test Set.

THIS PAGE INTENTIONALLY LEFT BLANK.

Declaration of Conformity

The Declaration of Conformity Certificate included with the Unit should remain with the Unit.

VIAVI recommends the operator reproduce a copy of the Declaration of Conformity Certificate to be stored with the Operation Manual for future reference.

THIS PAGE INTENTIONALLY LEFT BLANK.

Precautions

SAFETY FIRST - TO ALL OPERATIONS PERSONNEL

GENERAL CONDITIONS OF USE

This product is designed and tested to comply with the requirements of IEC/EN61010-1 'Safety requirements for electrical equipment for measurement, control and laboratory use' for Class I portable equipment and is for use in a pollution degree 2 environment. The equipment is designed to operate from installation supply Category II.

Equipment should be protected from liquids such as spills, leaks, etc. and precipitation such as rain, snow, etc. When moving the equipment from a cold to hot environment, allow the temperature of the equipment to stabilize before the equipment is connected to the supply to avoid condensation forming.

The equipment must only be operated within the environmental conditions specified in the performance data.

CASE, COVER OR PANEL REMOVAL





Opening the Case Assembly exposes the operator to electrical hazards that may result in electrical shock or equipment damage. Do not operate this Test Set with the Case Assembly open.

SAFETY IDENTIFICATION IN TECHNICAL MANUAL

This manual uses the following terms to draw attention to possible safety hazards that may exist when operating or servicing this equipment:

CAUTION	IDENTIFIES CONDITIONS OR ACTIVITIES THAT, IF IGNORED, CAN RESULT IN EQUIPMENT OR PROPERTY DAMAGE, E.G., FIRE.
WARNING	IDENTIFIES CONDITIONS OR ACTIVITIES THAT, IF IGNORED, CAN RESULT IN PERSONAL INJURY OR DEATH.

SAFETY SYMBOLS IN MANUALS AND ON UNITS

	CAUTION: Refer to accompanying documents. (This symbol refers to specific CAUTIONS represented on the unit and clarified in the text.)
	Indicates a Toxic hazard.
	Indicates item is static sensitive.
	AC TERMINAL: Terminal that may supply or be supplied with AC or alternating voltage.

SAFETY FIRST - TO ALL OPERATIONS PERSONNEL (cont)

EQUIPMENT GROUNDING PROTECTION

Improper grounding of equipment can result in electrical shock.

USE OF PROBES

Refer to Performance Specifications for the maximum voltage, current and power ratings of any connector on the Test Set before connecting a probe from a terminal device. Be sure the terminal device performs within these specifications before using the probe for measurement, to prevent electrical shock or damage to the equipment.

POWER CORDS

Power cords must not be frayed or broken, nor expose bare wiring when operating this equipment.

USE RECOMMENDED FUSES ONLY

Use only fuses specifically recommended for the equipment at the specified current and voltage ratings. Refer to Performance Specifications for fuse requirements and specifications.

INTERNAL BATTERY



This unit contains a Lithium Ion Battery, serviceable only by a qualified technician.

EMI (ELECTROMAGNETIC INTERFERENCE)

CAUTION	SIGNAL GENERATORS CAN BE A SOURCE OF ELECTROMAGNETIC INTERFERENCE (EMI) TO COMMUNICATION RECEIVERS. SOME TRANSMITTED SIGNALS CAN CAUSE DISRUPTION AND INTERFERENCE TO COMMUNICATION SERVICE OUT TO A DISTANCE OF SEVERAL MILES. USER OF THIS EQUIPMENT SHOULD SCRUTINIZE ANY OPERATION THAT RESULTS IN RADIATION OF A SIGNAL (DIRECTLY OR INDIRECTLY) AND SHOULD TAKE NECESSARY PRECAUTIONS TO AVOID POTENTIAL COMMUNICATION INTERFERENCE PROBLEMS.
----------------	--

SAFETY FIRST - TO ALL OPERATIONS PERSONNEL (cont)

TOXIC HAZARDS

<p>WARNING</p>	<p>SOME OF THE COMPONENTS USED IN THIS EQUIPMENT MAY INCLUDE RESINS AND OTHER MATERIALS WHICH GIVE OFF TOXIC FUMES IF INCINERATED. TAKE APPROPRIATE PRECAUTIONS IN THE DISPOSAL OF THESE ITEMS.</p>
	<p>BERYLLIA</p>
<p>WARNING</p>	<p>BERYLLIA (BERYLLIUM OXIDE) IS USED IN THE CONSTRUCTION OF SOME OF THE COMPONENTS IN THIS EQUIPMENT.</p> <p>THIS MATERIAL, WHEN IN THE FORM OF FINE DUST OR VAPOR AND INHALED INTO THE LUNGS, CAN CAUSE A RESPIRATORY DISEASE. IN ITS SOLID FORM, AS USED HERE, IT CAN BE HANDLED SAFELY, HOWEVER, AVOID HANDLING CONDITIONS WHICH PROMOTE DUST FORMATION BY SURFACE ABRASION.</p> <p>USE CARE WHEN REMOVING AND DISPOSING OF THESE COMPONENTS. DO NOT PUT THEM IN THE GENERAL INDUSTRIAL OR DOMESTIC WASTE OR DISPATCH THEM BY POST. THEY SHOULD BE SEPARATELY AND SECURELY PACKED AND CLEARLY IDENTIFIED TO SHOW THE NATURE OF THE HAZARD AND THEN DISPOSED OF IN A SAFE MANNER BY AN AUTHORIZED TOXIC WASTE CONTRACTOR.</p>
	<p>BERYLLIUM COPPER</p>
<p>WARNING</p>	<p>SOME MECHANICAL COMPONENTS WITHIN THIS INSTRUMENT ARE MANUFACTURED FROM BERYLLIUM COPPER. THIS IS AN ALLOY WITH A BERYLLIUM CONTENT OF APPROXIMATELY 5%. IT REPRESENTS NO RISK IN NORMAL USE.</p> <p>THE MATERIAL SHOULD NOT BE MACHINED, WELDED OR SUBJECTED TO ANY PROCESS WHERE HEAT IS INVOLVED.</p> <p>IT MUST BE DISPOSED OF AS "SPECIAL WASTE."</p> <p>IT MUST NOT BE DISPOSED OF BY INCINERATION.</p>
	<p>LITHIUM</p>
<p>WARNING</p>	<p>A LITHIUM BATTERY IS USED IN THIS EQUIPMENT.</p> <p>LITHIUM IS A TOXIC SUBSTANCE SO THE BATTERY SHOULD IN NO CIRCUMSTANCES BE CRUSHED, INCINERATED OR DISPOSED OF IN NORMAL WASTE.</p> <p>DO NOT ATTEMPT TO RECHARGE THIS TYPE OF BATTERY. DO NOT SHORT CIRCUIT OR FORCE DISCHARGE SINCE THIS MIGHT CAUSE THE BATTERY TO VENT, OVERHEAT OR EXPLODE.</p>

SAFETY FIRST - TO ALL OPERATIONS PERSONNEL (cont)

FIRE HAZARD

WARNING

MAKE SURE THAT ONLY FUSES OF THE CORRECT RATING AND TYPE ARE USED FOR REPLACEMENT. IF AN INTEGRALLY FUSED PLUG IS USED ON THE SUPPLY LEAD, ENSURE THAT THE FUSE RATING IS COMMENSURATE WITH THE CURRENT REQUIREMENTS OF THIS EQUIPMENT.

INPUT OVERLOAD

CAUTION

UUT:RX PORT MAXIMUM REVERSE POWER
100 mW

OLDER TEST SETS HAVE THE UUT:RX PORT LABELED AS TX PORT.

CAUTION

UUT:TX PORT MAXIMUM POWER 300 W PEAK,
5 W AVERAGE

OLDER TEST SETS HAVE THE UUT:TX PORT LABELED AS RX PORT.

STATIC SENSITIVE COMPONENTS



This equipment contains components sensitive to damage by Electrostatic Discharge (ESD). All personnel performing maintenance or calibration procedures should have knowledge of accepted ESD practices and/or be ESD certified.

RoHS Product Information for People's Republic of China

TOXIC OR HAZARDOUS SUBSTANCE CONTENT TABLE

The table provided below lists information as required by People's Republic of China Electronic Industry Standard SJ/T11364-2006, Marking for Control of Pollution Caused by Electronic Information Products. The table lists toxic or hazardous substances contained in VIAVI products that exceed limits in SJ/T11364-2006.

Parts 部件名称	Toxic or Hazardous Substances 有毒或有害物质					
	Lead (Pb) 铅	Mercury (Hg) 汞	Cadmium (Cd) 镉	Hexavalent Chromium (Cr6+) 六价铬	Polybrominated Biphenyls (PBB) 多溴联苯	Polybrominated Diphenyl Ethers (PBDE) 多溴二苯醚
Printed Board Assemblies 印刷电路板组件	X	O	O	O	O	O
Chassis Subassembly 机箱子组件	O	O	O	O	O	O
Power Supply 电源	X	O	O	O	O	O
Cable & Cable Assemblies 电缆及电缆组件	X	O	O	O	O	O
O:	Indicates that the toxic or hazardous substance contained in all of the homogenous materials for this component is below the limit requirement in SJ/T11363-2006					
O:	表示在此组件的所有均质材料中的有毒有害物质低于 SJ/T11363-2006 规定的限量要求					
X:	Indicates that the toxic or hazardous substance contained in at least one of the homogenous materials for this component is above the limit requirement in SJ/T11363-2006					
X:	表示至少一个此组件的均质材料中的有毒有害物质高于 SJ/T11363-2006 规定的限量要求					

THIS PAGE INTENTIONALLY LEFT BLANK.

Preface

SCOPE

This Manual contains instructions for operating the ALT-8000. The Operator should become thoroughly familiar with this manual before attempting to operate the equipment.

ORGANIZATION

This manual is composed of the following chapters:

CHAPTER 1 - DESCRIPTION

Provides an introduction and a brief overview of Test Set functions and features.

CHAPTER 2 - TEST SET OPERATION

Identifies Test Set Controls, Connectors and Indicators.

Provides Power On and Power Off procedures.

Provides functional description of Graphic User Interface (GUI) components.

Provides instructions for defining Test Set parameters.

CHAPTER 3 - TEST SET FUNCTIONS

Provides functional description of Test Set functions.

CHAPTER 4 - TESTING

Provides ALT-8000 test guidelines.

CHAPTER 5 - MAINTENANCE

Identifies Operator Level Troubleshooting and Maintenance procedures.

CHAPTER 6 - PRINCIPLES OF OPERATION

Provides information regarding Test Set principles of operation.

CHAPTER 7 - SPECIFICATIONS

Identifies Test Set specifications.

APPENDIX A - PIN-OUT TABLES

Identifies connector pin locations.

APPENDIX B - TERMINOLOGY

Lists terms and abbreviations used in this manual.

THIS PAGE INTENTIONALLY LEFT BLANK.

Service Upon Receipt of Material

UNPACKING TEST SET

Special design packing material inside this shipping container provides maximum protection for the Test Set. Avoid damaging the shipping container and packaging material when unpacking equipment. The shipping container and packaging material can be reused to ship the Test Set if necessary.

Use the following steps to unpack the Test Set:

STEP	PROCEDURE
1.	Cut and remove sealing tape on top of the shipping container. Open shipping container and remove top packing mold.
2.	Grasp the Test Set firmly while restraining the shipping container. Lift the equipment and packing material vertically out of the shipping container.
3.	Place Test Set and end cap packing on a flat, clean and dry surface.
4.	Remove protective plastic bag from the Test Set.
5.	Place protective plastic bag and end cap packing materials inside shipping container.
6.	Store shipping container for possible future use.

CHECKING UNPACKED EQUIPMENT

Inspect equipment for possible damage incurred during shipment. If Test Set has been damaged, report the damage to VIAVI Customer Service.

Review packing slip to verify shipment is complete. Packing slip identifies the standard items as well as purchased options. Report all discrepancies to VIAVI.

Contact:

VIAVI	
	Customer Service Dept.
	10200 West York Street
	Wichita, Kansas 67215
Telephone:	800-835-2350
FAX:	316-529-5330
email:	AvComm.Service@viavisolutions.com

Standard Items

ITEM		PART NUMBER	QTY
ALT-8000 Test Set		87340	1
Transit Case		88494	1
Power Supply		67374	1
Jumper Coax Cable, 1 ft		62401	1
Connector, TNC		38353	2
Antenna Coupler		139139	2
Antenna Coupler Pole Kit		139152	2
Antenna Coupler Labels		111838	1

ITEM		PART NUMBER	QTY
Attenuator, fixed 20dB		112036	1
Coax Cable, Low Loss RF, Yellow, 20 ft		88511	1
Coax Cable, Low Loss RF, Red, 20 ft		89527	1
Power Cord, US		62302	1
Power Cord, European		64020	1
Operation Manual (CD)		88035	1
Getting Started (paper)		88036	1

Optional Items

ITEM		PART NUMBER	QTY
Battery Pack		86196	1
Coax Cable, RG400 TNC-TNC, yellow (4 ft)		91253	1
Coax Cable, RG400 TNC-TNC, red (4 ft)		91255	1
Soft Case with Low Loss RF Cable (100 ft)		88500	1
Maintenance Manual (CD)		89022	1

Table of Contents

Chapter 1 - Description 1 - 1

Introduction ALT-8000	1 - 1
Scope	1 - 1
Nomenclature Cross-Reference List	1 - 1
Equipment Capabilities and Features	1 - 1
Capabilities	1 - 2
Features	1 - 2
Utilities	1 - 2

Chapter 2 - Test Set Operation 2 - 1

Introduction	2 - 1
Power Requirements	2 - 1
Power	2 - 1
Battery Recharging Using External Power Supply	2 - 2
Installation	2 - 2
Ventilation Requirements	2 - 2
Bench Top Installation	2 - 2
Controls and Connectors	2 - 3
Front Panel Controls	2 - 3
Rear Panel Connectors	2 - 5
Operating Procedures	2 - 6
Power ON Test Set	2 - 6
Power OFF Test Set	2 - 6
User Interface Components	2 - 7
Launch Bar	2 - 7
Function Keys	2 - 8
Simulation Function Windows	2 - 9
Function Window Icons	2 - 10
Defining Parameters	2 - 11
Entering Numeric Values	2 - 11
Numeric Keypad and Slider Bar	2 - 11
Data Slew Bar	2 - 12
Rotary Knob	2 - 12
Drop-down Menus	2 - 12
Selectable Units	2 - 13
Locked Fields	2 - 13

Chapter 3 - Test Set Functions 3 - 1

Introduction	3 - 1
Test Set Functions	3 - 1
Simulation Function Window	3 - 1
Profile Setup Function Window	3 - 5
Test Setup	3 - 11
Test Setup Function Window	3 - 11
Self Test Function Window	3 - 19
Status Bar Alert Messages	3 - 21

Chapter 4 - Testing 4 - 1

Introduction	4 - 1
Antenna Couplers and Installation Kit	4 - 1
Testing Pulse Type Altimeters with the 20dB Attenuator	4 - 3
Direct Connection	4 - 3
Antenna Coupler Installation and Connection	4 - 4
Feeder Connection	4 - 5
Setup	4 - 6
Identifying Installed Software Version	4 - 17

Chapter 5 - Maintenance 5 - 1

Introduction	5 - 1
Visual Inspections	5 - 1
External Cleaning	5 - 1
Maintenance Procedures	5 - 2
Battery Replacement	5 - 2
ALT-8000 Software Update	5 - 3
System Configuration Function Window	5 - 4
Maintenance Function Window	5 - 8
Diagnostics Function	5 - 9
System Info Function Window	5 - 14

Chapter 6 - Principles of Operation 6 - 1

Principles of Operation	6 - 1
ALT-8000 Test Operation	6 - 1
Radio Altimeters	6 - 2
FM/CW Radio Altimeter	6 - 3
Pulse Radio Altimeter Systems	6 - 10
Systems Coupled With Radio Altimeter	6 - 12

Chapter 7 - Product Specifications7 - 1

User Interface	7 - 1
Generator (UUT:RX)	7 - 1
Receiver (UUT:TX)	7 - 2
Master Oscillator	7 - 3
Reliability	7 - 3
Coupler	7 - 3
Battery	7 - 4
Physical Characteristics	7 - 4
Environmental	7 - 4

Appendix A - Pin-Out TablesA - 1

ETHERNET CONNECTOR	A - 1
USB HOST 1 CONNECTOR	A - 1
USB HOST 2 CONNECTOR	A - 2
USB OTG CONNECTOR	A - 2
DC POWER CONNECTOR	A - 2
AUX CONNECTOR	A - 2

Appendix B - TerminologyB - 1

THIS PAGE INTENTIONALLY LEFT BLANK.

List of Figures

TITLE	PAGE
Fig. 1-1 VIAVI ALT-8000	1 - 1
Fig. 2-1 AC Adapter	2 - 1
Fig. 2-2 Front Panel Controls	2 - 3
Fig. 2-3 Test Set Rear Panel Controls and Connectors	2 - 5
Fig. 2-4 Launch Bar - Open/Close Tab	2 - 7
Fig. 2-5 Launch Bar Appears In Front of Function Window	2 - 7
Fig. 2-6 Launch Bar Function Keys	2 - 8
Fig. 2-7 Simulation Function Window	2 - 9
Fig. 2-8 Numeric Keypad	2 - 11
Fig. 2-9 Data Slew Bar	2 - 12
Fig. 2-10 Rotary Knob	2 - 12
Fig. 2-11 Drop-down Menu	2 - 12
Fig. 2-12 Selectable Units	2 - 13
Fig. 2-13 Locked Field	2 - 13
Fig. 3-1 Simulation Function Window (Simulation: Manual)	3 - 1
Fig. 3-2 Simulation Function Window (Simulation: Profile)	3 - 2
Fig. 3-3 Radio Altimeter Test Function Window Pulse	3 - 4
Fig. 3-4 Profile Setup Function Window	3 - 5
Fig. 3-5 Edit Leg # Window	3 - 7
Fig. 3-6 Manage Profiles Window (Store Profile)	3 - 8
Fig. 3-7 Manage Profiles Window (Store Name Entry)	3 - 8
Fig. 3-8 Manage Profiles Window (Delete Profile)	3 - 9
Fig. 3-9 Load Profile Window	3 - 10
Fig. 3-10 General Tab Screen	3 - 11
Fig. 3-11 Loss Tab Screen	3 - 13
Fig. 3-12 Storage Tab Window	3 - 14
Fig. 3-13 Manage Settings Window (Store Settings)	3 - 15
Fig. 3-14 Manage Settings Window (Store Name Entry)	3 - 15
Fig. 3-15 Manage Settings Window (Delete Settings)	3 - 16
Fig. 3-16 Load Settings Window (Recall Settings)	3 - 16
Fig. 3-17 Storage Tab Window (Factory Reset)	3 - 17
Fig. 3-18 Display Tab Window	3 - 18
Fig. 3-19 Self Test Screen	3 - 19
Fig. 3-20 Self Test Running	3 - 19
Fig. 3-21 Self Test Passed	3 - 20
Fig. 3-22 Status Bar	3 - 21
Fig. 3-23 Alert Message Log	3 - 21

Fig. 4-1	ALT-8000 Antenna Coupler	4 - 1
Fig. 4-2	Pole #1	4 - 1
Fig. 4-3	Extension Pole #2	4 - 2
Fig. 4-4	Extension Pole #3	4 - 2
Fig. 4-5	Extension Pole #4	4 - 2
Fig. 4-6	Low Loss RF Coax Cable, 20 ft.	4 - 2
Fig. 4-7	Jumper RF Coax Cable	4 - 2
Fig. 4-8	Attenuator, fixed 20 dB	4 - 2
Fig. 4-9	Direct Connection	4 - 3
Fig. 4-10	ALT-8000 RF Connections	4 - 4
Fig. 4-11	ALT-8000 RF Connections (Feeders).	4 - 5
Fig. 4-12	ALT-8000 Antenna Coupler Installed	4 - 5
Fig. 4-13	Delay Calibration Screen	4 - 7
Fig. 4-14	Altitude Indicator Zero Screen	4 - 7
Fig. 4-15	Altitude Indicator Zero Procedure Screen	4 - 8
Fig. 4-16	Altitude Pause Key	4 - 9
Fig. 4-17	Paused Altitude Rate / Manual Altitude Slew	4 - 10
Fig. 4-18	Multi-leg Profile Example	4 - 12
Fig. 4-19	UUT Parameters (part of the Simulation Function Window)	4 - 15
Fig. 4-20	Options Function Window	4 - 18
Fig. 5-1	Battery Replacement	5 - 2
Fig. 5-2	USB Ports	5 - 3
Fig. 5-3	System Configuration - Status	5 - 4
Fig. 5-4	System Configuration - Hardware	5 - 5
Fig. 5-5	System Configuration – UI Options	5 - 6
Fig. 5-6	System Configuration – Network	5 - 7
Fig. 5-7	System Configuration – Date/Time	5 - 8
Fig. 5-8	Maintenance Function Window	5 - 8
Fig. 5-9	Transmit Function	5 - 9
Fig. 5-10	Receive Diagnostics	5 - 10
Fig. 5-11	Tx Attens Screen	5 - 11
Fig. 5-12	Loopback	5 - 12
Fig. 5-13	Pass Thru	5 - 13
Fig. 5-14	System Info	5 - 14
Fig. 6-1	Typical FM/CWLRRRA System Components	6 - 2
Fig. 6-2	Simplified FM/CW Radio Altimeter	6 - 3
Fig. 6-3	Conventional FM/CW Sweep	6 - 4
Fig. 6-4	Conventional FM/CW Radio Altimeter Block Diagram	6 - 4
Fig. 6-5	CDF FM/CW Radio Altimeter Block Diagram	6 - 5
Fig. 6-6	CDF FM/CW Sweep	6 - 5
Fig. 6-7	Triple LRRRA Antenna Installation (ARINC square patch type).	6 - 6

Fig. 6-8	LRRA Antenna Installation (recessed horn type)	6 - 6
Fig. 6-9	Radio Altimeter Antenna Height at Touchdown	6 - 7
Fig. 6-10	Typical EFIS	6 - 8
Fig. 6-11	Analog Indicator Dial Type	6 - 9
Fig. 6-12	Analog Indicator Moving Tape Type	6 - 9
Fig. 6-13	AN/APN-209 Pulse Radio Altimeter	6 - 10
Fig. 6-14	Pulse Radio Altimeter Block Diagram	6 - 11
Fig. 6-15	Approach Types	6 - 12
Fig. 6-16	Terrain Awareness and Warning System	6 - 13
Fig. 6-17	GPWS Inputs	6 - 13

THIS PAGE INTENTIONALLY LEFT BLANK.

List of Tables

TITLE	PAGE
Table 2-1 Function Window Icons	2 - 10
Table 2-2 Numeric Keypad Icons	2 - 11
Table A-1 Ethernet Pin-Out Diagram	A - 1
Table A-2 USB Host 1 Pin-Out Diagram	A - 1
Table A-3 USB Host 2 Pin-Out Diagram	A - 2
Table A-4 USB OTG Pin-Out Diagram	A - 2
Table A-5 DC Power Connector Pin-Out Diagram	A - 2

THIS PAGE INTENTIONALLY LEFT BLANK.

Chapter 1 - Description

1.1 INTRODUCTION ALT-8000



Fig. 1-1 VIAVI ALT-8000

1.1.1 Scope

Type of Manual: Operation Manual

Equipment Name and Model Number: ALT-8000 Radio Altimeter Flight-line Test Set.

Equipment Uses: Testing installed FM/CW, CDF FM/CW and Pulse Radio Altimeters.

1.1.2 Nomenclature Cross-Reference List

Common Name: ALT-8000

Official Nomenclature: Radio Altimeter Flight-line Test Set.

1.2 EQUIPMENT CAPABILITIES AND FEATURES

ALT-8000

The ALT-8000 is a single channel tester, designed for testing FM/CW and Pulse Radio Altimeters in the flight-line environment. The ALT-8000 quickly connects to the Radio Altimeter installation via two antenna couplers.

RF simulation of radio altitude from -20 ft to 5,500 ft (+/- 1.5 ft or 2%, whichever is greater), is provided and altitude rate may be set to provide a smooth ramping altitude simulation to verify decision heights and altitude trips for auto-land systems and altitude data feed to EGPWS.

The user interface is windows based and provides various pages for control of the test set and display of parametric measurements including TX power, TX Frequency (center), Sweep Rate, TX pulse width and TX PRF (pulse systems).

Ratiometric Test

RF Level may be set manually for specific receiver sensitivity measurement or Auto RF Level mode sets an RF Level based on TX Power - Height Path Loss - Scattering Loss. This ensures that the test environment replicates the actual airborne conditions, verifying T/R loop gain and allowing antenna bonding issues (TX-RX cross leakage) to be identified. An additional RF Level offset figure may be set to ensure an altitude sweep passes with a predetermined gain margin.

Transit Case

The ALT-8000 is shipped in a rugged transit case which provides storage for the accessories; AC-DC Power Supply/Charger, External Battery Charger, Antenna Couplers, Coupler Poles, RF Coax Cables, Power Cords, Operation Manual CD and Getting Started Manual.

1.2.1 Capabilities

The ALT-8000 provides users with the following standard capabilities:

- Test FMCW Radio Altimeters, including CDF Types
- Test Pulse Radio Altimeters (non pulse compression types)
- Direct connect to UUT T/R or to installed system via Antenna Couplers

1.2.2 Features

- Ratio-metric RF loop test allows TX, RX, Antenna or Feeder faults (to be identified).
- Programmable multi-leg Climb/Descend profiles
- Large touch screen 12 in display, with simple user interface
- Remote Control Interface LAN
- Lightweight and compact, <10 lbs. (4.5 kg)
- Battery 4 hours plus duration
- Changeable battery
- Radio Altimeter Test Functional Window

1.2.3 Utilities

- Software Upgrade
- Operational Status
- Setup

Chapter 2 - Test Set Operation

2.1 INTRODUCTION

This chapter refers to local operation of an ALT-8015 configured with factory default settings, unless otherwise specified. New Test Sets are configured to start in the factory default setting. Review Installation and Power Requirements before using the Test Set.

2.2 POWER REQUIREMENTS

2.2.1 Power

The ALT-8015 is powered by a removable Lithium Ion Battery. The battery charging circuit enables the operator to recharge the battery anytime the unit is connected to the AC Adapter. The ALT-8015 can operate continuously utilizing the AC Adapter (Fig. 2-1). The internal battery is equipped to power the ALT-8015 for four continuous hours of use.

AC Power Requirements

The AC Adapter, supplied with the ALT-8015, operates over a voltage range of 100 to 250 VAC at 47 to 63 Hz. The battery charger operates whenever DC power (11 to 32 Vdc) is applied to the Test Set with the supplied AC Adapter or a suitable DC power source.

NOTE: If the supply voltage is <11 V, the unit will switch automatically to internal battery. If the voltage is >32 V, a 5 Amp resettable thermal fuse on the DC input port will open, protecting the test set. Reset fuse by disconnecting and reconnecting the power cord to the unit.

When charging, the battery reaches 100% charge in approximately four hours. The battery could remain in trickle mode for several hours if the battery is completely discharged. The Battery Charging temperature range is 0° to 45° C, controlled by an internal battery charger.



Fig. 2-1 AC Adapter

2.2.2 Battery Recharging Using External Power Supply

Perform the following steps to recharge the battery using an external power supply:

STEP	PROCEDURE
1.	Connect AC Line Cable to AC POWER Connector on the AC Adapter and an appropriate AC power source.
2.	Connect the AC Adapter DC output to the DC POWER Connector on the ALT-8015.
3.	Verify the BATTERY indicator displays blinking green.
4.	Allow four hours for battery charge or until the BATTERY Indicator displays a steady green. Refer to 2.4.1 for additional battery indicators.

2.3 INSTALLATION

2.3.1 Ventilation Requirements

The ALT-8015 is convection cooled by the enclosure case. Avoid standing the Test Set on or close to other equipment that is hot.

2.3.2 Bench Top Installation

The Test Set can be positioned in flat or tilted position by utilizing the built in screen cover/stand when used in a bench top environment.

CAUTION

TO AVOID DAMAGE TO TOUCH SCREEN, DO NOT STACK OTHER EQUIPMENT ON TOP OF THE TEST SET.

2.4 CONTROLS AND CONNECTORS

2.4.1 Front Panel Controls

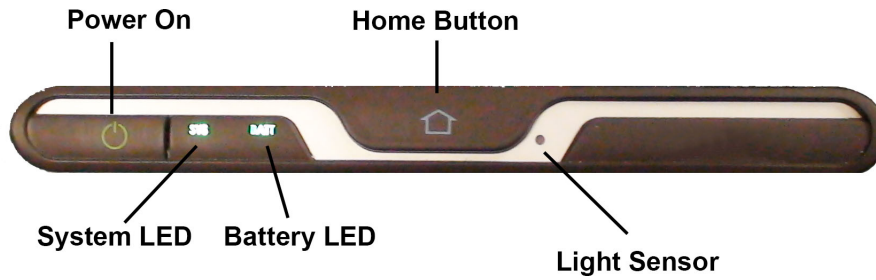

Fig. 2-2 Front Panel Controls

Control	Description
Power ON/OFF	The Power On/Off Button is used to power the Test Set on and off.
System LED	Powered On (green) Indicates the unit is in an operational status.
	Failure (red) Some form of failure has occurred which precludes using the display to indicate the problem (e.g. main processor failure, power supply fault, etc.).
	Boot (flashing blue) Unit is booting and is not yet able to indicate status on the display (during initial OS and application load).
	Off/Standby (orange) Unit is off, but power is supplied to the power supply from the AC power supply.
	Off without External Supply (off) Unit is off, no external power supplied.
Home Button	Pressing and holding the Home Button for 5 sec sets the backlight to maximum brightness.
Magnetic Sensor	Detects if the display cover is open or closed and used to turn off the display as part of power management.

Control	Description
Battery LED	<p>Battery Voltage Low (red) The unit turns off within one minute without charger.</p> <p>Battery Pre-Charge (flashing yellow) Trickle charge during extremely low voltage on the battery.</p> <p>Battery Charging (flashing green) Charge in progress.</p> <p>Battery Fully Charged (green) AC Adapter is holding battery at full charge.</p> <p>Battery Temperature Extreme (blue) Temperature <0° C or >45° C can't charge battery.</p> <p>Battery Error (red) Problem with the battery or charging system.</p> <p>Battery Missing (Off) AC applied without battery in place.</p> <p>Normal Operation (Off) Operating on battery with AC Adapter not connected.</p> <p>Test Set Off (Off) Test Set is turned off with AC Adapter not connected.</p> <p>Battery Suspended Charge (flashing Red) AC applied with battery charging suspended.</p>

2.4.2 Rear Panel Connectors

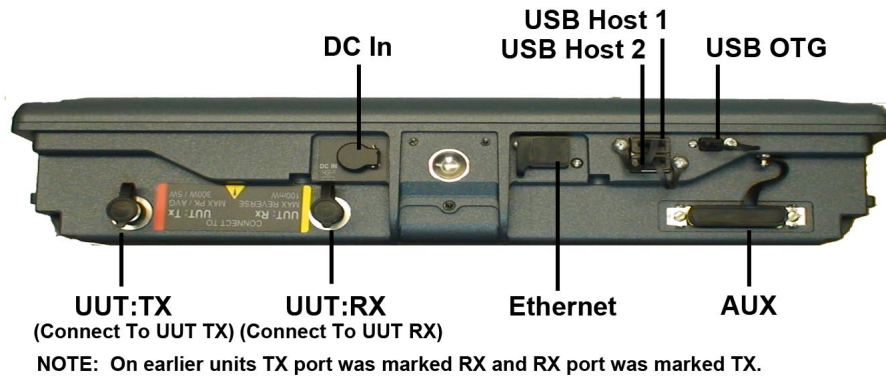

Fig. 2-3 Test Set Rear Panel Controls and Connectors

Connector	Description
USB Host 1	USB standard connection that allows connection of USB devices (e.g. a USB memory stick). Recommended USB memory device is VIAVI PN 67327.
USB Host 2	USB standard connection that allows connection of USB devices (e.g. a USB memory stick). Recommended USB memory device is VIAVI PN 67327.
USB OTG	Currently not in use.
UUT:TX 300 W PK 5 W AVG	RF input for direct connection or antenna coupler. Connects to the TX port of the radio altimeter under test.
UUT:RX 100 mW MAX REVERSE	RF output for direct connection or antenna coupler. Connects to the RX port of the radio altimeter under test.
Ethernet	Standard Base T RJ45 connection. This connection can be used for software upgrades and for remote operation.
DC IN	11 to 32 Vdc external power and battery charge.
Aux	Currently not in use.

2.5 OPERATING PROCEDURES

2.5.1 Power ON Test Set

After completing Initial Installation, perform the following steps to Turn On the Test Set:

STEP	PROCEDURE
1.	Press On/Off Button on Front Panel for a minimum of 1 second to power on Test Set. The Power Up screen is displayed when the unit is first powered on. The Power Up window displays a load progress bar at the bottom of the screen.

2.5.2 Power OFF Test Set

Perform the following steps to power off the Test Set:

STEP	PROCEDURE
1.	Press On/Off Button on Front Panel for a minimum of 0.25 seconds. A prompt is displayed, asking if the user would like to power down the unit.

2.6 USER INTERFACE COMPONENTS

The Test Set User Interface (UI) is a touch screen control panel that provides a flexible working environment for users. The UI utilizes maximized Function Windows i.e. one function window occupies the whole screen area. The UI is navigated locally using the Front Panel Touch Screen.

2.6.1 Launch Bar

The Launch Bar is a vertical scrolling menu located at the left side of the Test Set User Interface. The Launch Bar provides access to the Function keys (Fig. 2-4). The menu must be opened to access the Function keys. The Launch Bar is opened and closed by touching the vertical gray bar along the right side the menu.

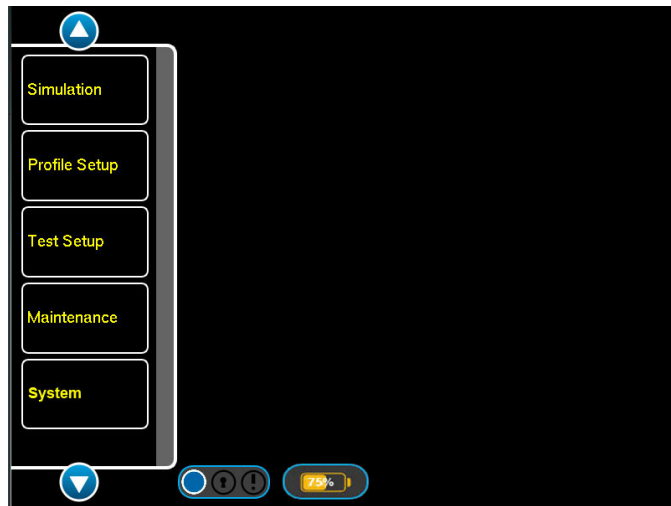

Fig. 2-4 Launch Bar - Open/Close Tab

When opened, the Launch Bar appears in front of any function windows currently occupying that area of the display (Fig. 2-5). The Launch Bar can be closed to view the entire Function Window.

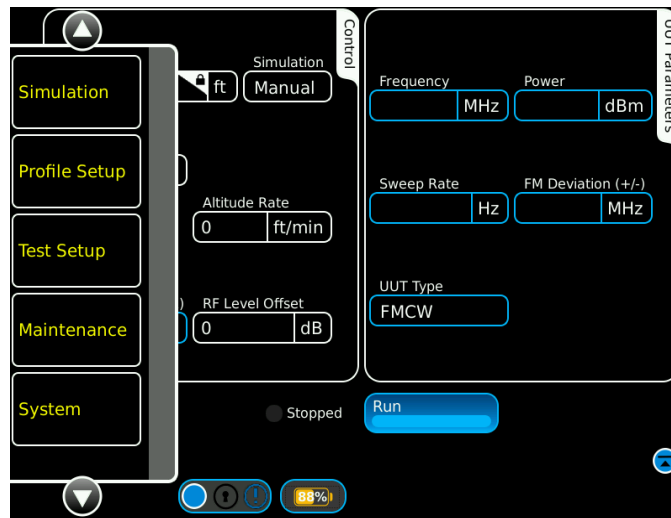

Fig. 2-5 Launch Bar Appears In Front of Function Window

2.6.2 Function Keys

The Launch Bar consists of keys that identify functions installed on the Test Set.

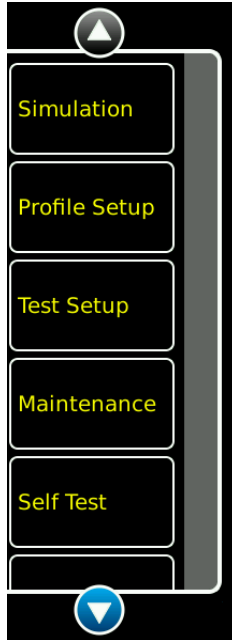

Fig. 2-6 Launch Bar Function Keys

2.6.3 Simulation Function Windows

Simulation Function Windows provide visual access to the Test Set's control parameters and displayed data.

Function	How to
<p>Opening/Closing Function Windows</p>	<p>Simulation Function Windows are opened by selecting the Function Icon from the Launch Bar. Function Windows are closed by selecting the blue circle icon at the bottom right of the window, or by selecting a new function window.</p> <p>Only one function window may be open at a time.</p>

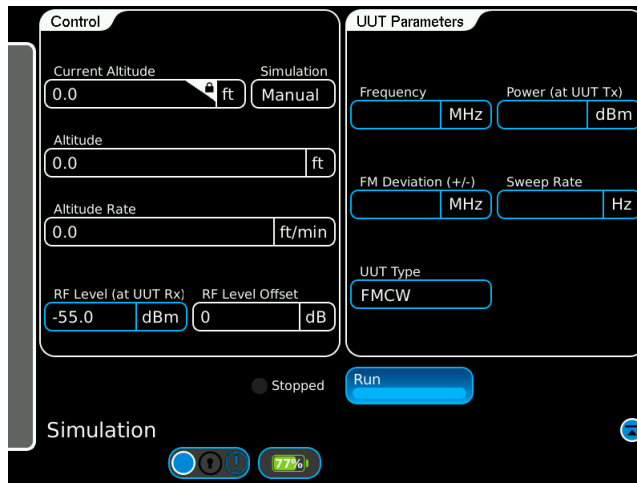

Fig. 2-7 Simulation Function Window

2.6.4 Function Window Icons

Function Windows use the following icons to indicate various functions or states:

ICON	DESCRIPTION
	Closes the Function Window while leaving the function in the Active State.
	Maximizes Function Window or opens Status Bar.
	Minimizes Function Window or closes Status Bar.
	Displays Detecting and a yellow circle when detecting the type of radio altimeter under test.
	Displays Running and a green circle when the simulation is running.
	Displays Stopped and a gray circle when the simulation is stopped.
	Displays the remaining battery capacity as a percent (%).

Table 2-1 Function Window Icons

2.7 DEFINING PARAMETERS

2.7.1 Entering Numeric Values

Numeric values are used to define a variety of test parameters such as frequency and level. When a numeric data field is selected for editing, a group of data entry pop-up windows is launched which provides three methods for defining the value; Numeric Keypad, Data Slew Bar or Rotary Knob.

2.7.2 Numeric Keypad and Slider Bar

The Numeric Keypad allows the user to enter a specific numeric value. A value is entered by pressing the numbers on the keypad. The value is enabled by pressing the unit of measurement on the Numeric Keypad window.

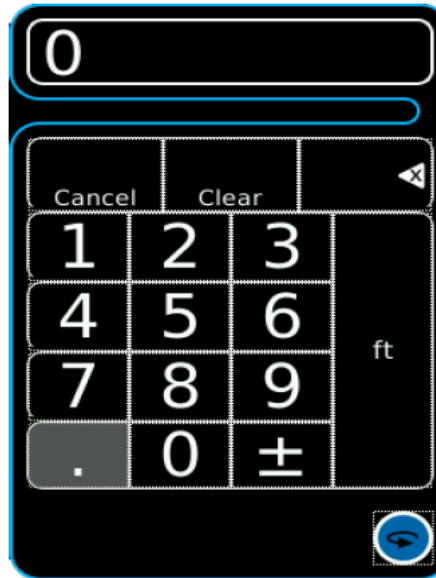

Fig. 2-8 Numeric Keypad





Icon	Description
	Pressing Cancel voids any un-entered changes and closes the group of data entry pop-up windows.
	Pressing Clear ignores the current entry, allowing a new value to be entered.
	Pressing Backspace deletes the last digit in the numeric value.
	Pressing Next Value Selection replaces the Numeric Keypad with the Rotary Knob. Press the Next Value Selection again and the Rotary Knob is replaced with the Slew Data Bar. Press again and the Numeric Keypad appears.

Table 2-2 Numeric Keypad Icons

2.7.3 Data Slew Bar

The Data Slew Bar incrementally selects specific data values by sliding the bar. Selecting x10 increases the step increment by a factor of 10. Selecting /10 decreases the step increment by a factor of 10. Selecting Enter closes the Data Slew Bar.



Fig. 2-9 Data Slew Bar

2.7.4 Rotary Knob

The Rotary Knob is used to slew values up or down. Selecting x10 increases the step increment by a factor of 10. Selecting /10 decreases the step increment by a factor of 10. Selecting Enter closes the Rotary Knob.

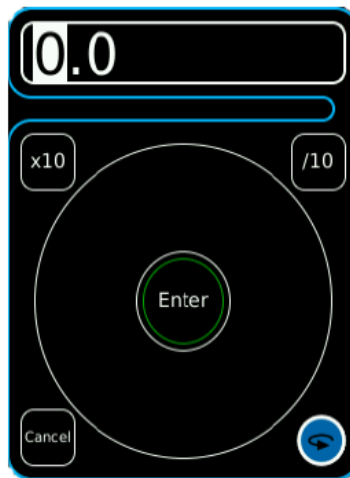

Fig. 2-10 Rotary Knob

2.7.5 Drop-down Menus

Drop-down Menus are used to list pre-defined variables. Selecting a Drop-down Menu opens the list of variables available for that field. The variable currently selected is displayed on the menu as a white label on a blue background (Fig. 2-11). Drop-down Menus can be dragged up and down on the display in order to view long lists.

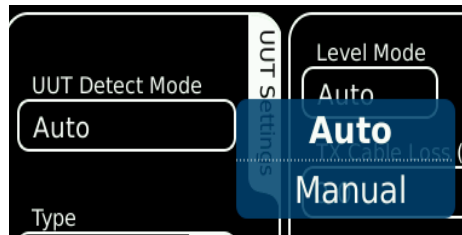

Fig. 2-11 Drop-down Menu

2.7.6 Selectable Units

Some fields may have selectable units. For those fields identified, select the units field and a drop-down menu is displayed.



Fig. 2-12 Selectable Units

2.7.7 Locked Fields

A small padlock symbol may be displayed against certain fields indicating that the field is locked and may not be edited or accessed (Fig. 2-13). Current Altitude field is locked because it can only be modified when a manual simulation is running, then paused.

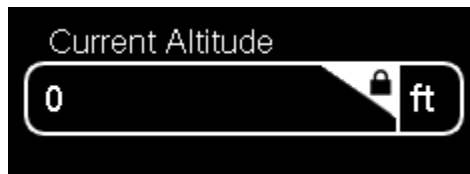

Fig. 2-13 Locked Field

THIS PAGE INTENTIONALLY LEFT BLANK.

Chapter 3 - Test Set Functions

3.1 INTRODUCTION

This chapter provides an operational description of standard simulator functions.

3.2 TEST SET FUNCTIONS

3.2.1 Simulation Function Window

The Simulation Function Window is the main test screen and is used to control the altitude rate, simulation type, start /stop altitudes, altitude offset and RF return level. UUT Type and UUT:TX Frequency and Power are displayed. Sweep Rate and FM Deviation are displayed for FM/CW types, with PRF and Pulse width displayed for pulse types.

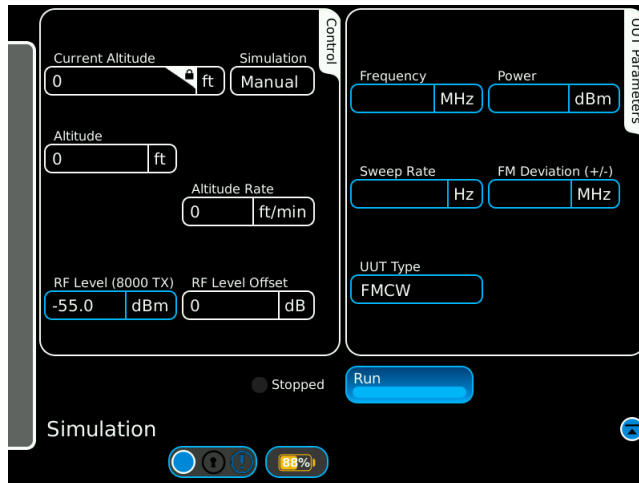

Fig. 3-1 Simulation Function Window (Simulation: Manual)

3.2.1.A Auto RF Level Test

FM/CW Radio Altimeter specifications generally do not provide receiver sensitivity figures. TX power can vary considerably between different designs. Sufficient loop gain exists in the system to provide altitude tracking over the operational range of the radio altimeter, typically -20 to between 2,500 and 5,500 ft.

Many radio altimeter designs adjust receiver sensitivity in proportion to height i.e. decreasing sensitivity at the lower altitudes to avoid noise and multipath tracking problems. Although the ALT-8000 can measure receiver sensitivity and TX power, this is useful only where the installed system specification is known, including the antenna feeder losses.

The ALT-8000 Auto RF Level mode adopts a loop gain or Ratio-Metric approach to test overall system functionality by setting a RF return level that is proportional to the receiver TX power, taking into account the path loss and scattering loss that would normally occur if the 4.3 GHz signal were reflecting off the ground.

By introducing an offset to this RF return level (reducing the return signal by a user set figure in dBs), an altitude sweep that tracks and does not flag throughout its complete range is a positive end to end test and confirmation that the Radio Altimeter will function in the real world environment, with a safety margin included.

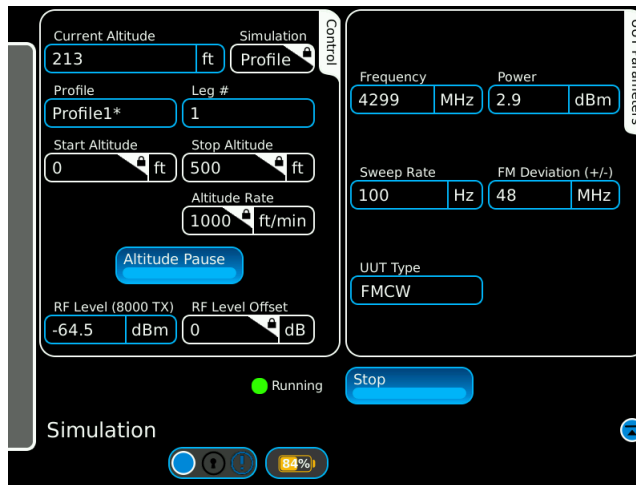

Fig. 3-2 Simulation Function Window (Simulation: Profile)

Control Component	Description
Sweep Rate	Displays TX FM Sweep Rate. Resolution 1 Hz.
FM Deviation	Displays TX FM deviation in MHz. Resolution 1 MHz.
Power	Displays measured TX Power in watts, milliwatts or dBm. Resolution 1 mW.
Frequency	Displays measured TX Center Frequency in MHz. Resolution 1 MHz.
Current Altitude	Displays the current altitude simulated by the test set for manual or profile operation.
UUT Type	Displays the current UUT type as determined in Setup Function Window UUT Type field or through Auto Detect. Type is Pulse, FMCW or CDF FMCW.
Profile	Displays current profile name being executed. NOTE: Not displayed when Simulation Field is set to manual.
Leg	Displays the current leg # of the current selected profile NOTE: Not displayed when Simulation Field is set to manual.
Simulation	Drop down menu provides control of simulation type. Selections are Manual and Profile. MANUAL Allows user to enter Start Altitude, Stop Altitude and Altitude Rate and execute a linear ramp up or down. PROFILE runs pre-programmed altitude profiles stored in the profile page.

Control Component	Description
Start Altitude	Numeric pad. In Simulation:MANUAL mode, start altitude may be entered in feet by the user. In Simulation:PROFILE mode, start altitude becomes an advisory field for the current profile leg running. Resolution 1 ft, Range -20 ft to 5,500 ft.
Stop Altitude	Numeric pad. In Simulation:MANUAL mode, stop altitude may be entered in feet by the user. In Simulation:PROFILE mode, stop altitude becomes an advisory field for the current profile leg running. Resolution 1 ft, Range -20 ft to 5,500 ft.
Altitude Rate	Numeric pad. In Simulation:MANUAL mode allows altitude rate to be set in ft/min or ft/s. Range 1 to 120,000 ft/min or 1 to 2,000 ft/s. In Simulation:PROFILE mode becomes an advisory field for current profile leg running. NOTE: Altitude rate may be paused (Altitude Pause Key). In Manual Mode, altitude rate may be reversed (Reverse Key). In Manual Mode, manual slew keys are displayed and allow the user to manually slew the altitude up or down for testing trips, sticking indicator pointers, etc.
RF Level	Numeric pad. If Setup functional window Level Mode field is set to AUTO, then this field is advisory. RF Level is set proportional to incoming power minus path loss of simulated altitude, minus scattering loss (this has hard limits for high power pulse operation). If Set functional window Level Mode field is set to MANUAL, then user may set RF level within operational range of test set with a resolution 1dBm.
RF Level Offset	Numeric pad. This field allows the user to enter an RF offset level in dB. This offset gets added in the Auto Level mode, which establishes a specific loop gain margin for altitude linear ramp tests. NOTE: Radio Altimeter receivers typically change their receiver bandwidth and gain in proportion to height.

Altitude and altitude rate can be entered in units of feet or meters. The test set works exclusively in feet so any value entered in meters will be converted to feet and then converted back to meters. As a result, values entered in meters may change after entry.

For instance, upon entering an altitude of 200m, it will be displayed as 199.9m which corresponds to 656 ft.

3.2.1.B Pulse Radio Altimeters

The following UUT parameters are displayed when testing pulse radio altimeters:

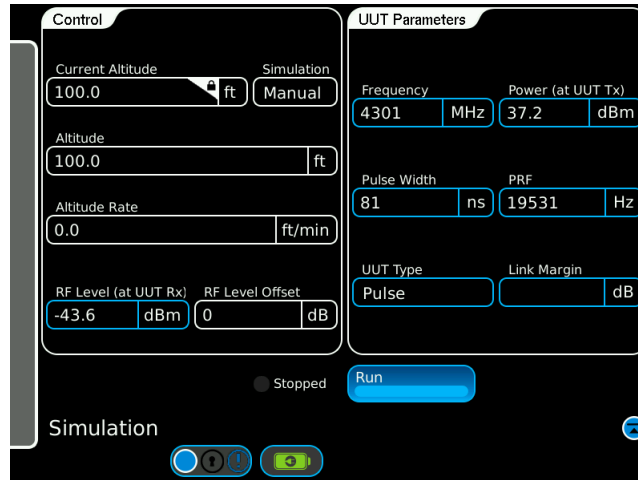

Fig. 3-3 Radio Altimeter Test Function Window Pulse

Display Component	Description
PRF	Displays TX PRF in Hz. Resolution 1 Hz. Value is blank while running a ramp simulation.
Pulse Width	Displays TX pulse width in ns. Value is blank while running a ramp simulation.
Power	Displays measured TX Power in watts, miliwatts or dBm. Resolution 1 mW. Value is blank while running a ramp simulation.
Frequency	Displays measured TX Center Frequency in MHz. Resolution 1 MHz. Value is blank while running a ramp simulation.

3.2.2 Profile Setup Function Window

The Profile Setup function window allows the user to create, save, recall or delete user named profiles. Profiles are used to control dynamic altitude simulations. Each profile is comprised of individual legs which are executed in numeric sequence. Start, stop altitudes and rates are definable for each leg. A profile can then be executed to simulate a complete landing approach including flare out, take-off and departure. Each Profile may consist of up to 20 legs.

NOTE: When simulating altitude ramps or profiles legs with altitude rates on pulse altimeters the UUT parameters will be blanked. Anytime the simulated altitude rate returns to zero the UUT parameters will be displayed.

The profile legs are plotted on a chart showing altitude versus time. When the selected profile is running, an aircraft symbol indicates the progress of the simulation on the chart.

The measurement unit for the profile can be changed between feet and meters by clicking on the Profile Display Units field (Test Setup, Display Tab) and using the pop-up menu to change the unit of measurement.

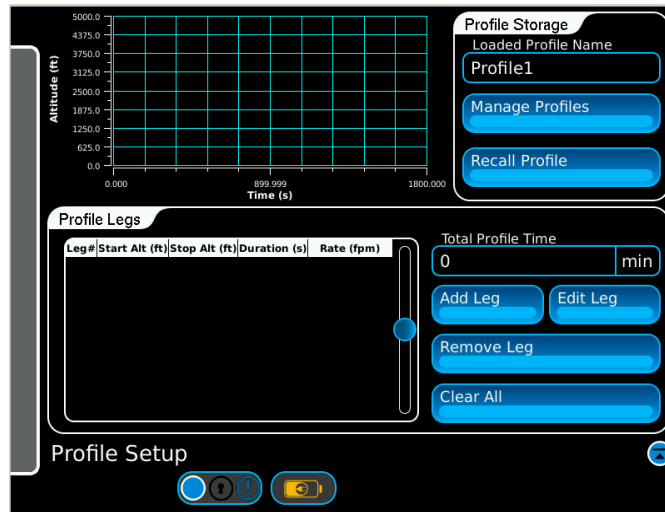

Fig. 3-4 Profile Setup Function Window

Control Component	Description
Add	Displays Add Leg # window.
Edit	Displays Edit Leg # window.
Remove Leg	Deletes the selected leg in the current profile table.
Clear All	Deletes all legs in the current profile table.
Manage Profiles	Displays the Manage Profiles Function Window.
Recall Profile	Displays the Load Profile Function Window.

Functions

Display Component	Description
Loaded Profile Name	Displays current profile name.
Total Profile Time	Displays the total duration of the current profile in minutes.
Leg #	Displays leg number.
Start Alt	Displays Start Altitude. Range -20 to 5,500 ft. Resolution 1 ft.
Stop Alt	Displays Stop Alt Range -20 to 5,500 ft. Resolution 1 ft.
Duration (s)	Displays duration of leg in seconds (auto calculated if Altitude Rate is set).
Rate (ft/min)	Displays Altitude Rate in ft/min. Range 1 to 120,000 ft/min.

3.2.2.A Add Leg # Window

The Add Leg # Window is used to enter data for new legs in a profile. To create a new leg, select the “Add New Leg” line in the profile table to open the Add Leg # window.

3.2.2.B Edit Leg # Window

To edit an existing leg, select the desired line in the profile table and select the Edit Leg key to display the Edit Leg # window (Fig. 3-5).

NOTE: When adding a new leg, the Start Altitude field will automatically display an entry equal to the Stop Altitude defined in the previous leg. This may be overwritten to create a step altitude if required. The Altitude Rate may be set for each leg, which will result in an auto calculation for Leg Duration being displayed.

NOTE: If level flight is required for a specific leg, set the Start and Stop altitudes to be equal. The Altitude Rate field will be replaced by the Leg Duration field. Enter the required duration of level flight in the Leg Duration field in seconds.

Control Component	Description
Start Altitude	Numeric pad. Enter Start Altitude. Range -20 to 5,500 ft. Resolution 1 ft.
Stop Altitude	Numeric pad. Enter Stop Altitude. Range -20 to 5,500 ft. Resolution 1 ft.
Leg Duration	Numeric pad. Enter duration of leg in seconds or minutes. NOTE: Auto calculated if Altitude Rate is set.
Altitude Rate ft/min	Numeric pad. Enter Altitude Rate in ft/min. NOTE: Replaced by Leg Duration, if level flight is selected i.e. Start Altitude = Stop Altitude.
Enter	Select Enter to confirm leg and close window.

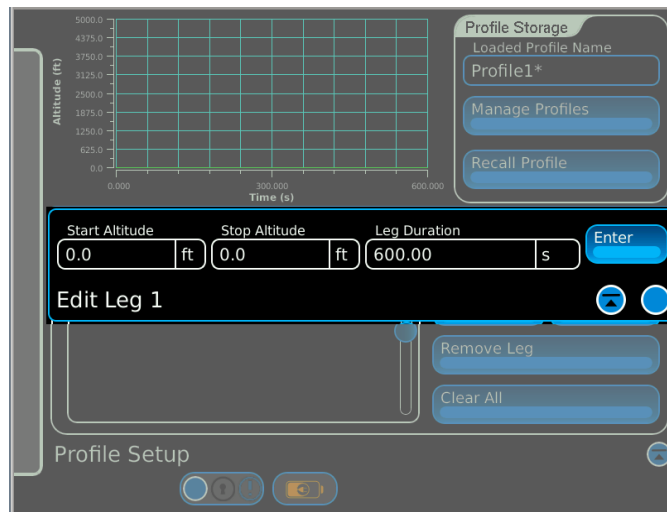

Fig. 3-5 Edit Leg # Window

3.2.2.C Profile Management

The Profile Management control provides named storage and recall for profiles. Each profile consists of up to 20 legs (Fig. 3-6). Profiles are stored in sequence of entry.

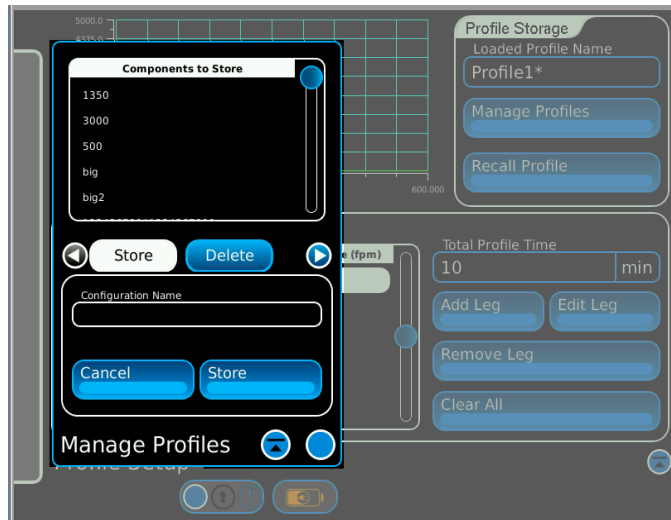

Fig. 3-6 Manage Profiles Window (Store Profile)

A 20 character store filename may be entered. The on-screen keyboard will be removed when the Enter or Cancel keys are hit. Selecting Store key stores the named profile.

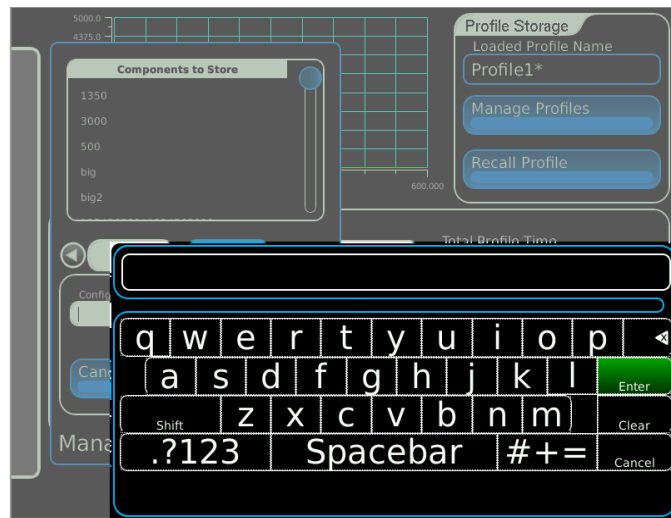

Fig. 3-7 Manage Profiles Window (Store Name Entry)

Press Delete tab to access delete functions in Manage Profiles window.

Select the stored file to be deleted from the Profile Name list.

Press the Delete Store key to delete stored file.

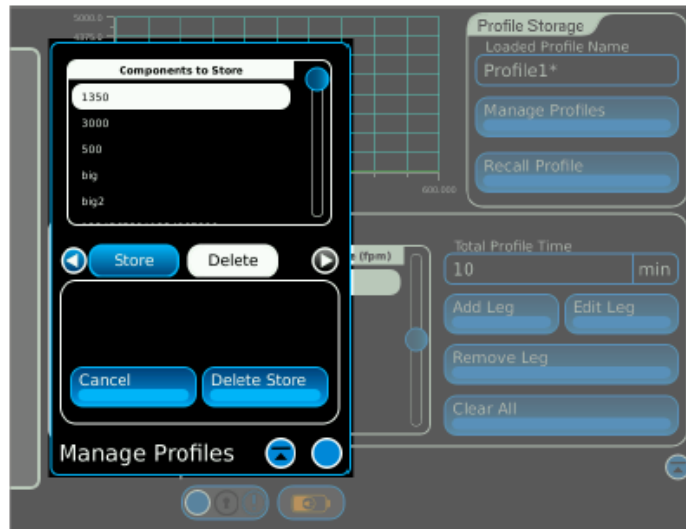

Fig. 3-8 Manage Profiles Window (Delete Profile)

Control Component	Description
Delete Store	Deletes selected store.
Store	Stores named profile.
Cancel	Cancels storage operation and closes window.

Display Component	Description
Configuration Name	Displays selected profile name.
Profile Name	Displays list of stored profiles.

3.2.2.D Load Profile Function Window

Selecting the Recall Profile Key displays the Load Profile Function Window. The Load Profile Function Window is used to select and load a stored profile into test set memory for execution (Fig. 3-9).

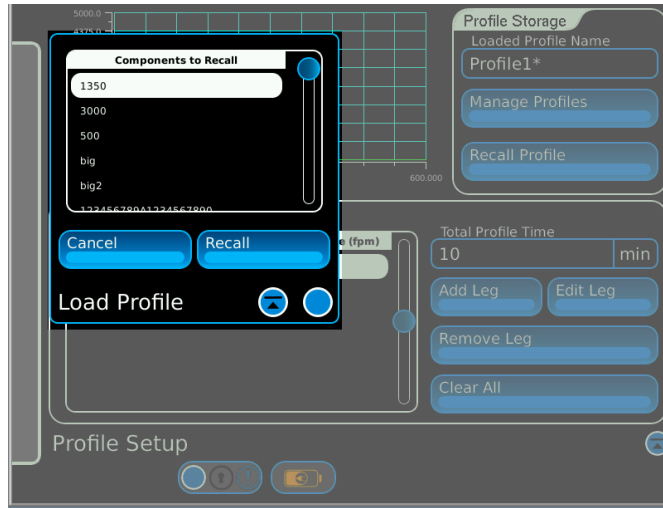

Fig. 3-9 Load Profile Window

Control Component	Description
Recall	Loads selected profile in memory for execution.
Cancel	Deletes selected profile.

Display Component	Description
Profile Name	Displays profile name.

3.3 TEST SETUP

3.3.1 Test Setup Function Window

The Test Setup Function Window is used to configure the Test Set operational parameters. Fig. 3-10 shows the General Tab Screen. Fig. 3-11 shows the Loss Tab Screen. Fig. 3-12 show the Storage Tab Screen. Fig. 3-18 shows the Display Tab Screen.

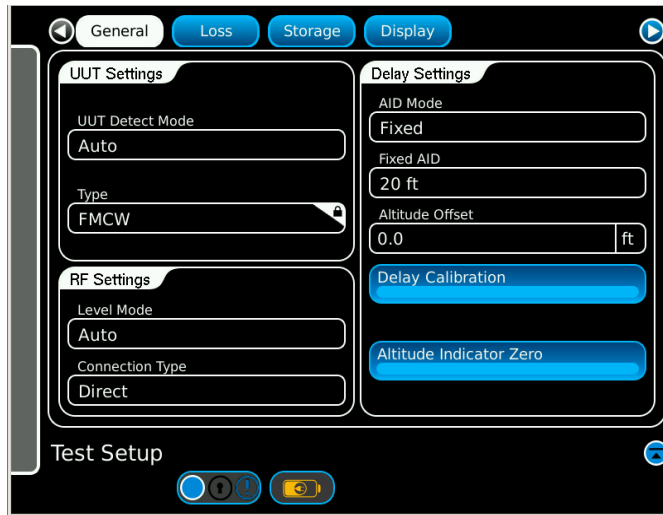

Fig. 3-10 General Tab Screen

General Tab Control Component	Description
Level Mode	Auto - RF Level is set proportional to incoming power minus path loss of simulated altitude, minus scattering loss. Manual - User may set RF level within operational range of test set.
Connection Type	Coupler - For connection via antenna couplers. Feeder - For connection to end of antenna feeder cables. Direct - For connection directly to UUT. NOTE: Fixed and Variable AID are only displayed when selection is Direct.
UUT Detect Mode	Auto - For automatic detection of Radio Altimeter Type. Manual - For user selection of Type field.
Type	FMCW - For conventional FM/CW altimeter. CDF FM/CW - For selection of Constant Difference Frequency type altimeter. Pulse - For Pulse altimeter. Gated FM/CW - For gated FM/CW altimeters, e.g., GRA-55
AID Mode	Fixed - Fixed AID field is displayed. Variable - Variable AID field is displayed.
Fixed AID	Provides selection of standard AID (Aircraft Installation Delay). Selections: 0, 20, 40, 57 or 80 ft (ARINC standard AIDs) NOTE: Only displayed with Connection type Direct selected.

General Tab Control Component	Description
Variable AID	Provides user entry of AID. Range 0 to 99 ft. NOTE: This field is for entering non ARINC AIDs. NOTE: Only displayed with Connection type Direct selected.
Delay Calibration	Displays a Delay Calibration screen with instructions. Connect ends of test cables together using supplied TNC adapter and press this key to automatically calibrate the test set and cable delay. Range: 100 ft length and 10 dB loss per cable. Allows cable with different velocity factors to be used.
Altitude Indicator Zero	Displays an Altitude Indicator Zero screen. Used to zero aircraft altitude indicator (FM/CW CDF only).
Altitude Offset	Range 0 to 100 ft, in 0.5 ft increments. Although the AID will be known for most FM/CW type installations, the AID is the RF feeder cable delay plus the antenna to ground path length at touch down, prior to de-rotation of the aircraft. In most cases the antenna height above ground in ft will not be known by the user for each aircraft type, so this function is used to set aircraft altitude indicator to 0 ft. NOTE: If aircraft antenna height from ground at touch down is known, it may be entered in the altitude offset field. NOTE: Path loss compensation is applied proportional to altitude offset in ft when Connection Type = Coupler or Feeder

3.3.1.A Loss Tab

Loss Tab allows changes to Cable, Coupler Loss and External Attenuation settings. Settings are changed by clicking on the setting entry field.

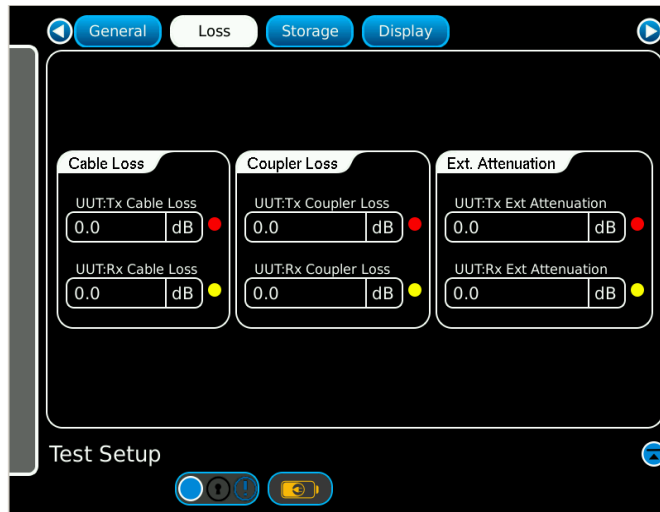

Fig. 3-11 Loss Tab Screen

Loss Tab Control Component	Description
UUT:TX Cable Loss	Specifies UUT:TX Cable Loss in dB. Range 0 to 9.9 dB.
UUT:RX Cable Loss	Specifies UUT:RX Cable Loss in dB. Range 0 to 9.9 dB.
UUT:TX Coupler Loss	Specifies UUT:TX Antenna Coupler Loss in dB. Range 0 to 19.9 dB.
UUT:RX Coupler Loss	Specifies UUT:RX Antenna Coupler Loss in dB. Range 0 to 19.9 dB.
UUT:TX Ext Attenuation	Specifies UUT:TX External Attenuation in dB. Range 0 to 20.0 dB.
UUT:RX Ext Attenuation	Specifies UUT:RX External Attenuation in dB. Range 0 to 50.0 dB.

3.3.1.B Storage Tab

Storage Tab provides named settings file store and recall for all test set settings. Only one settings file may be loaded in memory for use. The number of named settings files that may be stored is only limited by available memory. An alert message will indicate when the memory limit is reached.

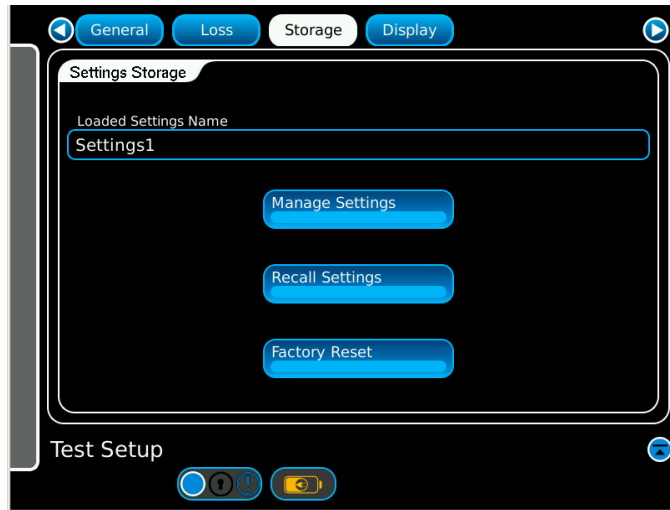

Fig. 3-12 Storage Tab Window

Storage Tab Control Component	Description
Loaded Settings Name	Displays name of last settings loaded into test set operational memory.
Manage Settings	Displays Manage Settings Function Window.
Recall Settings	Displays Load Settings Function Window.
Factory Reset	Resets all settings to factory default.

Selecting the Manage Settings key displays the Manage Settings Function Window (Fig. 3-13). Settings files are stored in sequence of entry.



Fig. 3-13 Manage Settings Window (Store Settings)

Click on the Configuration Name field to access the on-screen keyboard. A twenty character store name may be entered. Selecting Store key stores the named settings.

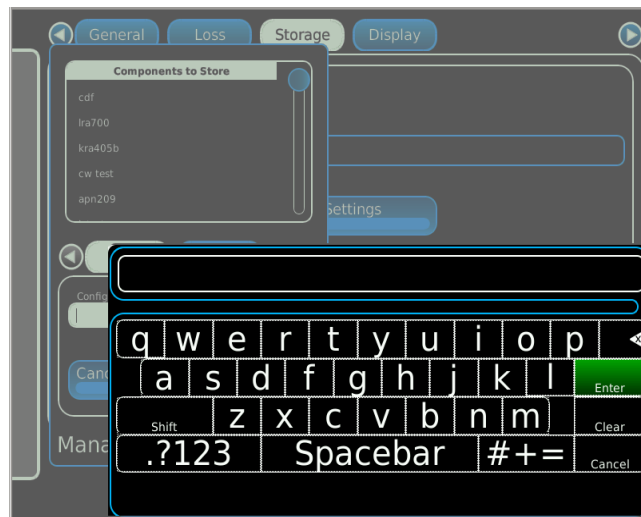

Fig. 3-14 Manage Settings Window (Store Name Entry)

Press Delete tab to access delete functions in Manage Settings Window.
Select the stored file to be deleted from the Profile Name list.
Press the Delete Store key to delete stored file.

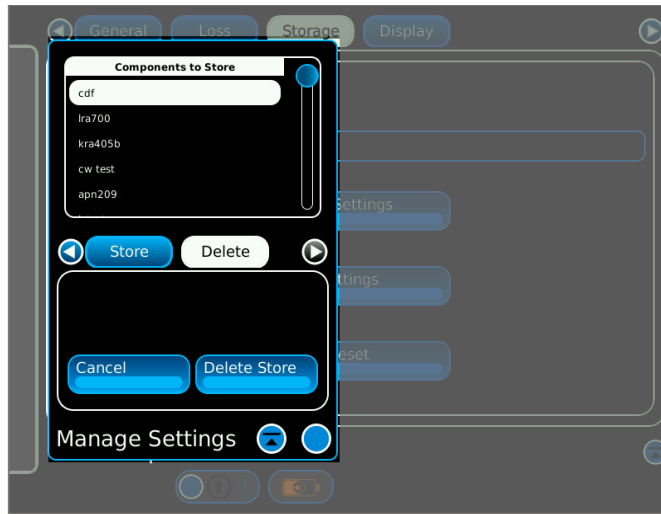

Fig. 3-15 Manage Settings Window (Delete Settings)

Selecting the Recall Settings key displays the stored settings.
Settings files are stored in sequence of entry. Select a setting and press Recall.

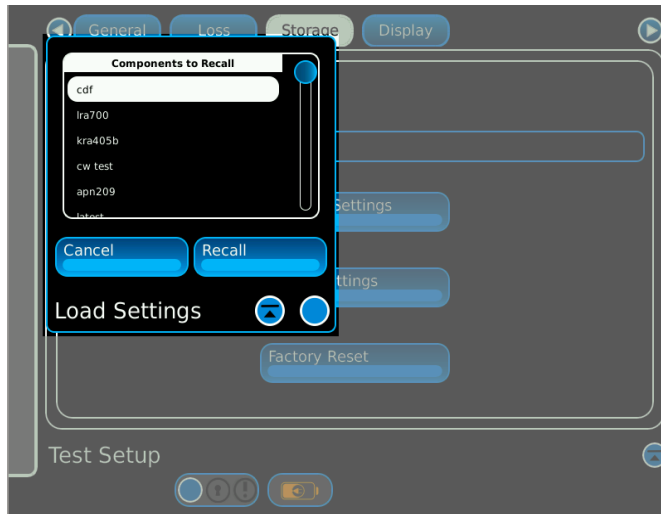

Fig. 3-16 Load Settings Window (Recall Settings)

Selecting the Factory Reset key will reset the test settings to default.

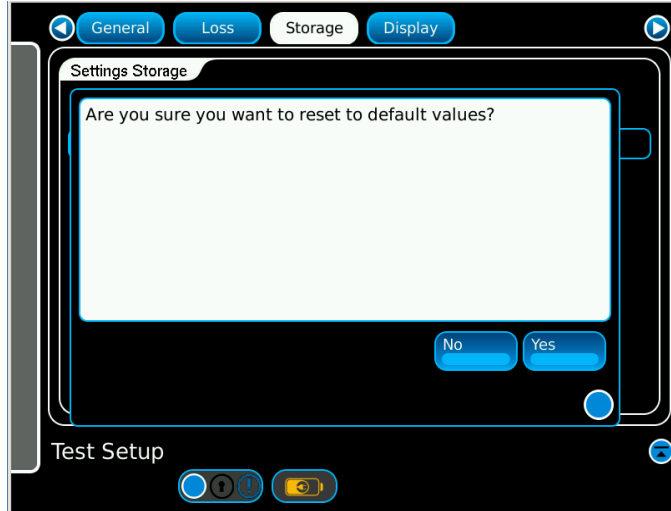

Fig. 3-17 Storage Tab Window (Factory Reset)

3.3.1.C Display Tab

Display Tab allows changes to the frequency display mode, profile measurement units and the power levels. These settings are not affected when loading a settings store. These settings are retained even when the test set is powered off. These settings are reset on a factory reset.

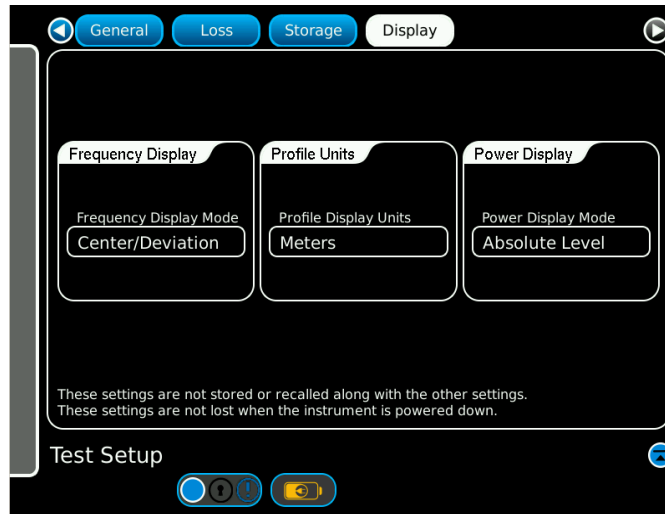

Fig. 3-18 Display Tab Window

Display Tab Control Component	Description
Frequency Display	Click in the Frequency Display Mode field to change the display modes on the Simulation Screen.
Profile Units	Click in the Profile Units field to change the unit of measurements on the plot on the Profile Setup Screen.
Power Display	Click in the Power Display Mode field to change between an absolute power level or a loop loss on the Simulation Screen.

3.3.2 Self Test Function Window

The Self Test Window confirms the Test Set is operating correctly.

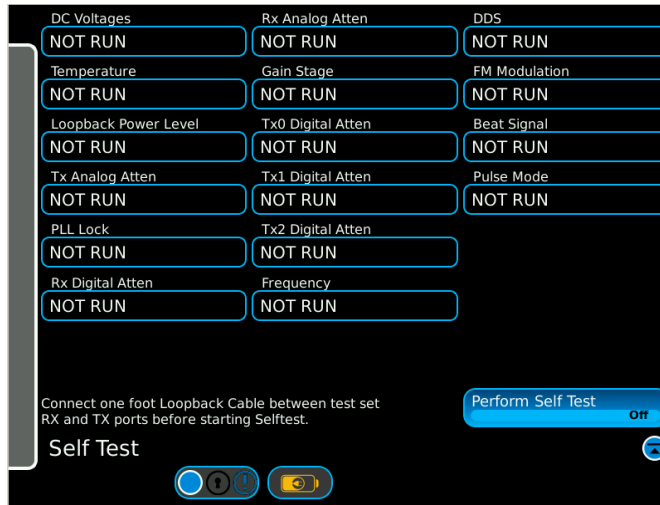

Fig. 3-19 Self Test Screen

The one foot loopback cable must be attached between the test set RF ports before running the Self Test.

The Test Setup Function Window displays the Self Test data when the test is running.



Fig. 3-20 Self Test Running

The Test Setup Function Window displays the Self Test results when the test has been completed.

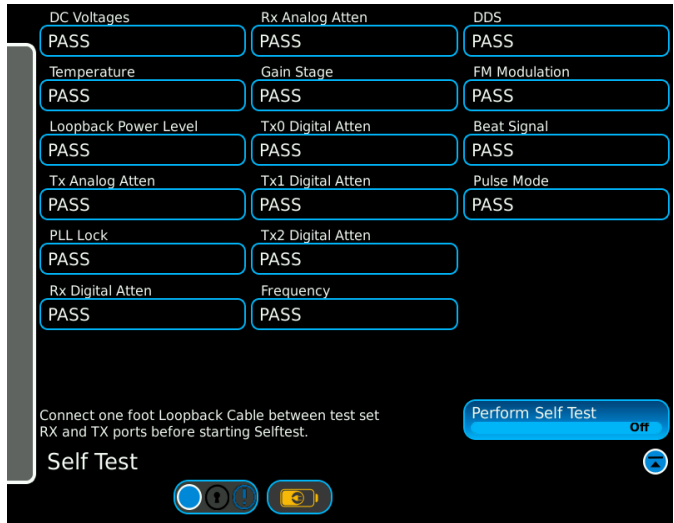

Fig. 3-21 Self Test Passed

3.3.3 Status Bar Alert Messages

The Status Bar is displayed at the bottom of each of the main function windows. The status bar displays and logs any system debug, status, warning, or error messages. These messages are generated by modules within the ALT-8000.

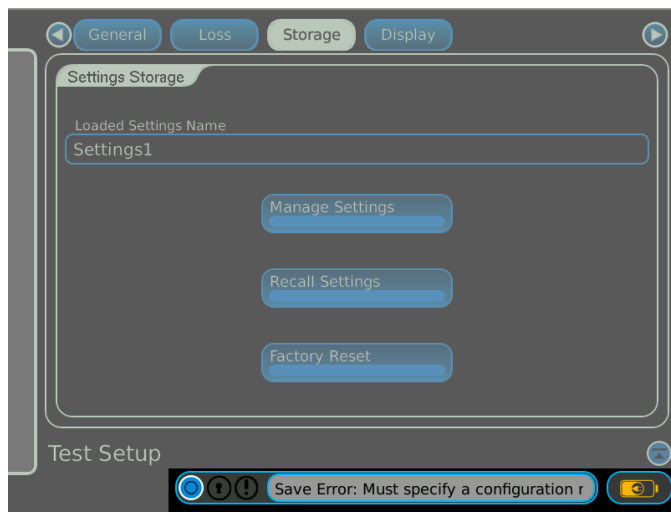

Fig. 3-22 Status Bar

3.3.3.A Alert Messages

The gray status bar may be pressed to display the Alert Message Log. The last 1,000 messages are displayed (Fig. 3-23).

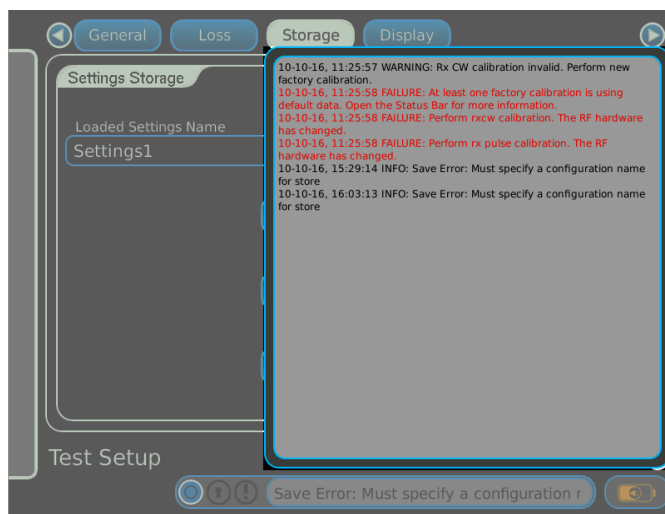

Fig. 3-23 Alert Message Log

Alert Messages displayed at power-up:

- TCXO calibration invalid. Perform new factory calibration.
- RX CW calibration invalid. Perform new factory calibration.
- RX pulse calibration invalid. Perform new factory calibration.
- Transmit calibration invalid. Perform new factory calibration.
- Analog variable attenuator calibration invalid. Perform new factory calibration.
- User delay calibration invalid. Perform calibration before running tests.
- At least one factory calibration is using default data. Open the Status Bar for more information.

Alert messages displayed during factory calibrations:

- Loopback calibration failure: Power too low - Is the loop - back cable connected?

Alert Messages displayed on completion of user calibration:

- Delay calibration failure: Failed to determine cable delay for pulse mode.
- Delay calibration failure: Failed to determine cable delay for FM CW mode.
- Delay calibration failure: No signal detected at RF In.
- Delay calibration failure: Too much loss. Remove any external attenuators. If there are no external attenuators attached, then use lower loss cables.
- Delay calibration completed successfully.

Alert Messages displayed when a test is started:

- UUT center frequency out of range. Test stopping.
- UUT transmit frequency too high. UUT measurements continue but no RF is output.
- Unable to detect reasonable UUT signal. Testing stopped.
- Signal at RF In appears to be CW.
- Power too low at RF In. Testing stopped.
- Pulse Power too low at RF In. Testing stopped.
- Invalid Pulse UUT Detected. Testing stopped.
- Power level varying, cannot determine level. Testing stopped.
- A level flight path has been entered with an Altitude Rate. Change the Altitude Rate to 0 for level flight. Testing stopped.
- RF firmware requires an update to support Gated FMCW radio altimeters. Testing stopped.

If UUT Detect Mode is manual:

- User set UUT type (FMCW) does not match detected UUT type (CDF FMCW).
- User set UUT type (CDF FMCW) does not match detected UUT type (FMCW).
- User set UUT type (FMCW/CDF) does not match detected UUT type (PULSE).
- Pulses not detected. Check that the pulse radio is connected correctly.

Alert Messages displayed during store/recall:

- Store Profile window open: please close window and try again.
- Load Profile window open: please close window and try again.
- Store Settings window open: please close window and try again.
- Load Settings window open: please close window and try again.

Chapter 4 - Testing

4.1 INTRODUCTION

This chapter provides details of standard tests for Radio Altimeter receivers.

4.1.1 Antenna Couplers and Installation Kit

The supplied Antenna Couplers provide an easy, system independent means of coupling test signals to the Radio Altimeter. Radio Altimeter antennas are manufactured in several formats. The complete antenna coupler kit includes sectional mounting poles and standard 20 ft length Low Loss RF Coax Cables, with a cable transit case.

Installation kit includes:

- Antenna Coupler (2)
- Gas Loaded Shock (2)
- Extension Poles (8)
- Spring Loaded Shock (2)
- Low Loss RF Coax Cable, 20 ft (2)
- Jumper RF Coax Cable, 1 ft

Antenna Coupler

There are two couplers supplied. One to be labeled TX by the customer using the supplied decal, which is installed over the TX antenna, and another to be labeled RX by the customer using the supplied decal, which is installed over the RX antenna. The coupler is designed so the active element is encased in radar absorbent foam. A 1 in deep RF edge mounted gasket provides an RF non scratching seal to the fuselage (Fig. 4-1).



Fig. 4-1 ALT-8000 Antenna Coupler

Adjustable Gas Loaded Shock Unit

The 10.5 inch to 16 inch Gas Loaded Shock Unit is adjustable and applies a pre-loaded upward pressure to hold the antenna couplers in place and allows for aircraft fuselage movement.



Fig. 4-2 Pole #1

Sectional Extension Poles

Sectional Extension Poles allow height extension up to a maximum of 91 inches (ground to coupler gasket). A 9 inch pole, a 15-24 inch adjustable pole and two 24 inch poles are included.



Fig. 4-3 Extension Pole #2



Fig. 4-4 Extension Pole #3

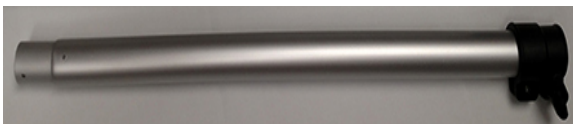

Fig. 4-5 Extension Pole #4

Low Loss RF Coax Cable, 20 ft

The 20 ft Coax Cable connects the Test Set to the UUT or Antenna Coupler, depending on the test mode.



Fig. 4-6 Low Loss RF Coax Cable, 20 ft

Jumper RF Coax Cable, 1 ft

The 1 ft Jumper RF Coax Cable is used during Self Test and factory calibration.



Fig. 4-7 Jumper RF Coax Cable

Attenuator, fixed 20 dB

20dB RF Attenuator is used to increase dynamic range of the test set.



Fig. 4-8 Attenuator, fixed 20 dB

4.1.2 Testing Pulse Type Altimeters with the 20dB Attenuator

Pulse type altimeters with altitude ranges above 1500ft may require the use of a 20dB attenuator on the UUT:RX port to extend the dynamic range of the ALT-8000.

To use the attenuator during testing, perform the following steps:

STEP	PROCEDURE
1.	Install the 20dB attenuator on the UUT:RX port <u>AFTER</u> the delay calibration has been performed.
2.	Navigate to the Test Setup window and select the Loss Tab.
3.	Enter the 20dB of loss in the UUT:RX external attenuation field.
4.	Continue setup and testing as outlined in the subsequent sections.

4.1.3 Direct Connection

Perform the following steps to direct connect to the altimeter:

STEP	PROCEDURE
1.	Place the ALT-8000 within cable length of the aircraft Radio Altimeter.
2.	Connect the Low Loss RF Coax Cables to the ALT-8000 UUT:TX/UUT:RX TNC connectors.
3.	Perform Setup procedure (4.1.6).
4.	Remove the Radio Altimeter TX and RX cables from the altimeter.
5.	Refer to Fig. 4-9. Connect the UUT:TX RF coax cable to the altimeter.
6.	If there is doubt about which Radio Altimeter Port is the TX Port, select Launch Bar tab to display launch bar. Select Simulation function key to display Simulation Window. Press Run to start test and confirm that a TX Power reading is displayed.

NOTE: The ALT-8000 will not function correctly if cable connections are reversed.

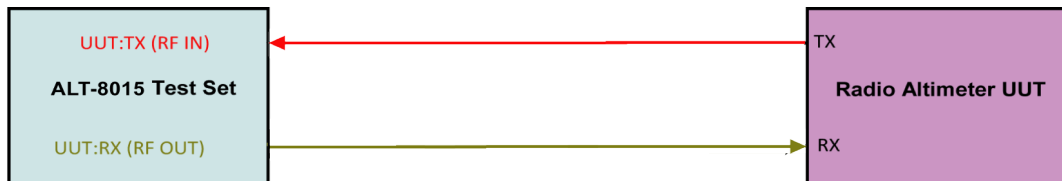

Fig. 4-9 Direct Connection

4.1.4 Antenna Coupler Installation and Connection

Perform the following steps to install the Antenna Coupler:

STEP	PROCEDURE
1.	Place the ALT-8000 within cable length of the aircraft under test radio altimeter antennas.
2.	Connect the 20 ft Low Loss RF Coax Cables to the ALT-8000 UUT:TX/UUT:RX TNC connectors.
3.	Perform Setup procedure (4.1.6).
4.	Select the correct sectional pole lengths that allow support of the Antenna Couplers over the aircraft radio altimeter antennas. Assemble pole sections.
5.	Mount the Antenna Couplers to the end of each completed sectional pole.

NOTE:

For helicopters and low fuselage aircraft, use spring loaded shock instead of gas loaded shock and sectional poles.

6. Press down on each pole assembly until the Gas Shock compresses and locks the retaining clamp. The amount of compression should allow the pole to be raised into place.
7. Refer to Fig. 4-10. Connect the Antenna Coupler's TNC connectors to the RF Coax Cables as indicated.
8. Raise the TX pole assembly and place the (UUT:TX) Antenna Coupler over the TX Radio Altimeter Antenna. When the pole is vertical, release the Gas Shock retaining clamp to apply the preloaded upward pressure on the Antenna Coupler.
9. If there is doubt about which Radio Altimeter Antenna is the TX antenna, select Launch Bar tab to display launch bar. Select Simulation function key to display Simulation Window. Press Run to start test and confirm that a TX Power reading is displayed.

NOTE:

In multiple system installations, the TX/RX antennas for a specific system are aligned in a forward-aft direction. The ALT-8000 will not function correctly if the antenna couplers are placed over the wrong aircraft antennas.

10. Raise the RX pole assembly and place the (UUT:RX) Antenna Coupler over the RX Radio Altimeter Antenna. When the pole is vertical, release the Gas Shock retaining clamp to apply the preloaded upward pressure on the Antenna Coupler.

CAUTION

DO NOT CONNECT ALT-8000 UUT:RX PORT TO RADIO ALTIMETER TX PORT. DAMAGE WILL RESULT TO THE ALT-8000 UUT:RX PORT. MAXIMUM REVERSE POWER: 100mW.

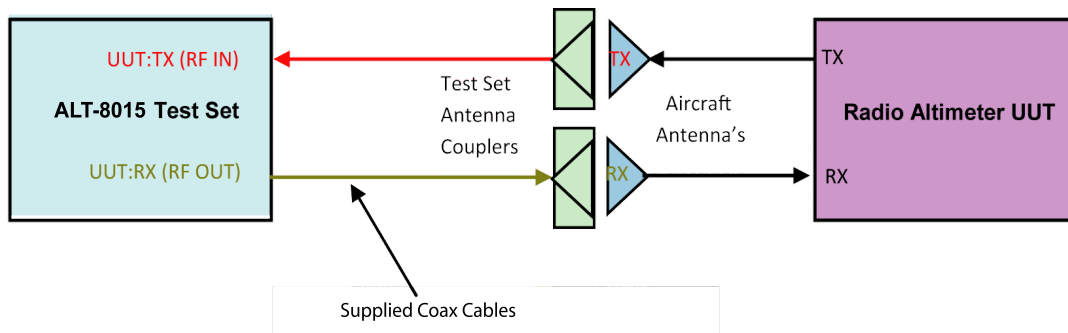

Fig. 4-10 ALT-8000 RF Connections

4.1.5 Feeder Connection

Perform the following steps to install the Antenna Feeders:

STEP	PROCEDURE
1.	Place the ALT-8000 within cable length of the aircraft under test Radio Altimeter Antennas.
2.	Connect the Low Loss RF Coax Cables to the ALT-8000 UUT:TX/UUT:RX TNC connectors.
3.	Perform setup procedure (4.1.6).
4.	Remove the Radio Altimeter TX and RX antennas.
5.	Refer to Fig. 4-11. Connect the UUT:TX RF coax cable to the TX Feeder.
6.	If there is doubt about which Radio Altimeter Feeder cable is the TX Feeder, select Launch Bar tab to display launch bar. Select Simulation function key to display Simulation Window. Press Run to start test and confirm that a TX Power reading is displayed.
7.	Connect the UUT:RX RF coax cable to the RX Feeder.

CAUTION DO NOT CONNECT ALT-8000 UUT:RX PORT TO RADIO ALTIMETER TX PORT. DAMAGE WILL RESULT TO THE ALT-8000 UUT:RX PORT. MAXIMUM REVERSE POWER: 100mW.

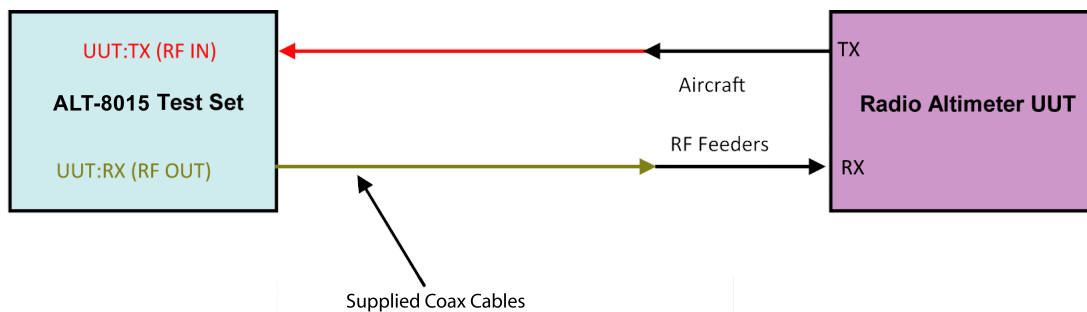

Fig. 4-11 ALT-8000 RF Connections (Feeders)



Fig. 4-12 ALT-8000 Antenna Coupler Installed

4.1.6 Setup

Perform the following steps for setup:

STEP	PROCEDURE
1	Press Power On/Off Key for a minimum of 1 second to power up test set.
2.	Select Test Setup function key to display Test Setup Window.
3.	Confirm the following settings and change as necessary. RF Port <ul style="list-style-type: none">• Connection Type = Coupler (if using antenna couplers) or Direct (connection directly to LRU)• UUT:TX Coupler Loss = Figure in dB marked on TX Antenna Coupler (for Coupler mode only).• UUT:RX Coupler Loss = Figure in dB marked on RX Antenna Coupler (for Coupler mode only). UUT Settings <ul style="list-style-type: none">• UUT Detection Mode = Auto RF Settings <ul style="list-style-type: none">• Level Mode = Auto• UUT:TX Cable Loss = Figure in dB marked on TX cable.• UUT:RX Cable Loss = Figure in dB marked on RX cable. Delay Settings <ul style="list-style-type: none">• AID Mode = Fixed• Fixed AID = Installation AID 0, 20, 40, 57 or 80 ft.

NOTE:

AID Only displayed when connection type is set to Direct.

If connection type is set to Feeder, connection is made to end of feeder (antennas are removed).

CAUTION	UUT:TX PORT MAXIMUM POWER: 300 W, 5 W AVERAGE.
----------------	---

STEP

PROCEDURE

4. Select **Delay Calibration** to display the Delay Calibration screen (Fig. 4-13). This screen starts the calibration procedure for Test Set/RF coaxial cable delay.

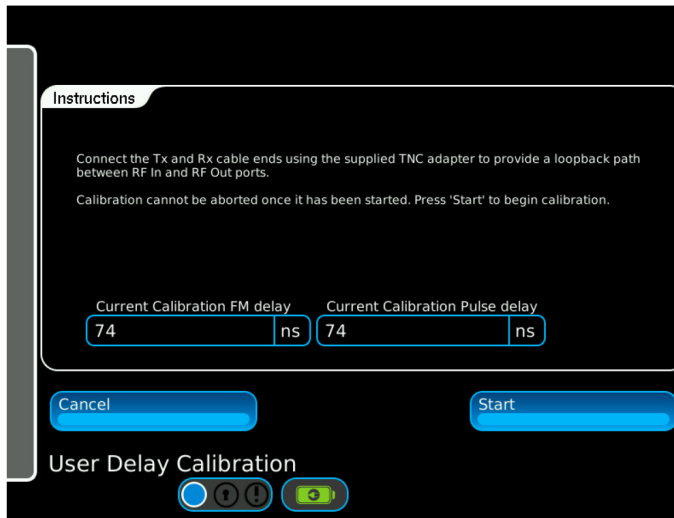

Fig. 4-13 Delay Calibration Screen

5. Connect the ends of the TX and RX cables together using the supplied TNC Connector.
6. Select **Start** to start delay calibration. The calibration process is automatic. When delay calibration is complete the Test Setup screen is displayed.

NOTE:

Delay calibration may not be aborted once started.

7. Disconnect the TNC Connector from the TX and RX cables.
8. Perform Antenna Coupler Installation procedure. If connecting via feeder, remove aircraft altimeter antennas and connect ends of the ALT-8000 TX and RX RF coaxial cables to aircraft feeder cables. If connecting via direct, connect the ends of ALT-8000 TX and RX RF coaxial cables to the TX and RX RF connections on the radio altimeter.
9. Select **Altitude Indicator Zero** key to display Altitude Indicator Zero screen (Fig. 4-14).

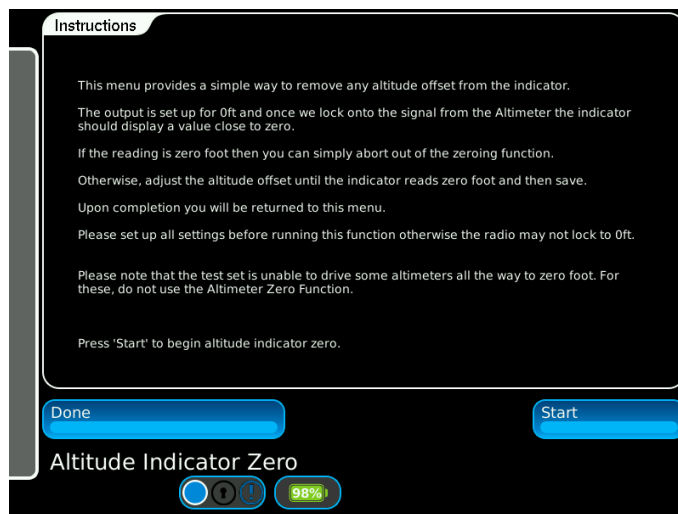

Fig. 4-14 Altitude Indicator Zero Screen

STEP

PROCEDURE

10. Press start to start the Altitude Indicator Zero procedure. Wait until the test set indicates it has a valid signal.

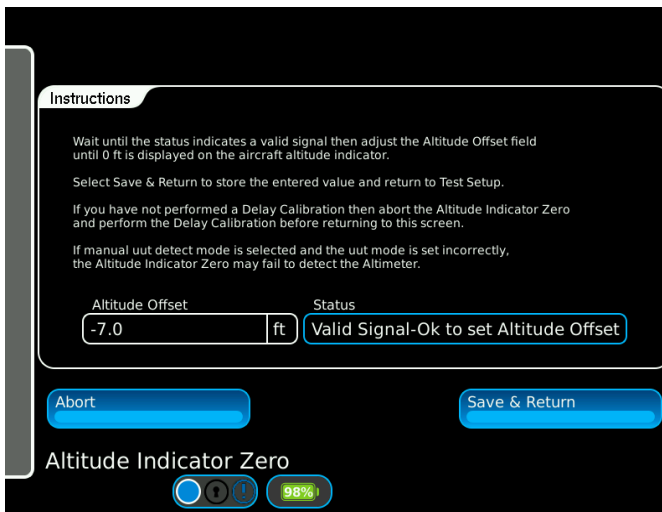

Fig. 4-15 Altitude Indicator Zero Procedure Screen

11. The test set is now simulating 0 ft at the end of the ALT-8000 RF coax cables. To compensate for the aircraft antenna height at touch down, select the **Altitude Offset** field. Using the +/- key or numeric pad, adjust the **Altitude Offset** field until 0 ft is displayed on the aircraft altitude indicator.
12. Select **Save & Return** key to store value and return to the Altitude Indicator Zero Screen window. Select the Done key to return to Test Setup (General Tab). The test set is now ready to perform the Linear Altitude Ramp Test.

4.1.6.A Linear Altitude Ramp Test

The Linear Altitude Ramp Test will perform a linear up and down altitude ramp, verifying adequate UUT loop gain. This is the lowest level of flight-line testing recommended to confirm reported problems, or to verify system operation after LRU replacement.

Perform the following steps to execute the Linear Altitude Ramp Test:

- | STEP | PROCEDURE |
|------|--|
| 1. | <p>Confirm the following settings and change as necessary:</p> <p>Control</p> <ul style="list-style-type: none"> Start Altitude = 0 ft Stop Altitude = 2,500 ft Altitude Rate = 500 ft/min (5 min duration) <p>NOTE:</p> <p>DH trips should be verified on a descending ramp, with a descent rate of 100 ft/min or less, to allow verification of DH indicator and any audible warning.</p> |
| 2. | Select Run key to start simulation. Altitude Pause is displayed. |

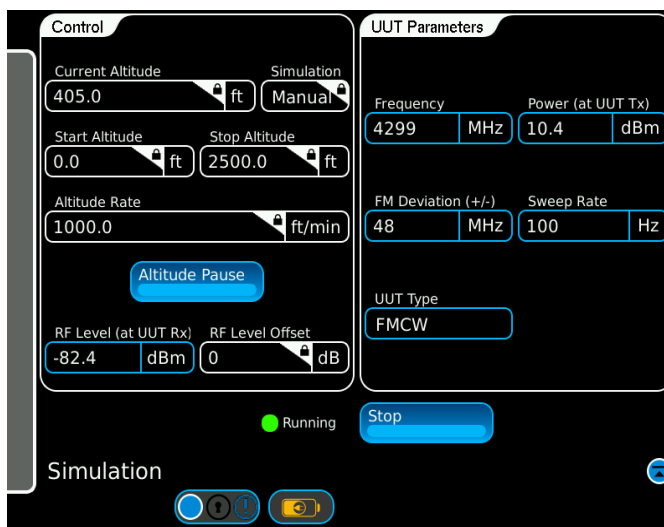

Fig. 4-16 Altitude Pause Key

- Confirm Aircraft altitude indicator tracks altitude smoothly from 0 to 2,500 ft and there is no indicator flag in view.

NOTE:

Sudden indicator display of a ground height (-10 ft) is indicative of an aircraft antenna ground plane bonding problem or RF feeder cable termination problem, resulting in leakage between TX and RX antennas. This will usually manifest at higher altitude when the reflected TX power seen by the receiver falls below the level of leakage.

Control

- Current Altitude = displays current test set simulated altitude
- To pause simulation at any point select **Altitude Pause** key. Altitude may now be slewed manually using Data/Slew Bar or Rotary Knob. The increment units (10 or 1) may be selected by highlighting.

STEP

PROCEDURE

NOTE:

To use the + and - buttons on the Slew Bar, buttons must be pressed and held for a few seconds.

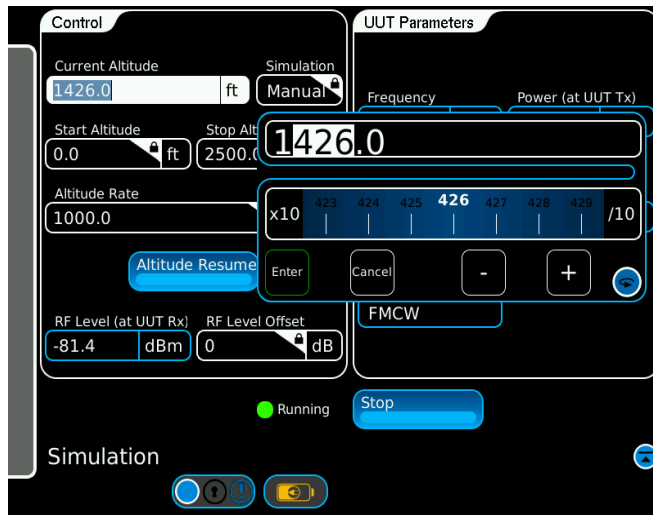

Fig. 4-17 Paused Altitude Rate / Manual Altitude Slew

5. Select **Altitude Resume** key to resume simulation from current altitude.

NOTE:

EFIS displays typically apply variable altitude resolution (i.e., 0 to 100 ft = 2 ft resolution, 100 to 500 ft = 10 ft resolution, > 500 ft = 20 ft resolution).

NOTE:

Some instrument systems will not display altitude ramps starting at altitude descending to zero feet. Use the profile feature to create a suitable test ramp for these systems. Example: 0 to 2,500 ft at 500 ft/min followed by 2,500 to 0 ft at 100 ft/min. The slower descent rate allows the DH trip to be verified.

4.1.6.B Profile Creation

The Profile Altitude Test will execute a sequence of linear altitude ramp legs. Together the legs form a profile, which can simulate a complete approach/landing or departure simulation. Profiles are used to test radio altimeters coupled with auto-land systems.

Perform the following steps to setup an example four leg descent profile:

STEP	PROCEDURE
1.	Press Power On/Off key for a minimum of 1 second to power up test set.
2.	Select Launch Bar tab to display launch bar. Select Profile Setup function key to display Profile Setup Window.
3.	Select Add key to display Add Leg window.
4.	<p>Leg # 1:</p> <p>Select Start Altitude to display numeric pad and enter Start Altitude = 1510 ft, select Enter to confirm parameter.</p> <p>Select Stop Altitude to display numeric pad and enter Stop Altitude = 1500 ft, select Enter to confirm parameter.</p> <p>Select Altitude Rate to display numeric pad and enter Altitude Rate= 60 fpm, select Enter to confirm parameter.</p> <p>Select Enter to confirm leg. Leg #1 will now be displayed in the Simulation Legs table.</p>
5.	Select Add Leg key to display Add Leg window
6.	<p>Leg # 2:</p> <p>Select Start Altitude to display numeric pad and enter Start Altitude = 1500 ft, select Enter to confirm parameter.</p> <p>Select Stop Altitude to display numeric pad and enter Stop Altitude = 1,000 ft, select Enter to confirm parameter.</p> <p>Select Altitude Rate to display numeric pad and enter Altitude Rate= 1500 fpm, select Enter to confirm parameter.</p> <p>Select Enter to confirm leg. Leg #2 will now be displayed in the Simulation Legs table.</p>
7.	Select Add Leg key to display Add Leg window.
8.	<p>Leg # 3:</p> <p>Select Start Altitude to display numeric pad and enter Start Altitude = 1,000 ft, select Enter to confirm parameter.</p> <p>Select Stop Altitude to display numeric pad and enter Stop Altitude = 10 ft, select Enter to confirm parameter.</p> <p>Select Altitude Rate to display numeric pad and enter Altitude Rate= 2970 fpm, select Enter to confirm parameter.</p>

STEP

PROCEDURE

- Select **Enter** to confirm leg. Leg #3 will now be displayed in the Simulation Legs table.
9. Select **Add** key to display Add Leg window.
10. **Leg # 4:**
 Select **Start Altitude** to display numeric pad and enter Start Altitude = 10 ft, select **Enter** to confirm parameter.
- Select **Stop Altitude** to display numeric pad and enter Stop Altitude = -5 ft, select **Enter** to confirm parameter. **NOTE:** In a de-rotated configuration, radio altimeter will display a negative altitude.
- Select **Altitude Rate** to display numeric pad and enter Altitude Rate = 90 fpm, select **Enter** to confirm parameter.
- Select **Enter** to confirm leg. Leg #4 will now be displayed in the Simulation Legs table.
11. To store the profile, select **Store Current Profile** key to open alpha numeric pad and enter profile name (e.g., "Approach") . Name may be up to 20 characters long. Select **Enter** when complete. The new profile name will now appear in profile list in Manage Profiles and also displayed in the Profile Name field.

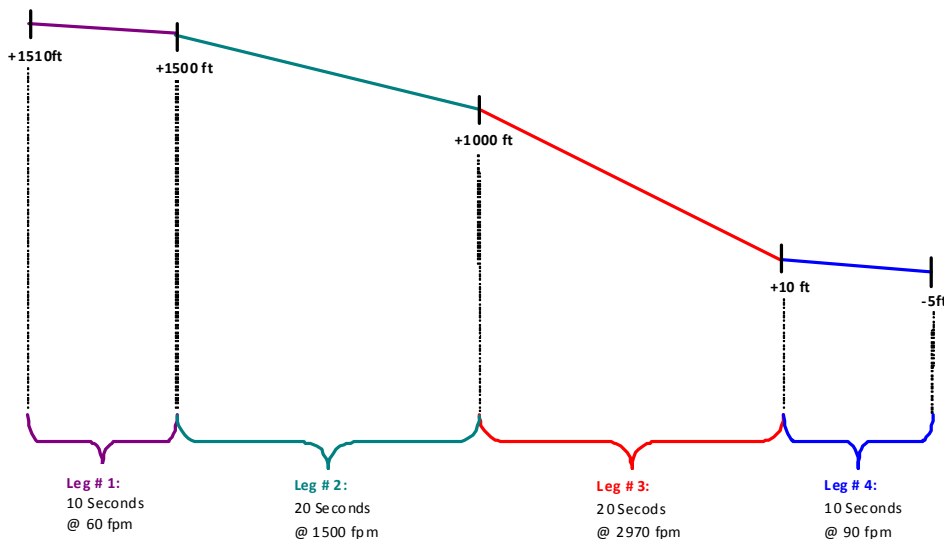

Fig. 4-18 Multi-leg Profile Example

4.1.6.C Profile Altitude Test

Perform the following steps to setup a Profile Altitude Test:

STEP	PROCEDURE
1.	Perform the Setup procedure (4.1.6).
2.	Select Launch Bar tab to display launch bar. Select Profile Setup function key to display Profile Setup window.
3.	Select Recall Profile key to display Load Profile window. Select desired profile listed in profile table and select Recall . Recalled profile will now be resident in memory and ready for execution.
4.	Select Launch Bar tab to display launch bar. Select Simulation function key to display Radio Altimeter Function Test Window.
5.	Confirm the following setting and change as necessary: <ul style="list-style-type: none">• Control Simulation = Profile
6.	Select Run key to start simulation.
7.	The Start Altitude, Stop Altitude and Altitude Rate will be displayed for the current leg. Current Altitude is also displayed.
8.	To view the overall progress of the profile execution, the Profile Setup function window displays a graphical plot of the simulated altitude versus time.

4.1.6.D UUT Parametric Tests

Although the Auto RF Level mode ensures that loop gain is verified and system integrity is verified, there are times when it is desirable to review the parametric performance of an LRU, particularly when intermittent problems have been reported.

NOTE:

Manufacturers specifications should always be referred to.

LRU Review Guidelines

Frequency: Varies between LRRRA models. Typically centered at 4.3 GHz +/-70 MHz.

FM Deviation: Varies between LRRRA models. FM/CW types typically 100 to 140 MHz.

Sweep Rate: Varies between LRRRA models. FM/CW types typically 50 to 160 Hz.

NOTE:

In a dual or triple LRRRA installation, each LRU may have a different sweep rate set, to avoid cross channel interference.

Power: Varies between LRRRA models. FM/CW types typically 150 mW to 1 W.

NOTE:

Manufacturers power specifications are stated at the LRU, so expect power levels to be measured at the Aircraft Antenna.

Typical Aircraft Antenna gains are 10 dBi (radiated). Because the ALT-8000 antenna couplers couple in the near field of the antenna, this gain will not be realized.

In cases where a Linear Altitude Ramp Test has been performed, with RF Level set to Auto and a tracking failure occurs (i.e., indicator flag in view) a power measurement can be made to determine if the problem is in the TX path and where in the TX path.

Possible TX Path Problems

- LRU TX Power low
- RF Feeder cable
 - a. Excessive loss or bad VSWR due to coax cable water ingress.
 - b. Bad connector Termination
- TX Antenna Bad
 - a. Mechanical damage
 - b. Lightning strike
 - c. Corrosion due to water ingress

If a power test at the aircraft antenna is satisfactory, the RX path should be investigated.

Possible RX Path Problems

- LRU RX sensitivity low
- RF Feeder cable Bad
 - a. Excessive loss or bad VSWR due to coax cable water ingress.
 - b. Bad connector Termination
- RX Antenna Bad
 - a. Mechanical damage
 - b. Lightning strike
 - c. Corrosion due to water ingress

Removal of both TX and RX aircraft antennas and connection of the ALT-8000 via feeder, will determine if the antennas were faulty or if the problem still persists.

If the aircraft antennas are removed, the RF feeder cables should be checked for connector termination soundness and any signs of water ingress, which typically discolors the feeder cable sheath. Antennas should be inspected for corrosion that may effect ground plane bonding.

Parametric Test Procedure

STEP	PROCEDURE
1.	Perform setup procedure (4.1.6). Confirm the following Control settings and change as necessary: <ul style="list-style-type: none">• Start Altitude = 0 ft• Stop Altitude = 2,500 ft• Altitude Rate = 1,000 ft/min (2.5 mins duration)
2.	Select Run key to start simulation.
3.	The UUT Parameters section displays the measurements (Fig. 4-18). Perform the following steps to perform a receiver sensitivity test.

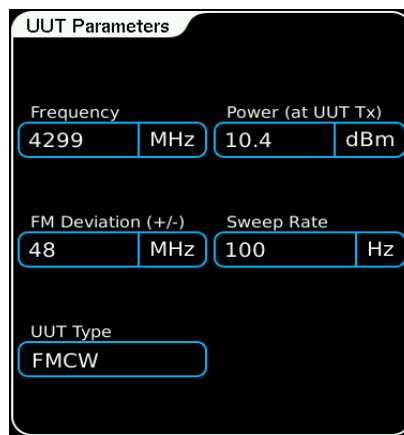

Fig. 4-19 UUT Parameters (part of the Simulation Function Window)

Receiver Sensitivity Test Procedure

STEP	PROCEDURE
1.	Perform setup procedure (4.1.6).
2.	Select Launch Bar tab to display launch bar. Select Test Setup function key to display Test Setup Window. <ul style="list-style-type: none">• RF Settings Level Mode = Manual
3.	Select Launch Bar tab to display launch bar. Simulation function key to display Radio Altimeter Function Test Window.
4.	Confirm the following setting and change as necessary: <ul style="list-style-type: none">• Start Altitude = 2,500 ft• Altitude Rate = 0 ft/min
5.	Select Run key to start simulation.
6.	Select RF Level , observe Altitude Indicator and decrement RF Level until Indicator flags. The RF Level setting represents the installed receiver sensitivity.

NOTE:

LRRA LRUs typically reduce their receiver sensitivity as altitude decreases to avoid false locks. Testing at typically 2,500 ft altitude should ensure that maximum receiver sensitivity is measured.

4.1.7 Identifying Installed Software Version

Perform the following steps to identify the software version installed in the ALT-8000.

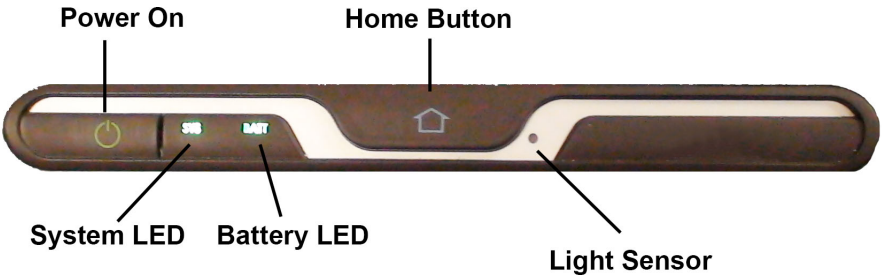
- | STEP | PROCEDURE |
|------|--|
| 1. | Press the On/Off button to turn the test set on. |
- 
- The diagram shows the top edge of the ALT-8000 device. From left to right, it features a Power On button (a green circle with a vertical line), a System LED (a small green light), a Battery LED (a small red light), a Home Button (a house-shaped icon), and a Light Sensor (a small red dot). Labels with leader lines point to each of these components.
- Allow the test set to complete the boot process, approximately 3 to 5 mins.
 - Open the Launch Bar, if necessary, by touching the light gray bar located on the left side of the user interface and scroll down to the System function key if it is not displayed.
 - Touch the System function key to open the System pull down menu and select System Update.
 - In the Version window the unit serial number and currently installed software version number is displayed.

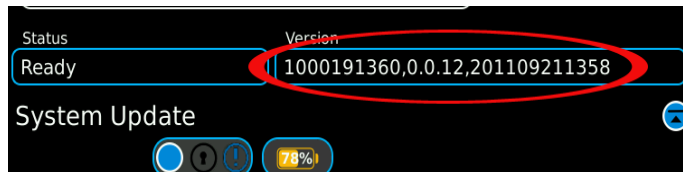

In this example, the serial number is 1000191360, the software version is 0.0.12 and the software was released on 2011/09/21 at 1358.

4.1.7.A Options Function Window

Selecting Options from the System sub-menu will display the Options Function Window.

The Options Function Window provides control for installing or removing options and displays currently installed options.

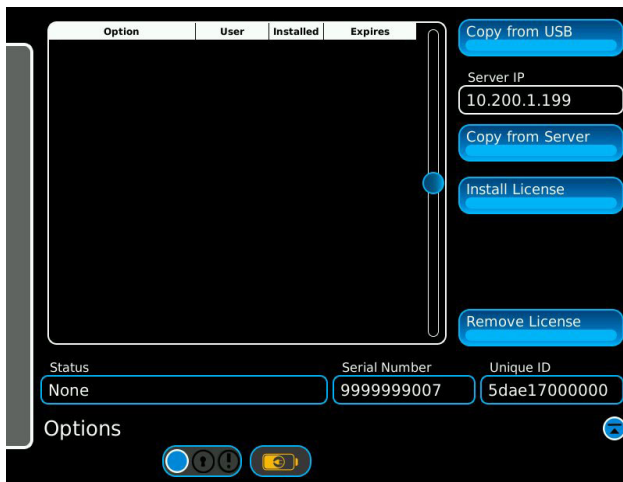

Fig. 4-20 Options Function Window

Control Component	Description
Copy from USB	Initiates Copy of Option License files from a USB memory device installed in USB Host 1 or USB Host 2.
Copy from Server	Initiates Copy of Option License files from a server. NOTE: Factory use only.
Install License	Installs Option License files that have been copied to the internal memory.
Remove License	Removes Option License files. NOTE: This will permanently remove installed options.

Display Component	Description
Status	Displays status messages to inform the user of progress or errors.
Serial Number	Displays the serial number of the ALT-8000.
Unique ID	Displays the Unique ID of the ALT-8000.
Option	Displays installed options.
User	Displays User log-in ID. NOTE: Default is ALL if no user login required.
Installed	Displays date option was installed.
Expires	Displays date option expires. NOTE: If no expiration date displays -1.
Server IP	Numeric Pad: Enter the Server IP address.

THIS PAGE INTENTIONALLY LEFT BLANK.

Chapter 5 - Maintenance

5.1 INTRODUCTION

5.1.1 Visual Inspections

Visual inspections should be performed periodically depending on operating environment, maintenance and use.

5.1.2 External Cleaning

STEP	PROCEDURE
1.	Clean front panel buttons and display face with soft lint-free cloth. If dirt is difficult to remove, dampen cloth with water and a mild liquid detergent.
2.	Remove grease, fungus and ground-in dirt from surfaces with soft lint-free cloth dampened (not soaked) with isopropyl alcohol.
3.	Remove dust and dirt from connectors with soft-bristled brush.
4.	Cover connectors, not in use, with suitable dust cover to prevent tarnishing of connector contacts.
5.	Clean cables with soft lint-free cloth.
6.	Paint exposed metal surface to avoid corrosion.

5.2 MAINTENANCE PROCEDURES

5.2.1 Battery Replacement

Perform the following steps to replace battery:

STEP	PROCEDURE
1.	Verify the ALT-8000 is OFF and not connected to AC power via the AC Adapter.
2.	Place the ALT-8000 on a flat surface, lower side up.
3.	Lift the battery cover Pull Tab to a vertical position to release the Battery Cover and lift away from the Case Assembly.
4.	Remove the battery from the battery housing (Fig. 5-1).
5.	Install new battery in the battery housing.
6.	Replace the battery cover on the case assembly by locating the lipped end of the cover in the case assembly. Lift the pull tab and push the battery cover down, ensuring the catch engages. Release the pull tab and ensure battery lays flat inside the recess.

WARNING

DISPOSE OF OLD BATTERY ACCORDING TO LOCAL STANDARD SAFETY PROCEDURES.



Fig. 5-1 Battery Replacement

5.2.2 ALT-8000 Software Update

Perform the following steps to Update ALT-8000 Software via the USB port using a USB memory device*:

STEP	PROCEDURE
1.	Using your PC, obtain the latest software update zip file from VIAVI.
2.	Insert a USB memory device* into the PC and copy the zip file to the root directory of the USB memory device.
3.	Unzip the file onto the root directory of the USB memory device.
4.	Upon completion you will have an VIAVI/Common/ directory that will contain all the .rpm files for the update.
5.	Safely remove the USB memory device from the PC.
6.	Power up the ALT-8000.
7.	Once booted, select System then select System Update from the drop down menu.
8.	Insert the USB memory device in USB Host 1 Port.

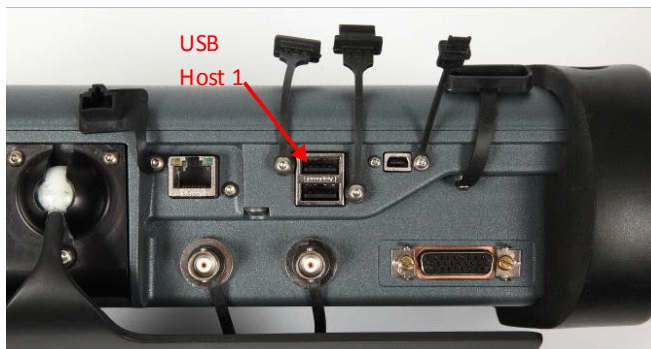

Fig. 5-2 USB Ports

9. Wait 5 to 10 seconds for the device to be recognized and select **Copy from USB.****
The status screen should indicate 'Copying Software Update'. This step may take several minutes
10. The window will show any new rpm files that need to be updated.
11. Select **Install Software** and the update will start and the progress screen appears.
12. When prompted, remove the USB memory device and Reboot.

* Recommended USB memory Device: VIAVI PN 67327.

** If you experience a USB Error when trying to copy from USB, the USB memory device being used may not be compatible with the ALT-8000.

5.2.3 System Configuration Function Window

The System Configuration Function window is accessible via the Launch Bar System function key, as a sub selection. System Configuration displays five selectable tabs across the top of the screen. Status, Hardware, UI Options, Network and Date/Time.

5.2.3.A Status

The Status tab displays memory status, operating time, hardware module temperatures and provide internal SD card formatting control.

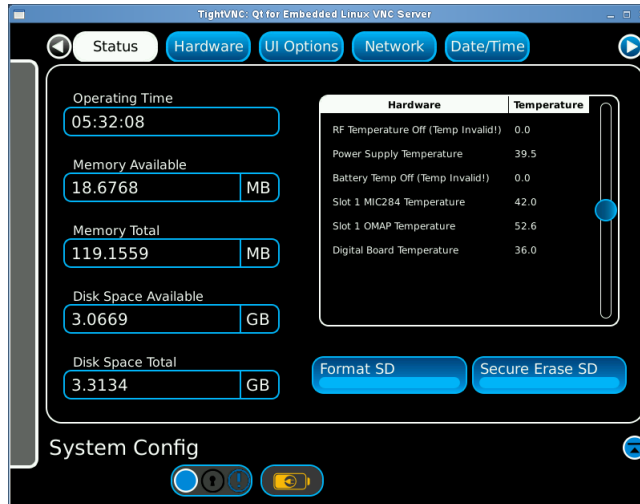

Fig. 5-3 System Configuration - Status

Display Component	Description
Operating Time	Displays the total operating time in hrs:mins:secs since power up.
Memory Available	Displays memory available to software resources in MB.
Memory Total	Displays total test set memory in MB.
Disk Space Available	Displays remaining disk space available in GB for settings and profile storage.
Disk Space Total	Displays total test set disk space in GB.
RF Temperature	Displays the current RF card temperature in degrees Celsius. RF Temperature only displays if RF is generated.
Power Supply Temperature	Displays the current power supply module temperature in degrees Celsius.
Battery Temperature	Displays the current battery pack temperature in degrees Celsius.

Display Component	Description
Slot 1 MIC284 Temperature	Displays the current PXI slot 1 controller MIC284 temperature in degrees Celsius.
Slot 1 OMAP Temperature	Displays the current PXI slot 1 controller OMAP processor temperature in degrees Celsius.
Digital Board Temperature	Displays the current PXI digital board temperature in degrees Celsius.

Control Component	Description
Format SD	Formats the internal SD memory card overwriting all stored settings and profile data. NOTE: The user will be prompted YES or NO prior to execution of formatting. Caution: Formatting will result in complete irretrievable loss of settings and profile data.
Secure Erase SD	Completely erases the contacts of the SD card. This can take a couple of hours to complete. Settings and Profiles will no longer be accessible.

5.2.3.B Hardware

The Hardware tab displays hardware module/board identification, version and software revision numbers for configuration control purposes.

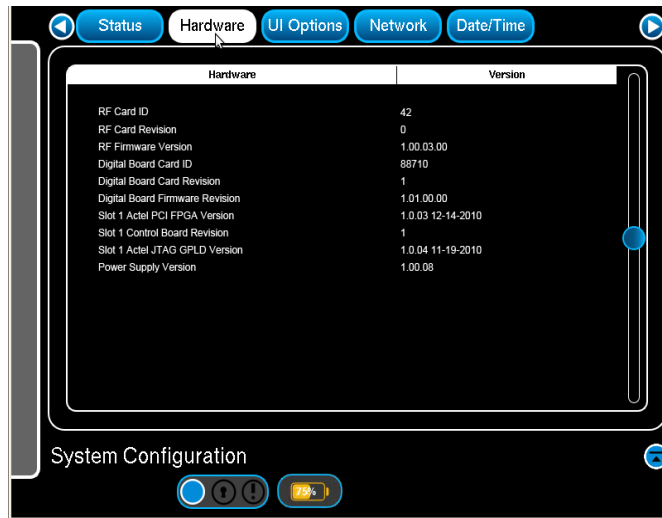

Fig. 5-4 System Configuration - Hardware

Display Component	Description
RF Card ID	Displays RF card identification number.
RF Card Revision	Displays RF card revision number.
RF Firmware Version	Displays RF card firmware revision number.
Digital Board Card ID	Displays digital board card ID number.
Digital Board Card Revision	Displays digital board card revision number.
Digital Board Firmware Revision	Displays digital board firmware revision number.

Slot 1 Actel PCI FPGA Version	Displays slot1 Actel PCI FPGA version number and date.
Slot 1 Control Board Revision	Displays slot 1 control board revision number.
Slot 1 Actel JTAG GPLD Version	Displays slot1 Actel JTAG GPLD version number and date.
Power Supply Version	Displays power supply version number.

5.2.3.C UI Options

The UI Options tab controls the screen back light level and touch screen calibration utility.

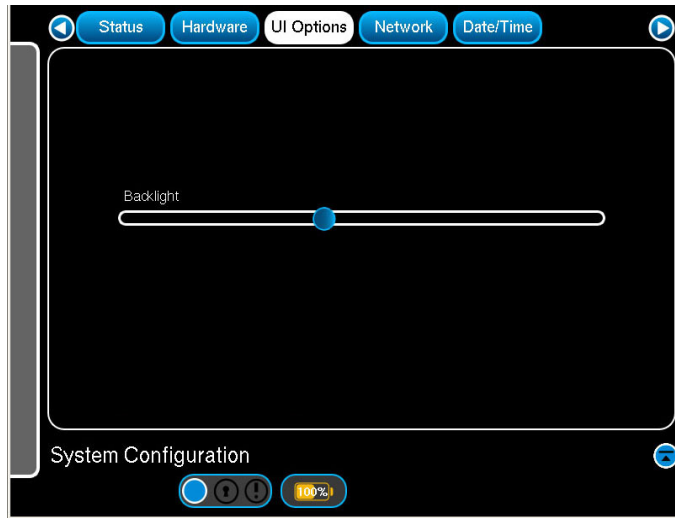

Fig. 5-5 System Configuration – UI Options

Control Component	Description
Backlight	Move the slider to the right to increase backlight level. Move the slider to the left to reduce backlight level.

5.2.3.D Network

The Network tab controls the test set Ethernet adaptor local area connection settings. The Ethernet bus is used for remote control of the test set.

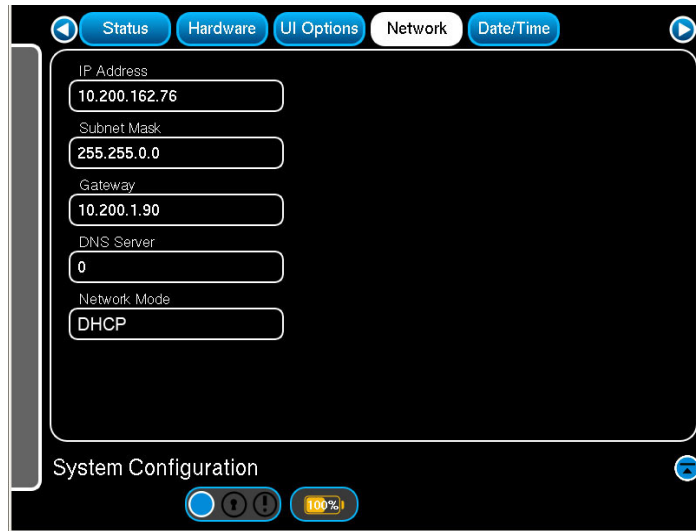

Fig. 5-6 System Configuration – Network

Control Component	Description
IP Address	Numeric pad: IP address example entry in the format 10.200.162.76 .
Subnet Mask	Numeric pad: Subnet mask example entry in the format 255.255.255.0 .
Gateway	Numeric pad: Gateway example entry in the format 10.200.1.90 . NOTE: This field is only selectable with Network Mode = DHCP
DNS Server	Connection specific Domain Name Server suffix. NOTE: Reserved for future use.
Network Mode	Drop down menu: Selections Network Off – Disables Ethernet adaptor. Static IP - Uses entered static IP address. DHCP – Uses dynamically allocated address from DHCP server.

5.2.3.E Date/Time

The Date/Time tab controls the test set date /time clock parameters.

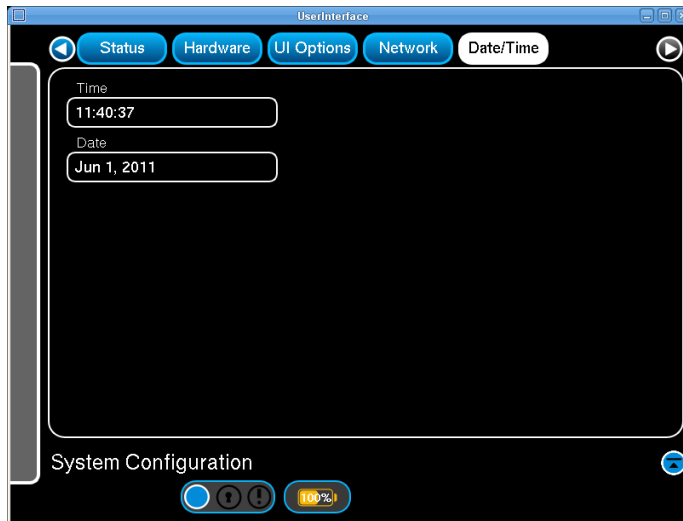

Fig. 5-7 System Configuration – Date/Time

Control Component	Description
Time	Numeric pad: Time entry in the 12 or 24 Hour format HH:MM:SS
Date	Numeric pad: Date entry in the format MM:DD:YYYY

5.2.4 Maintenance Function Window

The Maintenance Function Window is accessible via the Launch Bar. The Maintenance Function Window provides access to Diagnostics, Calibration and System Info procedures and information.

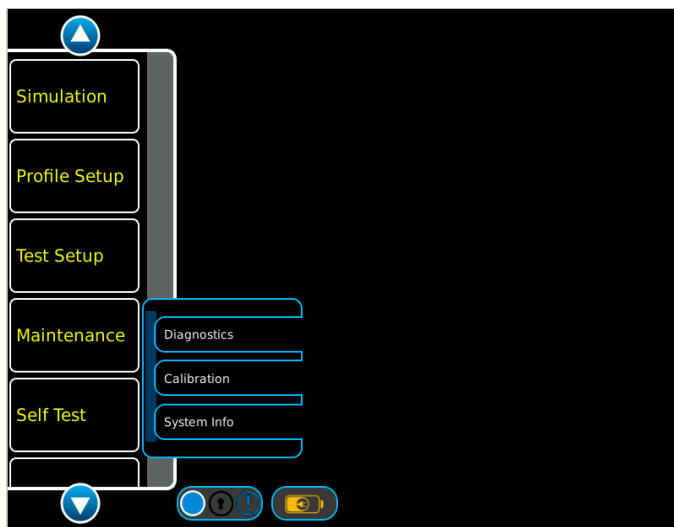

Fig. 5-8 Maintenance Function Window

5.2.5 Diagnostics Function

The Diagnostics function provides control for generating and receiving test signals, with specific power and frequency parameters.

5.2.5.A Transmit Function

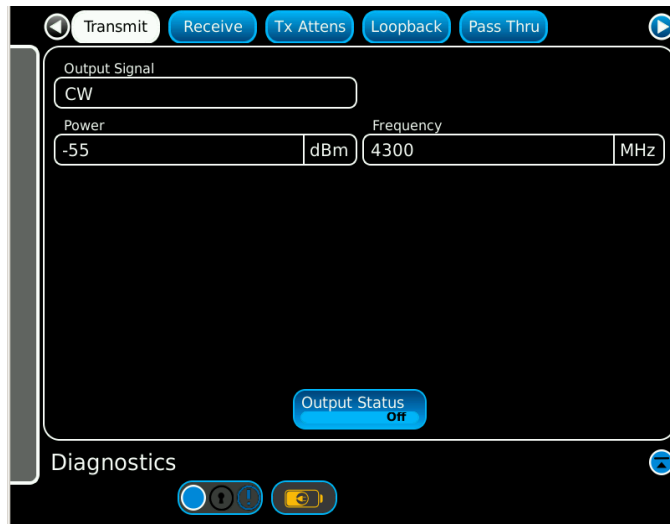

Fig. 5-9 Transmit Function

Control Component	Description
Output Signal	Drop down menu: Selections CW, FMCW or Pulse.
Power	Numeric pad: Power in dBm. Range -76 dBm to +17 dBm in 1 dB increments.
Frequency	Numeric pad: Frequency in MHz. Range 4200 to 4400 in 1 MHz increments.
Output Status	Selections On - generates test signals. Off - turns test signals off.
PRF	Numeric pad: Rate in Hz. Range 2,000 Hz to 30,000 Hz.
Pulse Width	Numeric pad: Pulse Width in ns. Range 20 ns to 400 ns.

5.2.5.B Receive Function

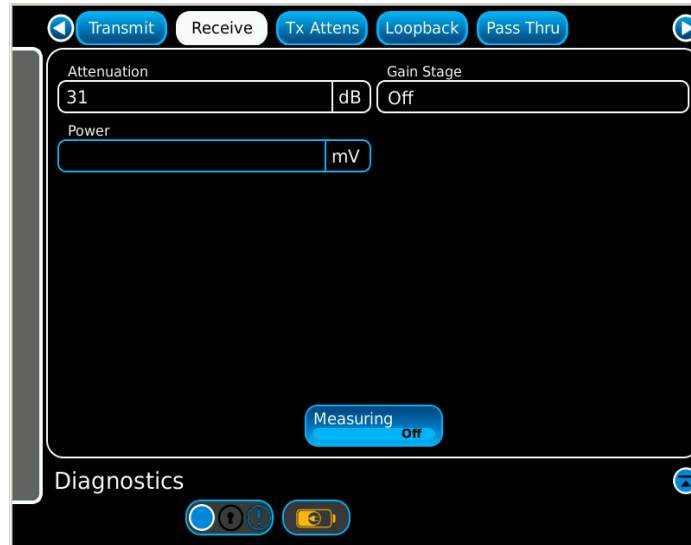

Fig. 5-10 Receive Diagnostics

Control Component	Description
Input Attenuation	Numeric pad: Attenuation in dB. Range 0 to 31 in 1 dB increments.
Gain Stage	Drop down menu: Selections OFF, ON. Turn on/off the 24 dB Gain Stage.
Power	Power displayed in millivolts.
Measuring	Activates measuring function.

NOTE:

Pulse signals or gated FMCW signals are not currently supported in receive diagnostics mode.

5.2.5.C Tx Attens Function

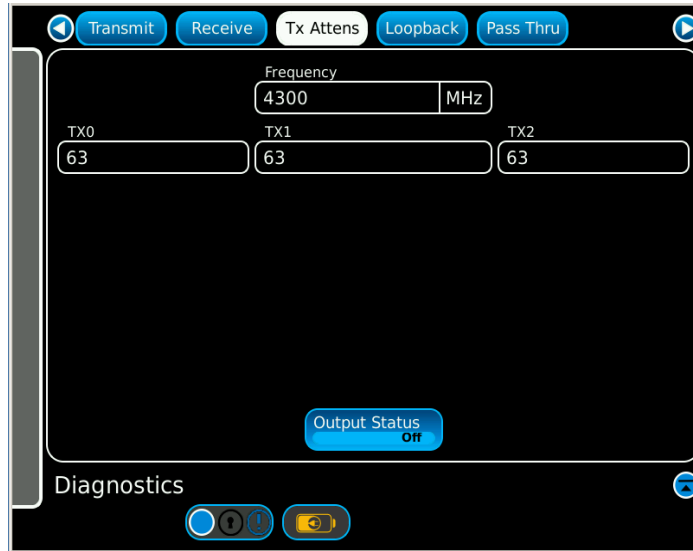

Fig. 5-11 Tx Attens Screen

Control Component	Description
Frequency	Numeric pad: Frequency in MHz. Range 4200 to 4400 in 1 MHz increments.
TX0, TX1, TX2	Numeric pad: TX Attenuation in half dB steps. Ex: setting 31 gives 15.5 dB attenuation. Range 0 to 63 (0 to 31.5 dB)
Output Status	Selections On - generates test signals. Off - turns test signals off.

5.2.5.D Loopback

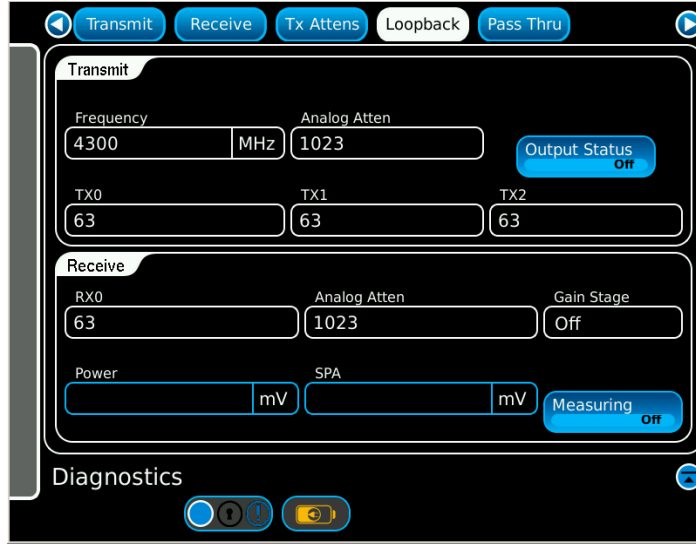

Fig. 5-12 Loopback

Control Component	Description
Frequency	Numeric pad: Frequency in MHz. Range 4200 to 4400 in 1 MHz increments.
Analog Atten	Numeric pad: TX analog attenuation. Range is 0 to 1023. Larger values give larger attenuation.
TX0, TX1, TX2	Numeric pad: TX Attenuation in half dB steps. Ex: setting 31 gives 15.5 dB attenuation. Range 0 to 63 (0 to 31.5 dB)
Output Status	Selections On - generates test signals. Off - turns test signals off.
RX0	Numeric pad: Attenuation in half dB steps. Ex: setting 31 gives 15.5 dB attenuation. Range 0 to 63 (0 to 31.5 dB)
Analog Atten	Numeric pad: RX analog attenuation. Range is 0 to 1023. Larger values give larger attenuation.
Gain Stage	Drop down menu: Selections OFF, ON. Turn on/off the 24 dB Gain Stage.
Power	Power displayed in millivolts.
SPA	Spectrum Analyzer circuit power displayed in millivolts.
Measuring	Activates measuring function.

5.2.5.E Pass Thru

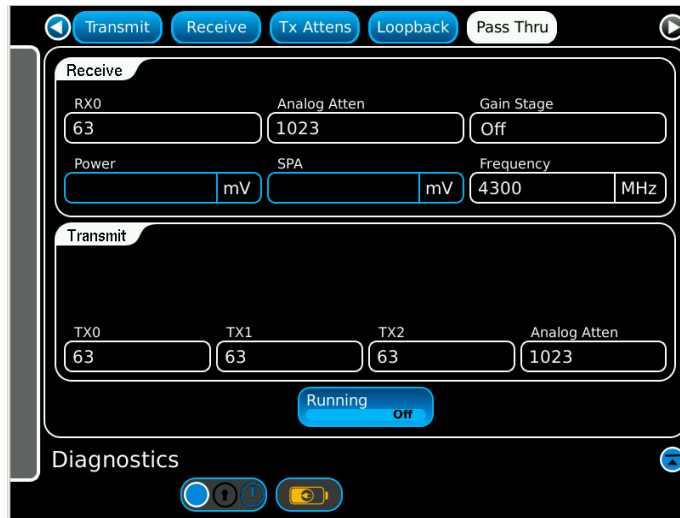

Fig. 5-13 Pass Thru

Control Component	Description
RX0	Numeric pad: Attenuation in half dB steps. Ex: setting 31 gives 15.5 dB attenuation. Range 0 to 63 (0 to 31.5 dB)
Analog Atten	Numeric pad: RX analog attenuation. Range is 0 to 1023. Larger values give larger attenuation.
Gain Stage	Drop down menu: Selections OFF, ON. Turn on/off the 24 dB Gain Stage.
Power	Power displayed in millivolts.
SPA	Spectrum Analyzer circuit power displayed in millivolts.
Frequency	Numeric pad: Frequency in MHz. Range 4200 to 4400 in 1 MHz increments.
TX0, TX1, TX2	Numeric pad: TX attenuation in half dB steps. Ex: setting 31 gives 15.5 dB attenuation. Range 0 to 63 (0 to 31.5 dB)
Analog Atten	Numeric pad: TX analog attenuation. Range is 0 to 1023. Larger values give larger attenuation.
Running	Enable/Disable power output and receive measurements.
DDS0, DDS1	Numeric pad: DDS value to write to hardware to simulate altitude. Range -200 to 20,000. Usually set identical values when driving a FMCW altimeter.

5.2.6 System Info Function Window

The System Info function window is accessible via the Launch Bar Maintenance function key, as a sub selection. System Info displays the hardware status of the Receive LO, Tracking Synth, SPA, Transmit LO, Offset Synth and DPLL. The indicators display clear when the respective loops are locked.

NOTE:

No or very low RF input to the test set will cause the Tracking Synth and DPLL loops to indicate unlocked.

If any indicator displays red, any UUT parameters displayed may be invalid.

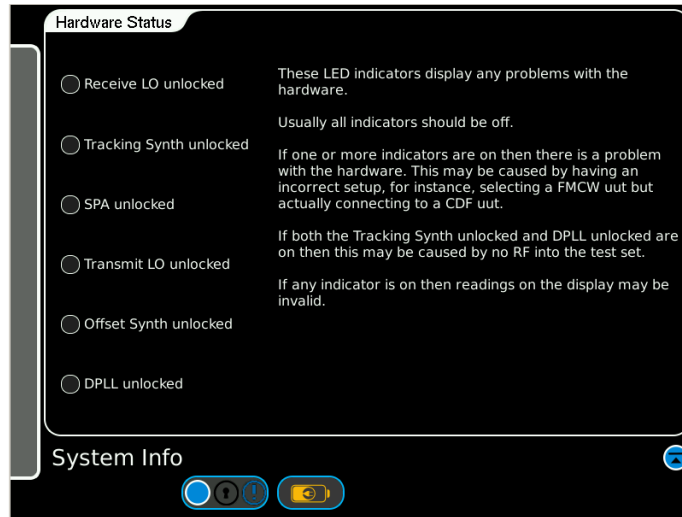

Fig. 5-14 System Info

Display Component	Description
Receive LO unlocked	Displays red when the Receiver Local Oscillator is unlocked.
Tracking Synth unlocked	Displays red when the Tracking Synth is unlocked.
SPA unlocked	Displays red when the SPA is unlocked.
Transmit LO unlocked	Displays red when the Transmit LO is unlocked.
Offset Synth unlocked	Displays red when the Offset Synth is unlocked.
DPLL unlocked	Displays red when the DPLL is unlocked.

Chapter 6 - Principles of Operation

6.1 PRINCIPLES OF OPERATION

6.1.1 ALT-8000 Test Operation

FMCW Radio Altimeters

The ALT-8000 Test-Set analyzes the transmitted signal from a FMCW radio altimeter to derive its waveform parameters. Test-set calculates the required adjustment on received signal based on user inputs and digitally generates the echo signal to test the DUT response in multiple aspects.

For conventional FMCW signal, the Test-Set dynamically adds an adjustable frequency offset to the received signal and then generates the echo signal with a controlled power level.

For constant frequency difference FMCW signal, the Test-Set uniformly adds an adjustable frequency offset to the received signal and then generates the echo signal with a controlled power level.

Pulse Radio Altimeters

The ALT-8000 Test-Set analyzes the transmitted signal from a FMCW radio altimeter to derive its waveform parameters. Test-set calculates the required time delay based on user inputs and digitally controls the time and power level of echo pulses to be transmitted to the DUT.

6.1.2 Radio Altimeters

Low-Range Radio Altimeters (LRRRA), are important safety and navigational tools in aircraft, which apart from displaying altitude above ground, also provide altitude inputs into other key avionics safety systems such as TCAS and GPWS (Ground Proximity Warning System) as well as auto-land systems.



Fig. 6-1 Typical FM/CWLRRA System Components
(ARINC type square antenna shown)

Radio Altimeter Types

There are generally two types operating in the allocated 4.2 to 4.4 GHz band, FM/CW and Pulse Modulated. The FM/CW type also has two variants; Conventional FM/CW and Constant Difference Frequency (CDF) FM/CW.

For air transport applications there are two applicable ARINC standards for LRRRA; ARINC 552 and ARINC 707.

ARINC 552 is an older standard that utilizes a DC Altitude output to indicators and other systems. Several relay based Altitude Trips are also provided to provide discrete switching to systems such as auto-land, at predetermined altitudes.

ARINC 707 is a later digital avionics standard that provisions altitude data either on an ARINC 429 data bus or an ARINC 707 bi-phase bus. There are two data word formats; Label 164 (binary) and Label 165 (BCD). Digital Auto-land systems receive the altitude data from the LRRRA and trip points are processed internally.

6.1.3 FM/CW Radio Altimeter

The main application is for instrument-based approaches and landings for larger commercial aircraft, although they are also suitable for smaller aircraft, military aircraft and even unmanned air vehicles (UAVs). All of these radio altimeters cover the range from 0 to 2500 ft and it is not uncommon for ARINC types to extend to 5,000 (ARA-52A) or 8,000 (LRA-900) ft. Some military types such as the AN/APN-232 extend to 50,000 ft.

Refer to Fig. 6-2. Typically separate transmit and receive antennas are required. Transmitter power ranges typically 10 mW (+10 dBm) General Aviation Type and 500 mW (+27 dBm) to 1W (+30 dBm). The directivity of both transmit and receive antennas is limited to about 10 dBi to allow the operation of the radio altimeter at moderate pitch and bank angles of the aircraft.

For correct operation, the receiving antenna should detect only the reflected signal from the ground and not the radio signal coming directly from the transmitting antenna. The two antennas must be widely separated to avoid crosstalk.

The carrier frequency of the transmitter is swept continuously in a given frequency range. Since the received signal is delayed, the receive frequency differs from the transmitter. If the transmitter frequency rate of change is constant, the delay and altitude are directly proportional to the measured frequency difference between the transmitter and receiver. The accuracy and resolution of the FM/CW type radio altimeters is usually limited to a few feet due to the limited availability of bandwidth (200 MHz) in the 4.3 GHz range.

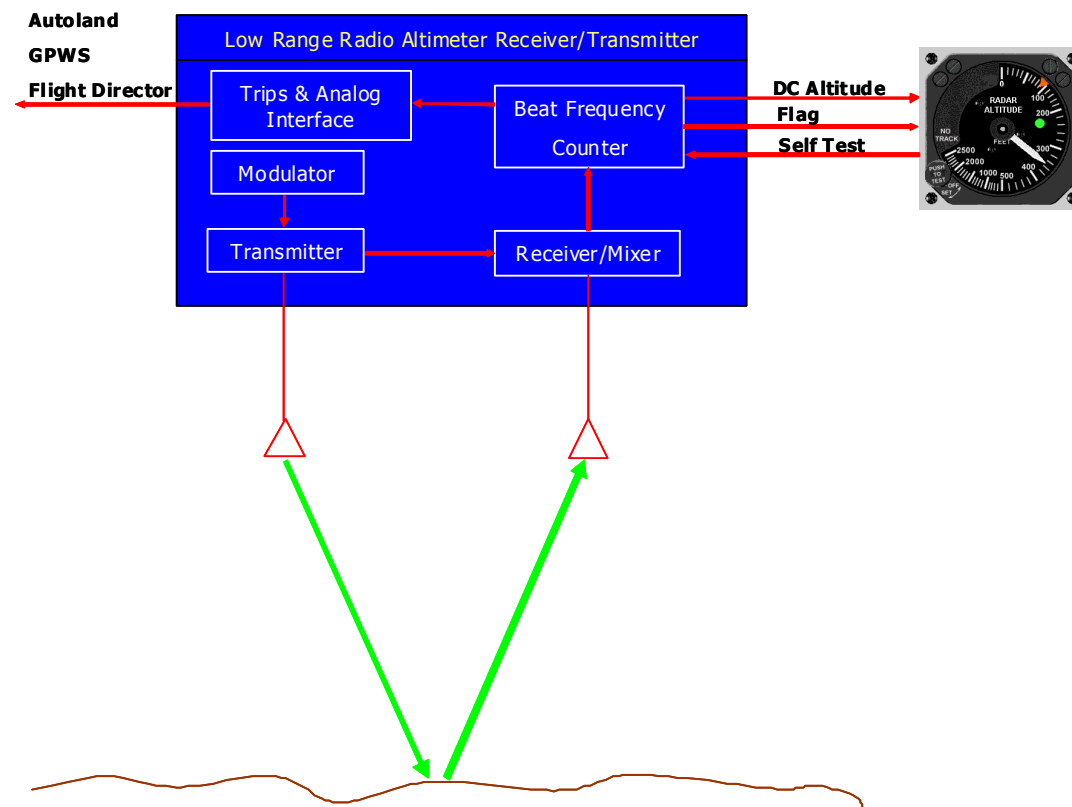

Fig. 6-2 Simplified FM/CW Radio Altimeter

6.1.3.A Conventional FM/CW Radio Altimeters

The sweep waveform is triangular and both slopes are typically used for the altitude measurement to compensate for the Doppler shift due to the vertical speed of the aircraft. The sweep frequency is usually between 50 and 300 Hz. The higher limit is imposed by the receiver thermal noise, the lower limit is the ability of the radio altimeter to eliminate the Doppler shift in the case of a descending or climbing aircraft.

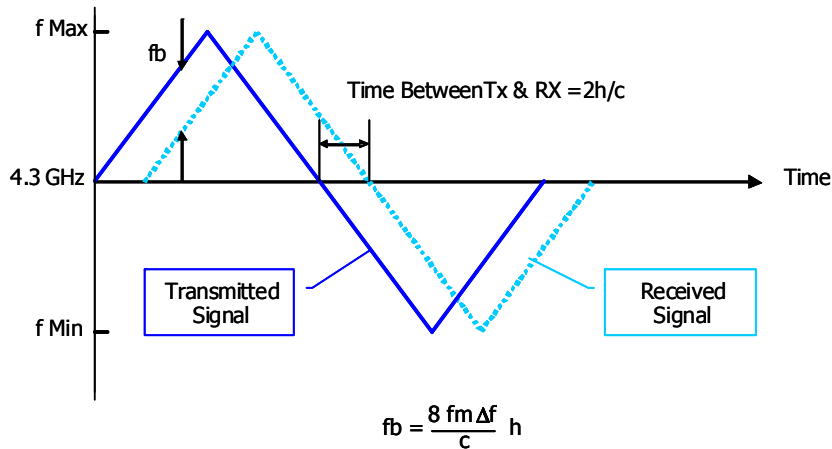

Fig. 6-3 Conventional FM/CW Sweep

The transmitter comprises a solid state oscillator, frequency modulated at typically 100-150 Hz rate. Although most of the power is radiated from a directional antenna, a sample is fed to a mixer to beat with the received signal. The beat frequency is usually less than 1 MHz. The echo is mixed with the transmitter sample in a stripline balanced mixer to produce the beat frequency.

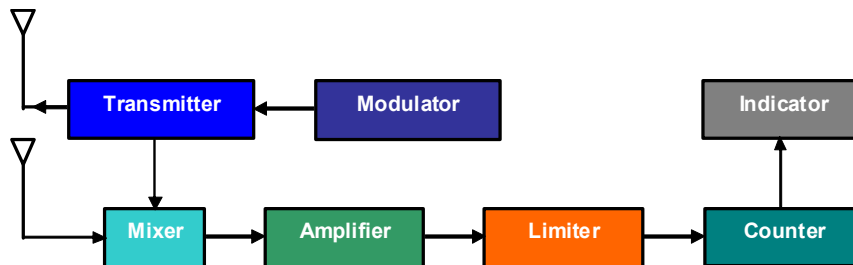

Fig. 6-4 Conventional FM/CW Radio Altimeter Block Diagram

The beat signal is filtered first, then amplified and limited. A frequency counter drives the altitude indicator and various altitude alarms if required. Transmission delays, due mainly to the cables connecting the antennas to the electronics of the radio altimeter, are known as AID (Aircraft Installation Delay). The AID is subtracted from the measured altitude. For a 0 to 2500 ft altimeter with a Δf of 100 MHz, fm of 200Hz and an AID of 57 ft, the range of the beat frequency fb would be 4.56 to 204.56 kHz. This wide bandwidth could be reduced thereby improving receiver sensitivity, if a constant beat frequency were maintained hence the development of the constant difference frequency altimeter.

Main Characteristics: Conventional FM/CW Radio Altimeter

- Continuous Wave (not pulsed), constant amplitude
- Carrier Frequency 4300 MHz (allocated to Radio Altimeter)
- Frequency Modulated with triangular waveform, Sweep Rate 50 to 160 Hz
- Deviation is +/- 50 to 70 MHz (200kHz bandwidth receiver required)
- Transmission continuously varies between 4250 MHz and 4350 MHz
- Height errors due to vertical movement Doppler shift, are averaged over both slope.

6.1.3.B Constant Difference Frequency (CDF) FM/CW

The Constant Difference Frequency is similar to conventional FM/CW altimeter at the RF end. The beat frequency amplifier is narrow band, with gain controlled by the loop so it increases with altitude. A tracking discriminator compares the beat frequency fb with an internal reference fr . If the two are not the same, an error signal is fed to the loop control. The outputs of the loop control are used to set the modulator frequency, f_m (or amplitude if deviation, Δf , is controlled), to set the gain of the amplifier and to drive the indicator. The change in f_m (or Δf) is such as to make $fb = fr$. Any change in height will lead to a change in fb and resultant loop action to bring fb back to the required rate; in doing so the indicator feed will change. If fb and fr are far removed, search action is instigated whereby the modulator frequency (or Δf) is made to sweep through its range from low to high until lock on is received.

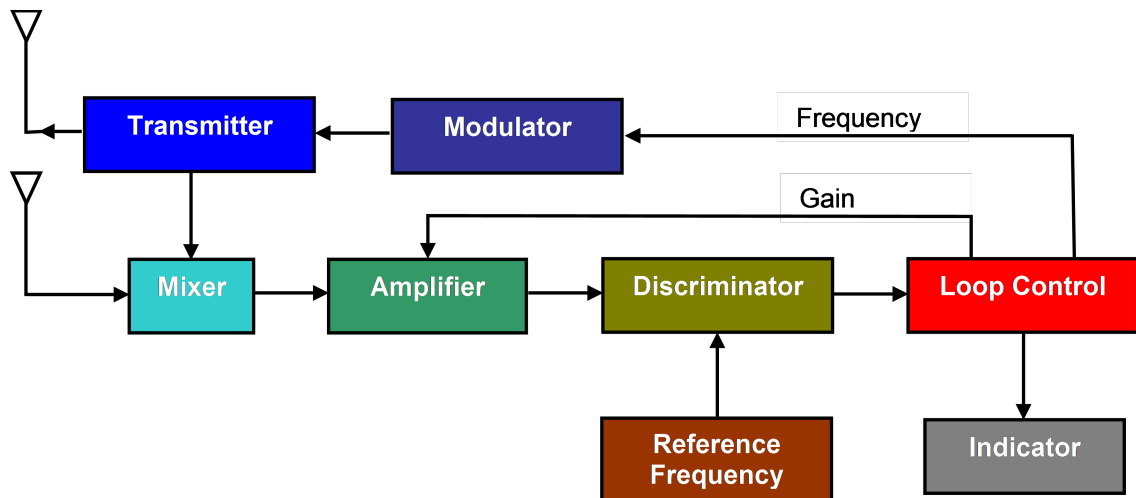

Fig. 6-5 CDF FM/CW Radio Altimeter Block Diagram

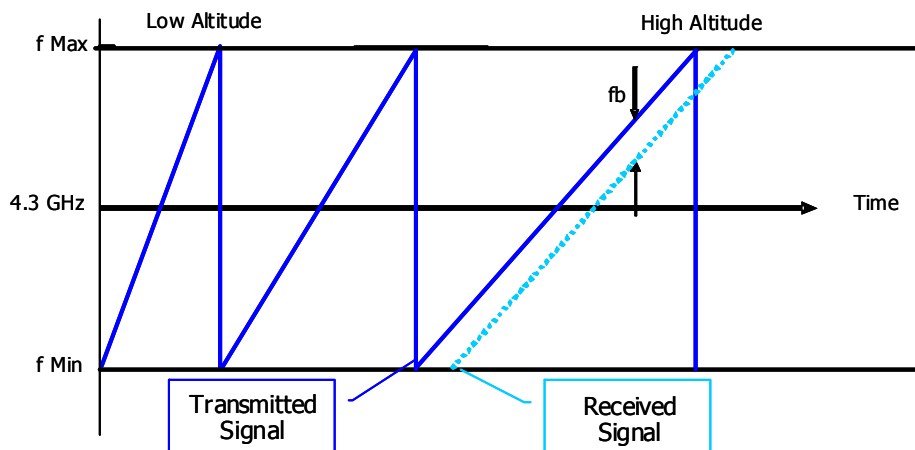

Fig. 6-6 CDF FM/CW Sweep

Characteristics: CDF FM/CW Radio Altimeter

- Continuous Wave (not pulsed), constant amplitude
- Carrier Frequency 4300 MHz (allocated to Radio Altimeter)
- Frequency Modulated with triangular waveform, Sweep Rate is proportional to altitude, maintaining a constant beat frequency.
- Constant beat frequency allows narrow bandwidth receiver

6.1.3.C Antennas

Separate antennas are provided for Transmit and Receive. The TX antenna is mounted forward and the RX Aft on the lower fuselage. Typical spacing minimum TX/RX antenna spacing is 20°. The antennas are directional types, either patches or horns, that gain typically 10 dBi, with a beam-width of 20° to 40° to accommodate aircraft pitch of up to 20° and up to 30° of roll.



Fig. 6-7 Triple LRRRA Antenna Installation (ARINC square patch type)



Fig. 6-8 LRRRA Antenna Installation (recessed horn type)

6.1.3.D Aircraft Installation Delay (AID)

The radio altimeter is calibrated to read main landing gear wheel height above the ground while in the pitch attitude associated with a normal configuration and normal approach speed at the runway threshold.

In most large transports, this means that the radio altimeter antenna, located forward of the main wheels on the fuselage, is quite a bit higher than the main wheels (Fig. 6-9). When the main wheels touchdown, the radio altimeter should indicate 0 ft. However, the antenna is still several feet above the ground. As the airplane de-rotates and the nose touches down, the radio altimeter antenna continues to descend below 0 ft, for example on the B-767/757, the radio altimeter typically reads -8 ft on the ground.

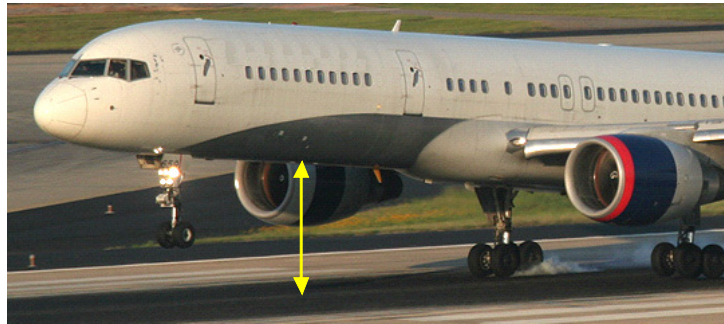

Fig. 6-9 Radio Altimeter Antenna Height at Touchdown

The Aircraft Installation Delay (AID), provides the means to ensure the radio altimeter indicates 0 ft at touch down. The AID consists of a standard length of TX and RX RF antenna feeder cable. For ARINC installations, standard AIDs are 20, 40, 57 and 80 ft depending on the size of the aircraft. The B-737, for example, uses a 57 foot AID, that's the distance from the transmit port of the transceiver, through the cable and antenna, to the ground at touchdown angle, and back through the receive antenna and cable to the receive port of the transceiver. It is usual for any extra cable length to be coiled in the belly of the plane. Jumper pins in the LRRA installation rack are used to select AID for the specific aircraft installation, introducing the necessary altitude offset in the LRRA LRU for 0 ft.

6.1.3.E Radio Altitude Digital Indicators

There are separate analog indicators for barometric and radio altitude, the EFIS (Electronic Flight Instrumentation System) displays utilized on digital flight decks, are capable of displaying both barometric and radio altitude, refer to Fig. 6-10. Normally, radio altitude is only displayed below 2,500 ft. In a precision approach, the Decision Height is set dependant on the landing category of the aircraft. When the Decision Height is reached, an audible warning is also given and the pilot must make the decision to either continue with the landing approach or go around.

Category I (CAT I)

A precision instrument approach and landing with a decision height not lower than 200 ft (61 m) above touchdown zone elevation and with either a visibility not less than 800 m (2,625 ft) or a runway visual range not less than 550 m (1,804 ft).

Category II (CAT II)

Category II operation: A precision instrument approach and landing with a decision height lower than 200 ft (61 m) above touchdown zone elevation but not lower than 100 ft (30 m) and a runway visual range not less than 300 m (984 ft) for aircraft category A, B, C and not less than 350 m (1,148 ft) for aircraft category D.

Category III (CAT III) is further subdivided

Category III A

A precision instrument approach and landing with: a) a decision height lower than 100feet (30 m) above touchdown zone elevation, or no decision height (alert height); and b) a runway visual range not less than 200 m (656 ft).

Category III B

A precision instrument approach and landing with: a) a decision height lower than 50 ft (15 m) above touchdown zone elevation, or no decision height (alert height); and b) a runway visual range less than 200 m (656 ft) but not less than 75 m (246 ft). Autopilot is used until taxi-speed. In the United States, FAA criteria for CAT IIIb runway visual range allows readings as low as 150 ft.

Refer to Fig. 6-10. The decision height source used may be radio altitude or barometric altitude. Barometric altitude is displayed on the right hand tape. The green arrow on the altitude scale is the barometric decision height indicator, which is active when filled with a solid green. In this example the Radio Altimeter is the active source and a Decision Height of 100 ft, is displayed alongside the Radio label.



Fig. 6-10 Typical EFIS

6.1.3.F Radio Altitude Analog Indicators

Fig. 6-11 shows an example of a Dial type analog indicator. The altitude scale is non-linear. Notice that as much space on the dial is devoted to 0 to 100 ft. as is used for 1,000 to 2,500 ft. The low end of the scale, when near the ground, is where the greatest resolution is needed.

In this example, the green indicator shows that the Radio Altimeter is coupled to the auto-land system. The green indicator light switches to red when descending below the altitude set by the DH bug. In a CAT I or CAT II approach, the aircraft is manually flown on to the runway from the DH point. The autopilot must be switched off to allow manual flying. Fig. 6-12 shows an example of a moving tape type analog indicator.

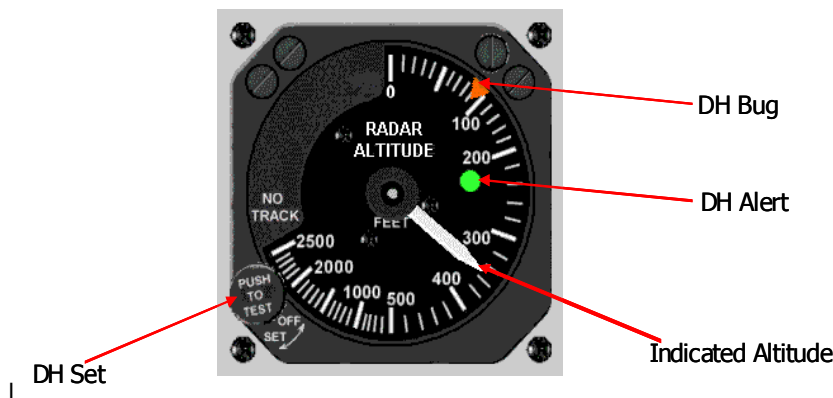

Fig. 6-11 Analog Indicator Dial Type

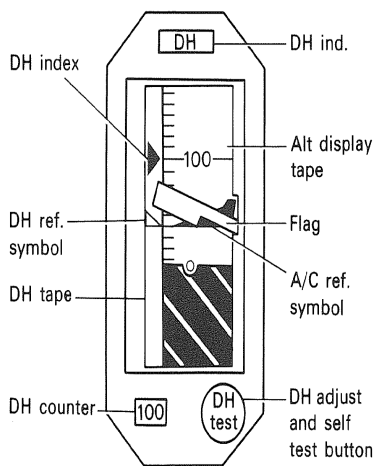

Fig. 6-12 Analog Indicator Moving Tape Type

6.1.4 Pulse Radio Altimeter Systems

The Pulse Radio Altimeter System's main (but not exclusive) application is for military aircraft. Typically these operate at a frequency of 4.3 GHz, pulse width of 25 to 75 ns, PRF 8 to 18 kHz and TX power of between 5 to 100 W peak. An example is the AN/APN-209, which has been the Standard Radar Altimeter System for U.S. Army helicopter applications in production for the last 30 years. Hover-hold performance with digital altitude and analog displays are compatible with Night Vision Goggles (NVGs). The system includes the receiver-transmitter, integrated or remote height indicators, and various antenna options.

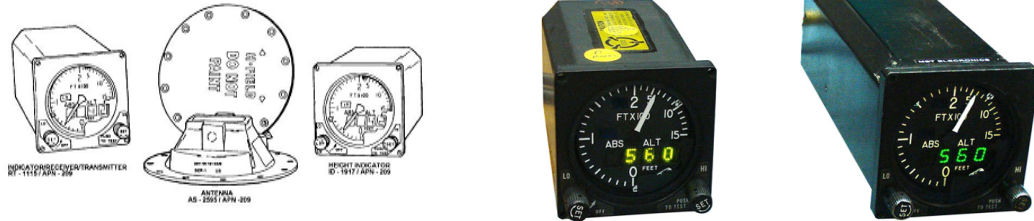

Fig. 6-13 AN/APN-209 Pulse Radio Altimeter

Altitude is determined by measuring the time delay between the transmitted pulse and the received pulse, reflected from the ground. These are medium to high range systems. Some variations have the advantage that they can use one antenna for transmit and receive.

The height given by half product of the elapsed time and the speed of light is $h = ct/2$.

h = Aircraft Altitude

c = speed of light

t = elapsed time between transmission and reception

Refer to Fig. 6-14. A time reference signal, t_0 , is fed from the transmitter to initiate a precision ramp generator. The ramp voltage is compared with the range voltage, VR , which is proportional to the indicated height. When the ramp voltage reaches VR , a track gate pulse is generated and fed to gate B and an elongated gate pulse is fed to gate A. The detected video pulse is also fed to gates A and B. A further gate pulse is fed to the A.G.C. circuits.

Unless a reliable signal is detected within the elongated gate pulse, the track/search circuit will signal the commencement of a search cycle and break the track loop by removing its reference current feed. During search, the search generator drive to the range circuit ensures that VR , starting from a voltage representing zero feet, runs out to a voltage representing 2,500 ft. The search cycle repeats until a reliable signal (five or six pulses) is received when the track loop becomes operational.

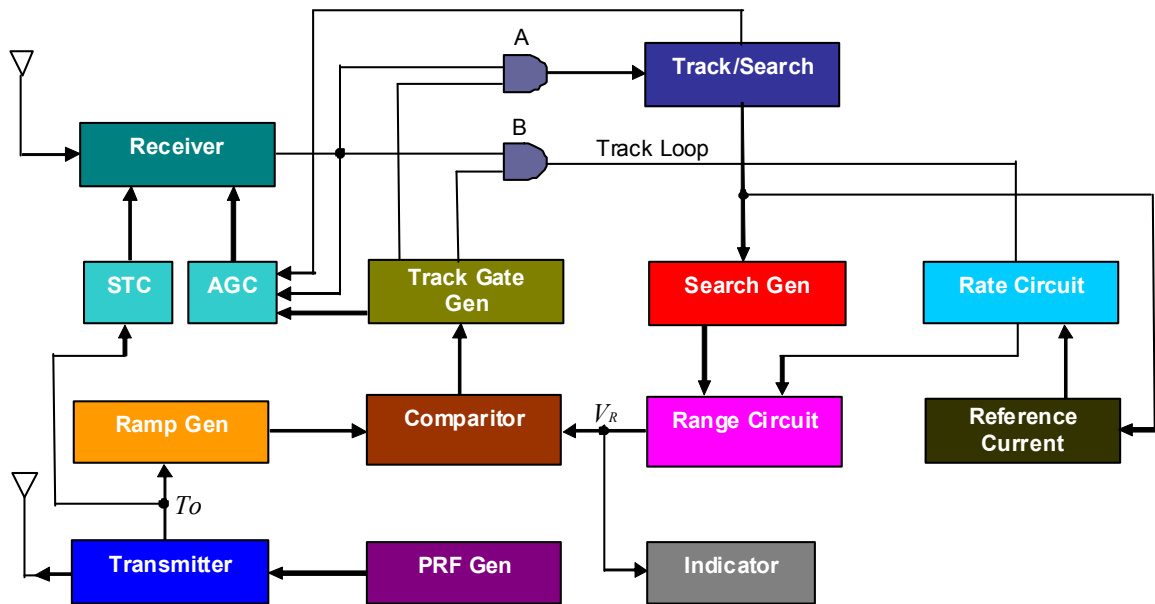

Fig. 6-14 Pulse Radio Altimeter Block Diagram

During track, the overlap of the track gate pulse and video pulse, determines the magnitude of a current which is compared with a reference (offset) current. Where the two currents are equal, the output of the rate circuit (integrator) is zero, otherwise a positive or negative voltage is fed to the range circuit. The range circuit (integrator) adjusts its output voltage, V_R , if its input is non-zero. Since V_R determines the timing of the track gate pulse, any change in V_R , will cause the previously mentioned overlap to alter until such time as the loop is nulled, i.e. overlap current = reference current. Any change in height will therefore result in a change in V_R , to bring the loop back to a null condition.

Automatic Gain Control (A.G.C.) and Sensitivity Time Control (S.T.C.) are fed to the receiver where they control the gain of the I.F. amplifiers. During search the A.G.C. circuits monitor the noise output of the receiver and adjust its gain so as to keep noise output constant. The S.T.C. reduces the gain of the receiver for a short time, equivalent to say 50 ft after transmission and then its control decreases linearly until a time equivalent to say 200 ft. This action prevents acquisition of unwanted signals, such as leakage, during the search mode.

During track, the A.G.C. maintains the video signal in the A.G.C. gate at a constant level. This is important to ensure precise tracking of the received signal since any variation in amplitude would cause the area of overlap to track gate and video signals to change. At low heights on track the A.G.C. reduces the receiver gain, so helping to avoid the effects of leakage. When the height increases the signal leakage signal is gated out, giving time discrimination.

6.1.5 Systems Coupled With Radio Altimeter

Auto-land Systems

The Radio Altimeter provides Auto-land Systems with altitude trip inputs to initiate functions and radio height information for generation of trip signals within the auto-flare computer. Typically the critical systems are dual or triple configurations.

Typical Auto-land Events

140 ft (RA Trip)

- Radio Altimeter Interlock Switched In
- Progressively Reduce Gain of Glide Slope Amplifier In Pitch Channel

120 ft (Auto-flare Computer)

- Preparatory Functions

90 ft (RA Trip)

- Check 140 ft Operation

50 ft (Auto-flare Computer Trip)

- Glide Slope Signal Discontinued
- Throttle Closure Initiated
- Pitch Demand Maintains Correct Descent Rate

20 ft (Auto-flare Computer Trip)

- Rudder Servo Disconnected
- Ailerons Centered

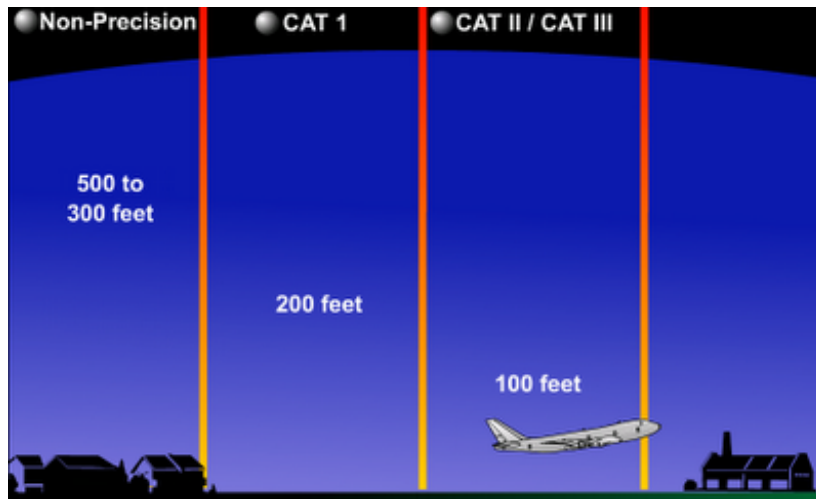

Fig. 6-15 Approach Types

6.1.5.A Terrain Awareness and Warning System (TAWS)

TAWS aims to prevent controlled flight into terrain. The systems in current use are known as ground proximity warning system (GPWS) and enhanced GPWS. The U.S. FAA developed the TAWS term to encompass all current and future systems which meet the relevant FAA standards. New systems, with different names than GPWS and EGPWS, may be developed which meet TAWS objectives.



Fig. 6-16 Terrain Awareness and Warning System

A TAWS works by using digital elevation data and airplane instrumental values, to predict if a likely future position of the aircraft intersects with the ground. The flight crew is provided with earlier aural and visual warning of impending terrain, forward looking capability and continued operation in the landing configuration.

6.1.5.B Ground Proximity Warning System (GPWS) and Enhanced Ground Proximity Warning System (EGPWS)

The GPWS/EGPWS is an important safety system that relies on altitude input from the LRRR. GPWS/EGPWS alerts the flight crew when one of the following thresholds are exceeded between 50 and 2,450 ft radio altitude:

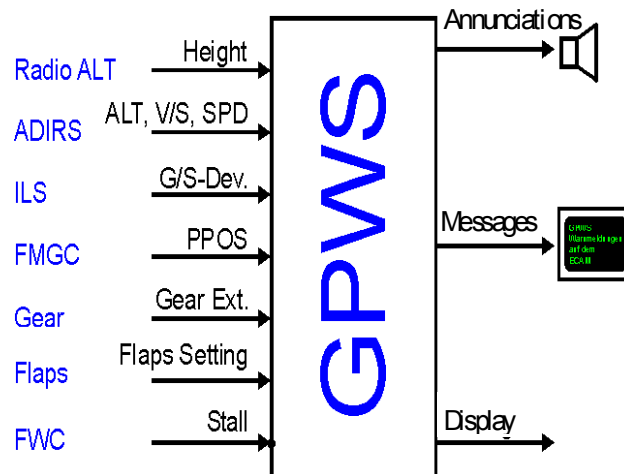

Fig. 6-17 GPWS Inputs

- Mode 1** - Excessive Descent Rate ["Pull Up" "Sink Rate"]
- Mode 2** - Excessive Terrain Closure Rate ["Terrain" "Pull Up"]
- Mode 3** - Altitude Loss After Take - Off or Go Around or with a high power setting ["Don't Sink"]
- Mode 4** - Unsafe Terrain Clearance ["Too Low - Terrain" "Too Low - Gear" "Too Low - Flaps"]
- Mode 5** - Below Glideslope Deviation Alert ["Glideslope"]
- Mode 6** - Excessively Steep Bank Angle ["Bank Angle"]
- Mode 7** - Windshear Protection ["Windshear"]

THIS PAGE INTENTIONALLY LEFT BLANK.

Chapter 7 - Product Specifications

7.1 USER INTERFACE

Display: 12" Color LCD, sunlight readable with back light.

Controls: Touch screen

TX/RX Direct Connection Ports:

Connector Type:	TNC
Impedance:	50 Ω
SWR:	UUT:RX 2.5:1 max
	UUT:TX 1.5:1 max

7.2 GENERATOR (UUT:RX)

LINEAR ALTITUDE SIMULATION

Range (FMCW):	-20 to 5,500 ft
Range (Pulse):	50 ft ¹ to 5,500 ft
Resolution:	1 ft Increments
Accuracy (FMCW):	+/- 1.5 ft or 2% RMS, whichever is greater
Accuracy (Pulse):	+/- 1.5 ft or 2% RMS, whichever is greater

LINEAR ALTITUDE RATE

Range:	1 to 120,000 fpm
Resolution:	1 fpm increments

TEST CABLE (Automatic Calibration)

Length:	1 to 100 ft
Loss:	0 to 9.9 dB

AID (Direct Connect)

Fixed Selectable:	0, 20, 40, 57 or 80 ft
User Entered:	0 to 99 ft

OFFSET (coupler connect)

Range:	-25 to 100 ft
---------------	---------------

GENERATOR (cont)

RF LEVEL (cont)

Manual Mode (FM/CW)

Range: -84 to 9 dBm ²

Manual Mode (Pulse)

Range: -76 to 17 dBm ²

Accuracy: +/- 4 dB

Auto Mode (ratio metric): Computed ³

RF Level Offset (auto mode): -20 to 20 dB

RF Path Loss Simulation: 0 to 5,500 ft ⁴

Frequency Stability: +/- 1 ppm

¹ Minimum achievable altitude is dependent on cable length being used for simulation.

² The range is dependent upon cable loss, coupler loss, and external attenuation.

³ The RF level is computed based on UUT:TX power and the following losses: altitude, scattering, offsets, cables, couplers, and external attenuation.

⁴ External attenuation may be required to achieve appropriate RF level at higher altitudes.

7.3

RECEIVER (UUT:TX)

RF Input Frequency

Range: 4.20 to 4.40 GHz

FM/CW and CDF FM/CW Radio Altimeter

Frequency Measurement:

Range: 4.20 to 4.40 GHz

Accuracy: +/- 5.0 MHz

Power Measurement

Range: 4 mW (6 dBm) to 2 W (33 dBm)

Accuracy: +/- 2 dB

FM Sweep Rate Measurement

Range: 50 to 400 Hz

Accuracy: +/- 5 Hz

FM Deviation

Range: +/- 20 to 100 MHz

Accuracy: +/-5 MHz

RECEIVER (cont)

PULSE RADIO ALTIMETER

Frequency Measurement

Range: 4.20 to 4.40 GHz

Accuracy: +/- 10 MHz

Pulse Power Measurement

Range: 1 W (+30 dBm) to 300 W peak (+54 dBm)

Accuracy: +/- 2dB

Pulse Width Measurement

Range: 20 ns to 400 ns

Accuracy: +/- 10 ns

Pulse PRF Measurement

Range: 2 to 30 kHz

Accuracy: +/- 5%

7.4 MASTER OSCILLATOR

Frequency: 10 MHz nominal

Temperature Stability: ± 1 ppm

Aging Rate: +1 ppm/yr, ± 5 ppm/ 10 yr

Uncertainty: ± 1 ppm

7.5 RELIABILITY

Calculated to be >30,000 hours at 25 degrees C based on Telcordia SR-332 prediction models. See detailed report for further info.

7.6 COUPLER

Qty: 2 (1 x for TX, 1 x for RX)

Type: Patch in RF Absorbent Foam

Coupling: -15 dB typical at 4.3 GHz.

Isolation: > 25 dB at 4.35 GHz

Coupling Loss Compensation: 0 to 19.9 dB

7.7 BATTERY

Type:	Lithium Ion, Removable Pack
Voltage:	14.4 VDC or 14.8 VDC
Capacity:	6.94 AH
Duration:	4 Hrs
Charging temperature range:	0° to 45° C.

7.8 PHYSICAL CHARACTERISTICS

Height:	10.63 inches (27.0 cm)
Width:	13.97 inches (35.5 cm)
Depth:	3.425 inches (8.7 cm)
Weight (Test set only):	<10 lbs. (4.5 kg)

7.9 ENVIRONMENTAL

Operational Temperature:	5° to 40° C
Storage Temperature:-	-20° to 71° C when no battery is installed
Altitude:	10,000 meters

Test Set Certifications

Operational Humidity:	MIL-PRF-28800F Class 2
Storage Humidity:	MIL-PRF-28800F Class 2
Vibration Limits:	MIL-PRF-28800F Class 2
Shock, Function:	MIL-PRF-28800F Class 2
Transit Drop:	MIL-PRF-28800F Class 2
Drip Proof:	MIL-PRF-28800F Class 2
Dust:	MIL-PRF-28800F Class 1
Salt:	MIL-PRF-28800F Class 1
Explosive Atmosphere:	MIL-PRF-810F Method 511.4, Procedure 1
Safety Compliance:	UL-61010:2001 CSA 22.2 No 1010.1 WEEE ROHS EMC
Emissions:	MIL-PRF28800F Class 2 EN 61326:1998 Class A EN 61000-3-2 EN 61000-3-3
Immunity:	MIL-PRF28800F Class 2 EN 61326:1998Class A

ENVIRONMENTAL (cont)

External AC-DC Converter Certifications

Safety Compliance:	UL 1950 DS CSA 22.2 No. 234 VDE EN 60 950
EMI/RFI Compliance:	FCC Docket 20780 Curve "B"
EMC:	EN 61326

External AC to DC Converter

Use:	Indoors
Altitude:	≤ 10,000 m
Operating Temperature:	5° to 40° C
Storage Temperature:	-20° to 71° C

Transit Case Certifications

Drop Test:	FED-STD-101C Method 5007.1 Paragraph 6.3, Procedure A, Level A
Falling Dart Impact:	ATA 300 Category I
Vibration, Loose Cargo:	FED-STD-101C Method 5019
Vibration, Sweep:	ATA 300 Category I
Simulated Rainfall:	MIL-STD-810F Method 506.4 Procedure II of 4.1.2
FED-STD-101C:	Method 5009.1 Sec 6.7.1
Immersion:	MIL-STD-810F Method 512.4

THIS PAGE INTENTIONALLY LEFT BLANK.

Appendix A - Pin-Out Tables

A.1 ETHERNET CONNECTOR

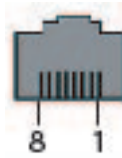

Pin Number	Signal Type	Signal Type	Function
1	Data	Transmit +	Ethernet TX +
2	Data	Transmit -	Ethernet TX -
3	Data	Receive +	Ethernet RX +
4	NC	NC	
5	NC	NC	
6	Data	Receive -	Ethernet RX -
7	NC	NC	
8	NC	NC	

Table A-1 Ethernet Pin-Out Diagram

A.2 USB HOST 1 CONNECTOR

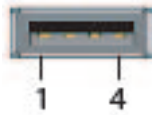

Pin Number	Signal Type	Signal Type	Function
1	Power	VCC	USB Power
2	Data	Data -	USB Data -
3	Data	Data +	USB Data +
4	GND	GND	Ground

Table A-2 USB Host 1 Pin-Out Diagram

A.3 USB HOST 2 CONNECTOR



Pin Number	Signal Type	Signal Type	Function
1	Power	VCC	USB Power
2	Data	Data -	USB Data -
3	Data	Data +	USB Data +
4	GND	GND	Ground

Table A-3 USB Host 2 Pin-Out Diagram

A.4 USB OTG CONNECTOR

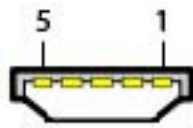

Pin Number	Signal Type	Signal Type	Function
1	Power	VCC	USB Power
2	Data	Data -	USB Data -
3	Data	Data +	USB Data +
4	Control	ID	Identify
5	GND	GND	Ground

Table A-4 USB OTG Pin-Out Diagram

A.5 DC POWER CONNECTOR



Pin Number	Signal Type	Signal Type	Function
Inner	Power	VCC	HHCP Power
Outer	GND	GND	Ground

Table A-5 DC Power Connector Pin-Out Diagram

A.6 AUX CONNECTOR

Currently not in use.

Appendix B - Terminology

Term	Description
AID	<p>Aircraft Installation Delay. Feeder cable(s) of a specific length that standardizes the total distance from the radio altimeter LRU to the ground at touch-down. The ARINC standardized distances are 20, 40, 57 or 80 ft. It is normal for surplus feeder cable to be coiled in the fuselage. The distance offset that the altimeter compensates for, to set 0 ft indication with the aircraft at touch-down prior to de-rotation. This is determined by jumper wire selection in the installation rack.</p>
Altitude Rate	The rate of climb or descent. Also known as Vertical Speed
Altitude Trip	Usually relating to ARINC 552 radio altimeters, a relay switched output to control/signal connected systems such as auto-land, that a specific altitude has been reached.
Approach	The landing phase of a flight
ARINC	<p>Aeronautical Radio Incorporated. A U.S. based aeronautical standards organization, originally owned collectively by several airlines. ARINC standards mainly address the system interface, whereas RTCA standards address system design.</p>
ARINC 552	An earlier ARINC standard defining the interface of analog radio altimeters. Typically used in air transport installations.
ARINC 707	A later ARINC standard defining the interface of digital radio altimeters. Typically used in air transport applications
Audio Frequency Altitude	An Audio Frequency that is proportional to altitude.
CDF FM/CW	<p>Constant Difference Frequency - Frequency Modulated Continuous Wave A Thales proprietary technique that alters the sweep rate in proportion to altitude maintaining a constant difference or beat frequency in a narrow bandwidth receiver</p>
DC Altitude	A DC voltage that is proportional to altitude, defined by ARINC-552. Used to drive analog altitude indicators and other sub systems.
Decision Height	An altitude, at which the pilot is alerted by the radio altimeter. Typically used to make landing decisions
De-rotation	The point after touch down when the pilot lowers the nose of the aircraft so the front wheels touch down.

Appendix B

Term	Description
DH Bug	The decision height setting pointer on dial type analog altitude indicators. Also known as the DH index on analog tape indicators and EFIS
DH Set	The knob on an analog altitude indicator that the pilot uses to set the DH bug. Also known as DH adjust.
EFIS	Electronic Flight Instrument System
Feeder Cable	The RF Coax Cable linking either the transmitter port to the TX antenna or the receiver port to the RX antenna
Flag	A red mechanical bar or a graphical bar that obscures part of the altitude display to indicate that altitude information is not available or unreliable.
FM/CW	Frequency Modulated Continuous Wave Triangular wave frequency modulated technique that produces a difference or beat frequency in a wide bandwidth receiver, that is proportional to altitude
FM Deviation	The limits of deviation of the 4.3 GHz (center carrier) signal, during frequency modulation, expressed in MHz.
Go- Around	A missed approach procedure
Installation Rack	The mounting tray for the LRU that accommodates a mating connector for all discrete and RF signals. The aircraft wiring connects to the installation rack, which typically provides screw down retention for the LRU that allows easy removal.
Integrity Monitor	The Built In Test Equipment that monitors correct operation of an LRU and advises module failure either by dedicated indicators on the LRU front panel or via a BITE word from the test port.
Label 164	ARINC 429 binary data word for radio height. An altitude data output format for ARINC -707 radio altimeters. May also be output on ARINC-707 radio altimeter test ports.
Label 165	ARINC 429 BCD data word for radio height. An altitude data output format for ARINC -707 radio altimeters. May also be output on ARINC-707 radio altimeter test ports.
Leg	A linear altitude ramp, either climbing, level altitude or descending. 1. If climbing or descending the ramp is defined by start altitude, stop altitude and altitude rate. 2. If level (start altitude= stop altitude), the ramp is defined by duration.
Loop Gain Margin	The reflected signal amplitude seen at the radio altimeter receiver that is X dB's above the receiver MDS
LRRA	Low Range Radio Altimeter. Range typically up to 8,000 ft
LRU	Line Replaceable Unit. Would normally refer to the radio altimeter transmitter/receiver unit however, an indicator is also an LRU.

Appendix B

Term	Description
MDS	Minimum Discernible Signal Level. A term used to express radar receiver sensitivity in -dBms.
Profile	A sequence of legs forming a simulated flight path i.e. approach.
Pulse Radio Altimeter	The altimeter measures the time delay between a transmitted RF pulse and the reply from the ground.
Sweep Rate	The rate of the triangular frequency modulation of an FM/CW radio altimeter expressed in Hz. This is usually constant for a given system. CDF FM/CW systems will have a saw tooth frequency modulation, where the sweep rate is proportional to altitude.
Test Port	A port provisioned on some radio altimeters, that may provide the following. 1. BITE data output 2. Radio Height in the form of DC altitude, Audio Frequency Altitude or Digital Altitude. 3. Analog trips 4. System flags
UUT	Unit Under Test

THIS PAGE INTENTIONALLY LEFT BLANK.

Index

A		O	
Appendix A		Operation	
Pin-Out Tables		Installation	2-2
.	A-1	Ventilation Requirements	2-2
Appendix B		Introduction	2-1
Terminology	B-1	Power Requirements	2-1
		Battery Recharging	2-2
		General	2-1
	D	Operations	
Description		Controls and Connectors	2-3
Equipment Capabilities and Features	1-1	Front Panel	2-3
Capabilities	1-2	Rear Panel	2-3, 2-5
Features	1-2	Defining Parameters	2-11
Utilities	1-2	Data Slew Bar	2-12
Introduction	1-1	Drop-down Menus	2-12
	F	Entering Numeric Values	2-11
Functions		Locked Fields	2-13
Introduction	3-1	Numeric Keypad	2-11
Status Bar Alert Messages	3-21	Rotary Knob	2-12
Test Set Functions	3-1	Selectable Units	2-13
Profile Management	3-8	Operating Procedures	2-6
Load Profile Function Window	3-10	Power Off Test Set	2-6
Profile Setup Function Window	3-5	Power On Test Set	2-6
Add Leg #	3-7	User Interface Components	2-7
Edit Leg #	3-7	Function Keys	2-8
Simulation Function Window	3-1	Function Window Icons	2-10
Auto RF Level Test	3-1	Function Windows	2-9
Pulse Radio Altimeters	3-4	Launch Bar	2-7
Test Setup	3-11		P
Settings Storage	3-14	Principles of Operation	6-1
Test Setup Function Window	3-11, 3-19	ALT-8000	6-1
	I	FM/CW Radio Altimeters	6-3
Installation		AID	6-7
Bench Top	2-2	Antennas	6-6
	M	Constant Difference Frequency	6-5
Maintenance		Conventional FM/CW Radio Altimeters	6-4
External Cleaning	5-1	Radio Altitude Analog Indicators	6-9
Introduction	5-1	Radio Altitude Digital Indicators	6-7
Maintenance Procedures	5-2	Pulse Radio Altimeter Systems	6-10
Battery Replacement	5-2	Radio Altimeters	6-2
Software Update	5-3	Systems Coupled With Radio Altimeters	6-12
Visual Inspections	5-1	GPWS and EGPWS	6-13
Maintenance Procedures		TAWS	6-13
Battery Replacement	5-2	Product Specifications	7-1
		Environmental	7-4

T

Testing

Antenna Coupler Installation and Connection	4-4
Antenna Couplers and Installation Kit . . .	4-1
Feeder Connection	4-5
Introduction	4-1
Setup	4-6
Linear Altitude Ramp Test	4-9
Profile Altitude Test	4-13
Profile Creation	4-11
UUT Parametric Tests	4-14
Testing Identifying Installed Software Version	4-17

U

Upon Receipt	5-i
Checking Equipment	5-i
Standard Items	5-ii
Unpacking Test Set	5-i



**Part of CD# 88035 B0
June 2020
English**

VIAVI Solutions

North America:	1.844.GO VIAVI / 1.844.468.4284
Latin America	+52 55 5543 6644
EMEA	+49 7121 862273
APAC	+1 512 201 6534
All Other Regions:	viavisolutions.com/contacts